

Technical Data Sheet

High Power LED – 1W

EHP-A07/SUR01-P01

Features

- **feature of the device:** small package with high efficiency
- **View angle:** 120°.
- **high luminous flux output:** more than 28lm@350mA.
- **ESD protection.**
- **soldering methods:** SMT.
- **grouping parameter:** total luminous flux, dominant wavelength.
- **optical efficiency:** 37 lm/W.
- **Thermal resistance (junction to lead):** 17 K/W.
- **RoHS:** The product itself will remain within RoHS compliant version



Applications

- TFT LCD display backlight
- Decorative and entertainment illumination
- Signal and symbol luminaries for orientation signals (e.g. steps, exit ways, etc.)
- Exterior and interior automotive illumination

Materials

Items	Description
Housing	Heat resistant polymer
Encapsulating Resin	Clear silicone resin
Electrodes	Ag plating copper alloy
Die attach	Silver paste
Chip	AlGaInP

Dimensions

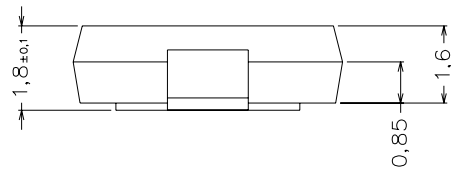
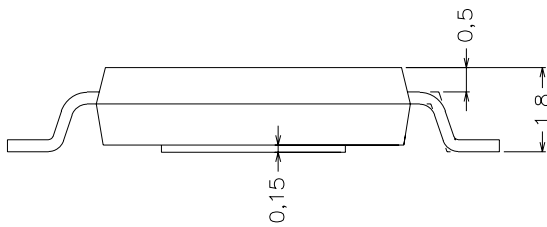
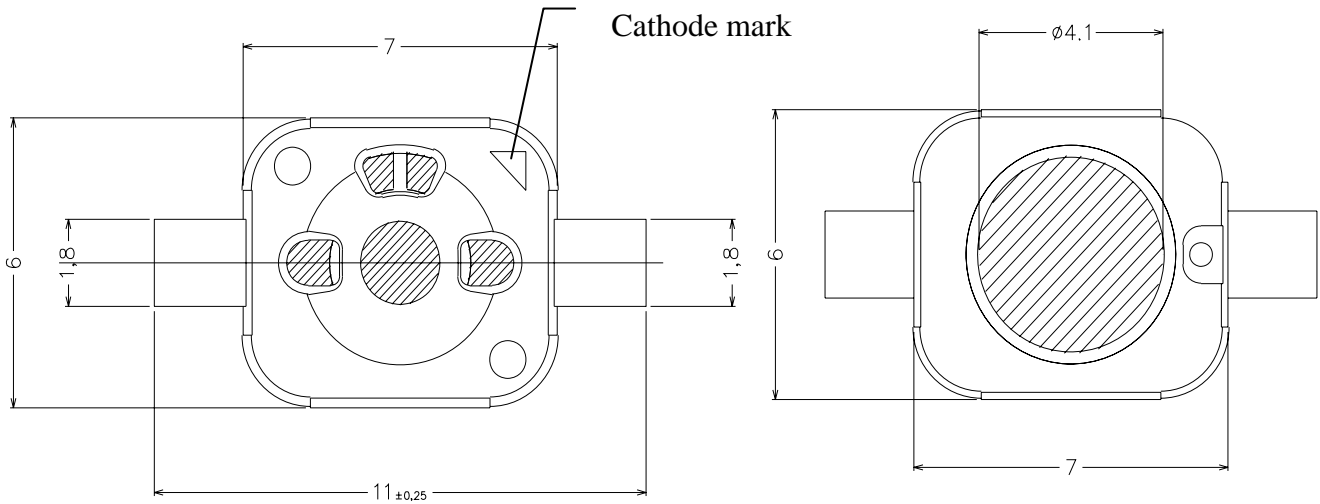

Recommended solder pad

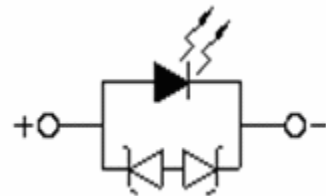
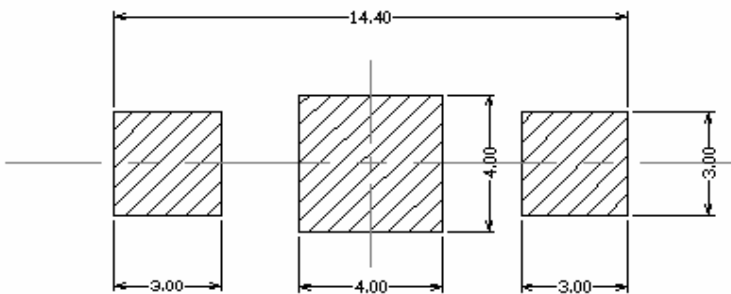

- Notes: 1. Dimensions are in millimeters
- 2. Tolerances unless dimensions ±0.25mm

Maximum Ratings ($T_{Ambient}=25^{\circ}\text{C}$)

Parameter	Symbol	Rating	Unit
Operating Temperature	T_{opr}	-40 ~ +100	$^{\circ}\text{C}$
Storage Temperature	T_{stg}	-40 ~ +100	$^{\circ}\text{C}$
Junction temperature	T_j	125	$^{\circ}\text{C}$
Forward Current	I_F	500	mA
Power Dissipation	P_d	1.5	W
Junction to heat-sink thermal resistance	R_{th}	17	K/W

Electro-Optical Characteristics ($T_{Ambient}=25^{\circ}\text{C}$)

Parameter	Bin	Symbol	Min	Typ.	Max	Unit	Condition
Luminous Flux ₍₁₎	J1	ϕ_v	23	----	27	lm	I _F =350mA
	J2		27	----	33		
	J3		33	----	39		
Viewing Angle ₍₂₎	----	$2\theta_{1/2}$	----	120	----	deg	
Forward Voltage ₍₃₎	U2	V_F	2.05	----	2.35	V	
	U3		2.35	----	2.65		
	U4		2.65	----	2.95		
Wavelength ₍₄₎	R3	λ_d	610	----	615	nm	
	R4		615	----	620		
	R5		620	----	625		
	R6		625	----	630		
	R7		630	----	635		

Note. 1. Luminous flux measurement tolerance : $\pm 10\%$

2. $2\theta_{1/2}$ is the off axis angle from lamp centerline where the luminous intensity is 1/2 of the peak value.

3. Forward Voltage measurement tolerance : $\pm 0.1\text{V}$

4. Wavelength measurement tolerance : $\pm 1\text{nm}$

Typical Electro-Optical Characteristics Curves

Relative Spectral Distribution,
 $I_F=350\text{mA}$, $T_{\text{Ambient}}=25^\circ\text{C}$

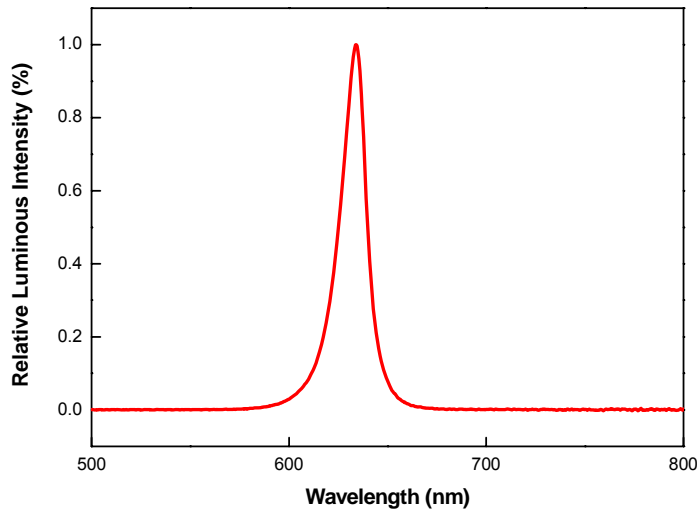

Forward Voltage vs Forward Current,
 $T_{\text{Ambient}}=25^\circ\text{C}$

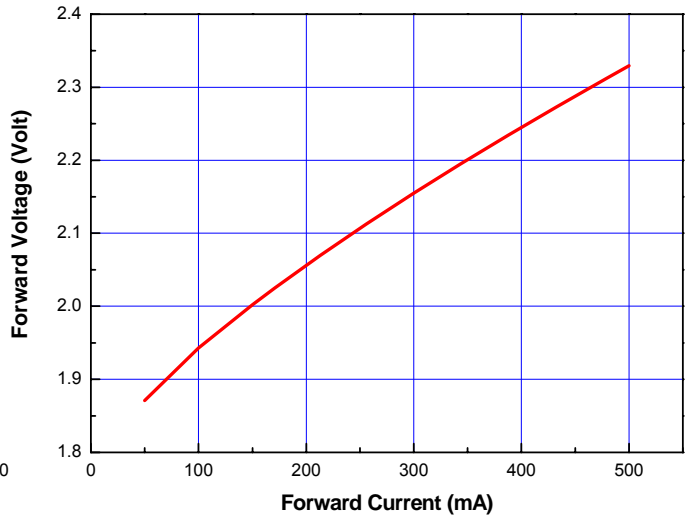

Relative Luminous Intensity vs Forward Current, $T_{\text{Ambient}}=25^\circ\text{C}$

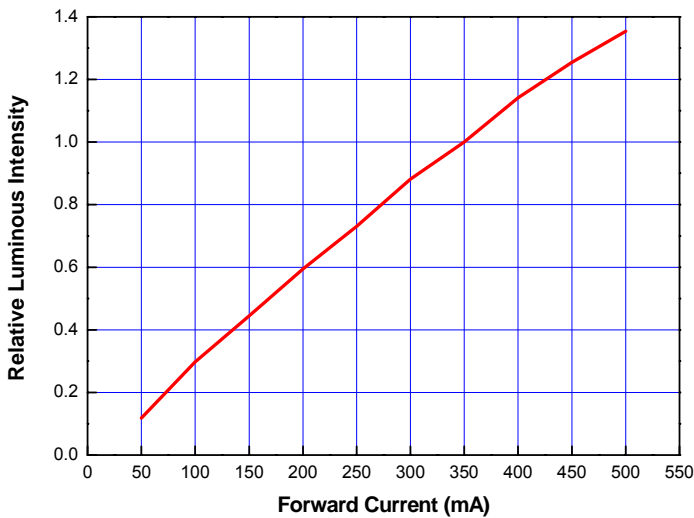

Forward Current Derating Curve,
 Derating based on $T_{\text{JMAX}}=125^\circ\text{C}$

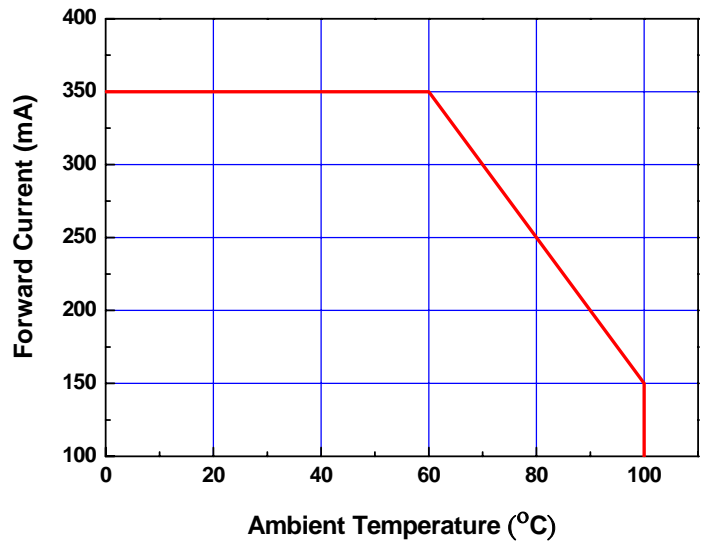

Typical Representative Spatial Radiation Pattern

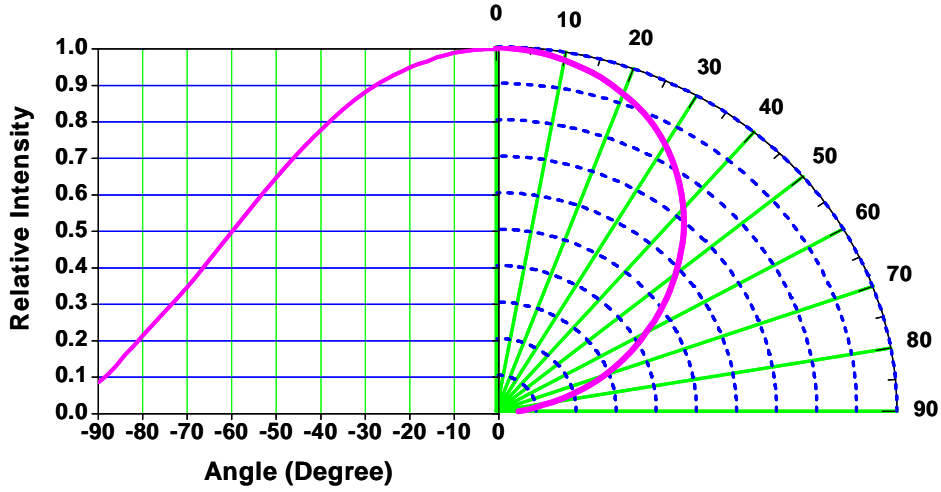

Label explanation

- CPN: Customer's Production Number**
- P/N : Production Number**
- QTY: Packing Quantity**
- CAT: Ranks**
- HUE: Peak Wavelength**
- REF: Reference**
- LOT No: Lot Number**
- MADE IN TAIWAN: Production Place**



Reel Dimensions

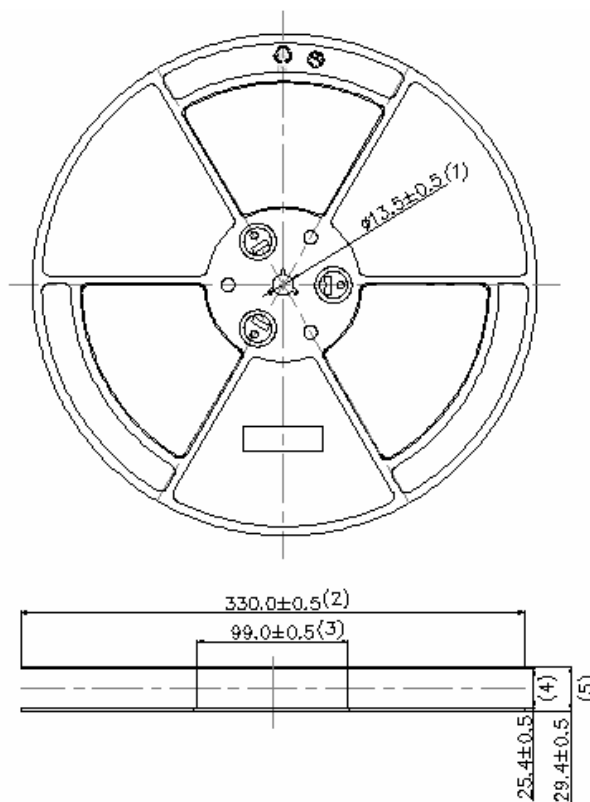

- Note: 1. Dimensions are in millimeters**
- 2. The tolerances unless mentioned is $\pm 0.1\text{mm}$**

Carrier Tape Dimensions: Loaded quantity 800 PCS per reel.

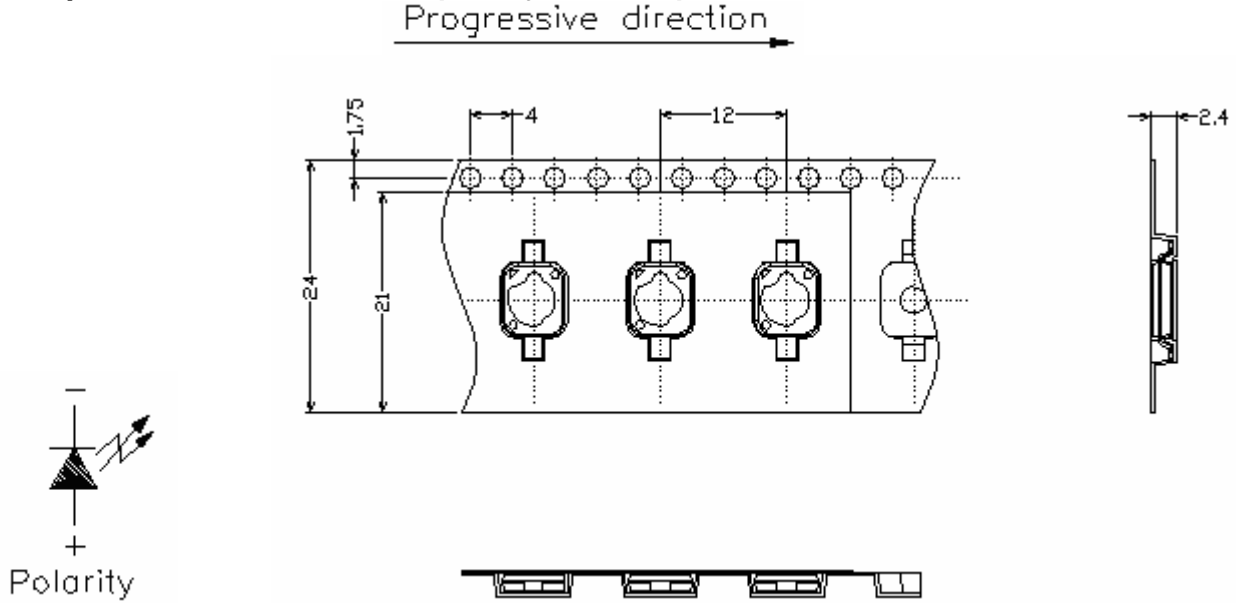

Note: 1. Dimensions are in millimeters

2. The tolerances unless mentioned is $\pm 0.1\text{mm}$

Moisture Resistant Packaging

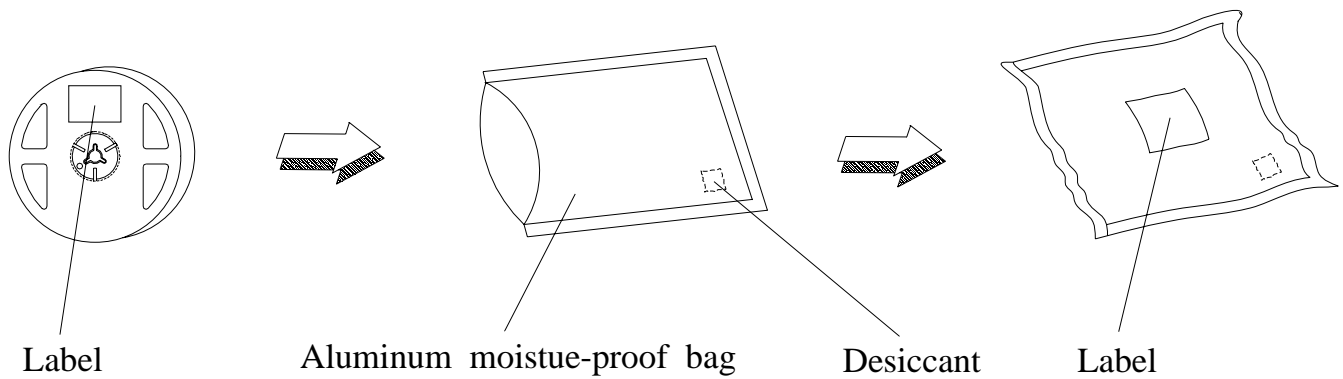

Reliability Test Items and Results

Stress Test	Stress Condition	Stress Duration
Solderability	Tsol=230°C , 5sec	1 times
Reflow	Tsol=260°C , 10sec, 6min	3 times
Thermal Shock	H : +110°C 20min. ↓ 10sec. 'L : - 40°C 20min.	500 Cycles
Temperature Cycle	H : +100°C 30min. ↓ 5min. 'L : - 40°C 30min.	1000 Cycles
High Temperature/Humidity Reverse Bias	Ta=85°C , RH=85%	1000hours
High Temperature Storage	Ta=110°C	1000hours
Low Temperature Storage	Ta=-40°C	1000hours
Intermittent operational Life	Ta=25°C , IF=1000mA 30mS on/ 2500mS off	1000hours
High Temperature Operation Life #1	Ta=55°C , IF=350mA	1000hours
High Temperature Operation Life #2	Ta=85°C , IF=225mA	1000hours
High Temperature Operation Life #3	Ta=100°C , IF=150mA	1000hours
Low Temperature Operation Life	Ta=-40°C , IF=350mA	1000hours
Power Temperature Cycle	H : +85°C 15min. ↓ 5min. 'L : - 40°C 15min. IF=225mA,2min on/off	1000cycles
ESD Human Body Model	2000V, Interval:0.5sec	3 times
ESD Machine Model	200V, Interval:0.5sec	3 times

*Im: BRIGHTNESS ATTENUATE DIFFERENCE(1000hrs)<50%

*VF: FORWARD VOLTAGE DIFFERENCE <20%

Precautions For Use

1. Over-current-proof

Though EHP-A07 has conducted ESD protection mechanism, customer must not use the device in reverse and should apply resistors for extra protection. Otherwise slight voltage shift may cause enormous current change and burn out failure would happen.

2. Storage

- i. Do not open moisture proof bag before the products are ready to use.
- ii. Before opening the package, the LEDs should be kept at 30°C or less and 90%RH or less.
- iii. The LEDs should be used within a year.
- iv. After opening the package, the LEDs should be kept at 30°C or less and 70%RH or less.
- v. The LEDs should be used within 168 hours (7 days) after opening the package.
- vi. If the moisture absorbent material (silicone gel) has faded away or the LEDs have exceeded the storage time, baking treatment should be performed using the following conditions.
- vii. Pre-curing treatment : 60±5°C for 24 hours.

3. Thermal Management

- i. Because EHP-A07 LED is a high power dissipation device, special and sufficient consideration in thermal management design must be made to optimize the thermal performance.
- ii. Heat sink design is implemented in the device for an additional thermal connection. Since the device is capable of SMT process, tin must be spread both heat sink and solder pads areas to dissipate the heat.
- iii. A high thermal conductivity substrate, such as Aluminum or Copper plate etc, must be applied for external thermal management. It is strongly recommended that the outer heat sink or PCB dimension per LED can not be less than 25 x 25 x 1 (L x W x H) mm. The materials for outer heat sink can be FR4 on Aluminum, MCPCB, or FPC on Aluminum.
- iv. Sspecial thermal designs are also recommended to take in outer heat sink design, such as FR4 PCB on Aluminum with thermal vias or FPC on Aluminum with thermal conductive adhesive, etc.
- v. Sufficient thermal management must be conducted, or the die junction temperature will be over the limit under large electronic driving and LED lifetime will decrease critically.

4. Soldering Condition

- i. Lead reflow soldering temperature profile

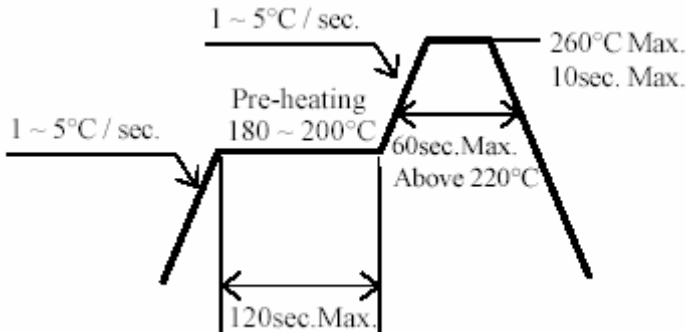

- ii. Reflow soldering should not be done more than two times.
- iii. While soldering, do not put stress on the LEDs during heating.
- iv. After soldering, do not warp the circuit board

5. Soldering Iron

- i. For prototype builds or small series production runs it is possible to place and solder the LED by hand.
- ii. Dispensing thermal conductive glue or grease on the substrates and follow its curing spec. Press LED housing to closely connect LED and substrate.
- iii. It is recommended to hand solder the leads with a solder tip temperature of 280°C for less than 3 seconds within once in less than the soldering iron capacity 25W. Leave two seconds and more intervals, and do soldering of each terminal.
- iv. Be careful because the damage of the product is often started at the time of the hand solder.

6. Handling Indications

During processing, mechanical stress on the surface should be minimized as much as possible. Sharp objects of all types should not be used to pierce the sealing compound.