

Features

- Single, dual, and quad topologies
- 3mA supply current (per amplifier)
- 250MHz -3dB bandwidth
- 1200V/μs slew rate
- Tiny package options (SOT23, LPP)
- Low cost
- Single- and dual-supply operation down to ±1.5V
- 0.05%/0.05° diff. gain/diff. phase into 150Ω

Applications

- Low power/battery applications
- HDSL amplifiers
- Video amplifiers
- Cable drivers
- RGB amplifiers
- Test equipment amplifiers
- Current to voltage converters

Ordering Information

Part No	Package	Tape & Reel	Outline #
EL2180CN	8-Pin PDIP	-	MDP0031
EL2180CS	8-Pin SO	-	MDP0027
EL2180CS-T7	8-Pin SO	7"	MDP0027
EL2180CS-T13	8-Pin SO	13"	MDP0027
EL2180CW-T7	5-Pin SOT23	7"	MDP0038
EL2180CW-T13	5-Pin SOT23	13"	MDP0038
EL2280CN	8-Pin PDIP	-	MDP0031
EL2280CS	8-Pin SO	-	MDP0027
EL2280CS-T7	8-Pin SO	7"	MDP0027
EL2280CS-T13	8-Pin SO	13"	MDP0027
EL2480CN	14-Pin PDIP	-	MDP0031
EL2480CS	14-Pin SO	-	MDP0027
EL2480CS-T7	14-Pin SO	7"	MDP0027
EL2480CS-T13	14-Pin SO	13"	MDP0027
EL2480CL	24-Pin LPP	-	MDP0046
EL2480CL-T7	24-Pin LPP	7"	MDP0046
EL2480CL-T13	24-Pin LPP	13"	MDP0046

General Description

The EL2180C/EL2280C/EL2480C are single/dual/quad current-feedback operational amplifiers that achieve a -3dB bandwidth of 250MHz at a gain of +1 while consuming only 3mA of supply current per amplifier. They will operate with dual supplies ranging from ±1.5V to ±6V or from single supplies ranging from +3V to +12V. In spite of their low supply current, the EL2480C and the EL2280C can output 55mA while swinging to ±4V on ±5V supplies. The EL2180C can output 100mA with similar output swings. These attributes make the EL2180C/EL2280C/EL2480C excellent choices for low power and/or low voltage cable driver, HDSL, or RGB applications.

For applications where board space is extremely critical, the EL2180C is available in the tiny 5-pin SOT23 package, with a footprint size 28% of an 8-pin SO. The EL2480C is also available in a 24-pin LPP package. All are specified for operation over the full -40°C to +85°C temperature range.

Single, dual, and triple versions are also available with the enable function (EL2186C, EL2286C, and EL2386C).

Connection Diagrams

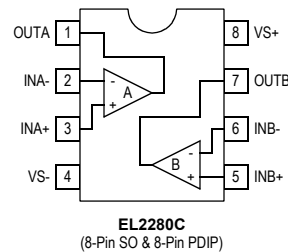
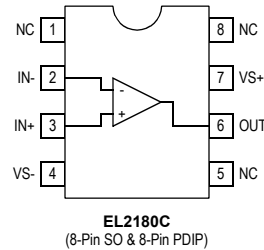

Note: All information contained in this data sheet has been carefully checked and is believed to be accurate as of the date of publication; however, this data sheet cannot be a "controlled document". Current revisions, if any, to these specifications are maintained at the factory and are available upon your request. We recommend checking the revision level before finalization of your design documentation.

EL2180C/EL2280C/EL2480C-Preliminary

250MHz / 3mA Current Mode Feedback Amplifiers

Absolute Maximum Ratings (T_A = 25°C)

Supply Voltage between V _{S+} and GND	+12.6V	Operating Junction Temperature	
Voltage between V _{S+} and V _{S-}	+12.6V	Plastic Packages	150°C
Common-Mode Input Voltage	V _{S-} to V _{S+}	Output Current (EL2180C)	±120mA
Differential Input Voltage	±6V	Output Current (EL2280C)	±60mA
Current into +IN or -IN	±7.5mA	Output Current (EL2480C)	±60mA
Internal Power Dissipation	See Curves	Storage Temperature Range	-65°C to +150°C
Operating Ambient Temperature Range	-40°C to +85°C		

Important Note:

All parameters having Min/Max specifications are guaranteed. Typ values are for information purposes only. Unless otherwise noted, all tests are at the specified temperature and are pulsed tests, therefore: T_J = T_C = T_A.

DC Electrical Characteristics

V_S = ±5V, R_L = 150Ω, T_A = 25°C unless otherwise specified.

Parameter	Description	Conditions	Min	Typ	Max	Unit
V _{OS}	Input Offset Voltage			2.5	10	mV
TCV _{OS}	Average Input Offset Voltage Drift	Measured from T _{MIN} to T _{MAX}		5		μV/°C
dV _{OS}	V _{OS} Matching	EL2280C, EL2480C only		0.5		mV
+I _{IN}	+Input Current			1.5	15	μA
d+I _{IN}	+I _{IN} Matching	EL2280C, EL2480C only		20		nA
-I _{IN}	-Input Current			16	40	μA
d-I _{IN}	-I _{IN} Matching	EL2280C, EL2480C only		2		μA
CMRR	Common Mode Rejection Ratio	V _{CM} = ±3.5V	45	50		dB
-ICMR	-Input Current Common Mode Rejection	V _{CM} = ±3.5V		5	30	μA/V
PSRR	Power Supply Rejection Ratio	V _S is moved from ±4V to ±6V	60	70		dB
-IPSR	-Input Current Power Supply Rejection	V _S is moved from ±4V to ±6V		1	15	μA/V
R _{OL}	Transimpedance	V _{OUT} = ±2.5V	120	300		kΩ
+R _{IN}	+Input Resistance	V _{CM} = ±3.5V	0.5	2		MΩ
+C _{IN}	+Input Capacitance			1.2		pF
CMIR	Common Mode Input Range		±3.5	±4.0		V
V _O	Output Voltage Swing	V _S = ±5	±3.5	±4.0		V
		V _S = +5 Single-supply, high		4.0		V
		V _S = +5 Single-supply, low		0.3		V
I _O	Output Current	EL2180C only	80	100		mA
		EL2280C only, per amplifier	50	55		mA
		EL2480C only, per amplifier	50	55		mA
I _S	Supply Current	Per amplifier		3	6	mA

AC Electrical Characteristics

V_S = ±5V, R_F = R_G = 750Ω for PDIP and SO packages, R_F = R_G = 560Ω for SOT23-5 package, R_L = 150Ω, T_A = 25°C unless otherwise specified

Parameter	Description	Conditions	Min	Typ	Max	Unit
-3dB BW	-3dB Bandwidth	A _V = +1		250		MHz
-3dB BW	-3dB Bandwidth	A _V = +2		180		MHz
0.1dB BW	0.1dB Bandwidth	A _V = +2		50		MHz
SR	Slew Rate	V _{OUT} = ±2.5V, A _V = +2	600	1200		V/μs
t _R , t _F	Rise and Fall Time	V _{OUT} = ±500 mV		1.5		ns

EL2180C/EL2280C/EL2480C-Preliminary

250MHz / 3mA Current Mode Feedback Amplifiers

EL2180C/EL2280C/EL2480C-Preliminary

AC Electrical Characteristics

$V_S = \pm 5V$, $R_F = R_G = 750\Omega$ for PDIP and SO packages, $R_F = R_G = 560\Omega$ for SOT23-5 package, $R_L = 150\Omega$, $T_A = 25^\circ C$ unless otherwise specified

Parameter	Description	Conditions	Min	Typ	Max	Unit
t _{PD}	Propagation Delay	V _{OUT} = ±500 mV		1.5		ns
OS	Overshoot	V _{OUT} = ±500 mV		3.0		%
t _s	0.1% Settling	V _{OUT} = ±2.5V, A _V = -1		15		ns
dG	Differential Gain	A _V = +2, R _L = 150Ω ^[1]		0.05		%
dP	Differential Phase	A _V = +2, R _L = 150Ω ^[1]		0.05		°
dG	Differential Gain	A _V = +1, R _L = 500Ω ^[1]		0.01		%
dP	Differential Phase	A _V = +1, R _L = 500Ω ^[1]		0.01		°
C _S	Channel Separation	EL2280C, EL2480C only, f = 5 MHz		85		dB

1. DC offset from 0V to 0.714V, AC amplitude 286mV_{P-P}, f = 3.58MHz

Connection Diagrams (Continued)

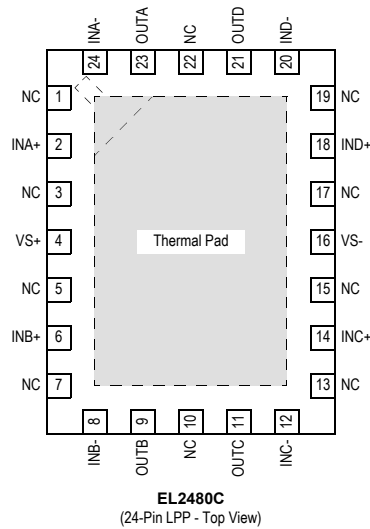
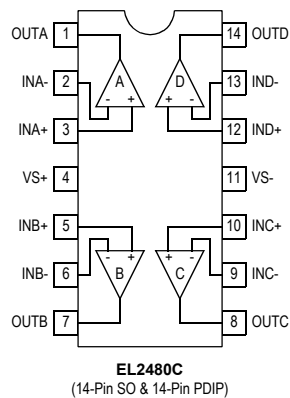
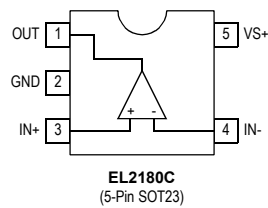

EL2180C/EL2280C/EL2480C-Preliminary

250MHz / 3mA Current Mode Feedback Amplifiers

Test Circuit (Per Amplifier)

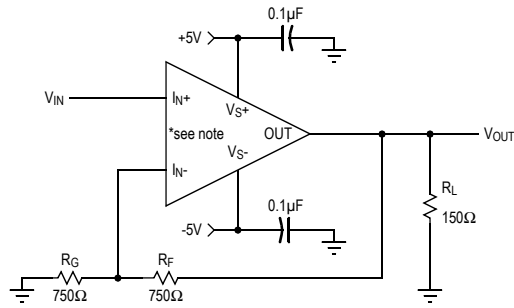

* Note: EL2180C or
 1/2 EL2280C or
 1/4 EL2480C

Simplified Schematic (Per Amplifier)

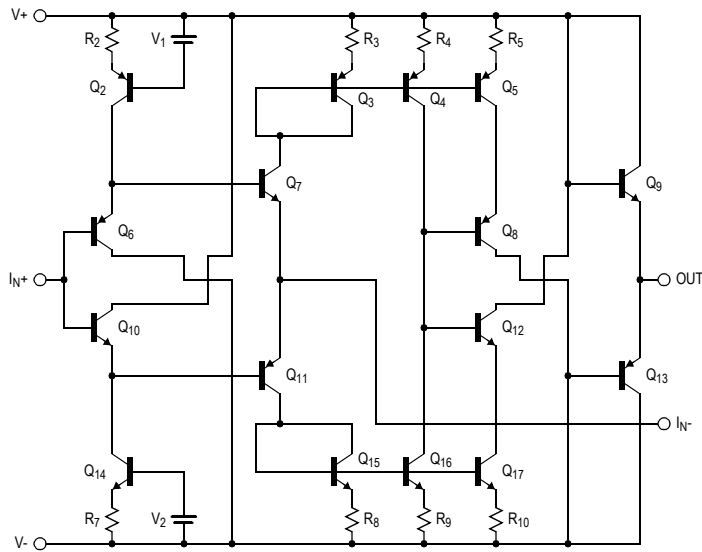

EL2180C/EL2280C/EL2480C-Preliminary

250MHz / 3mA Current Mode Feedback Amplifiers

EL2180C/EL2280C/EL2480C-Preliminary

Typical Performance Curves

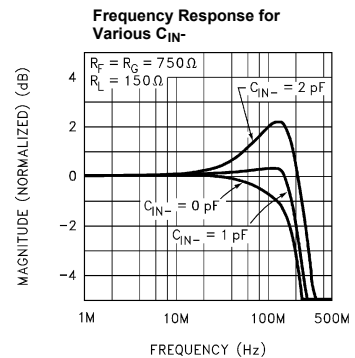
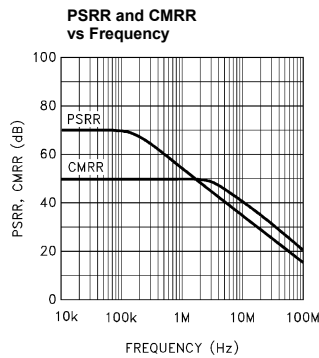
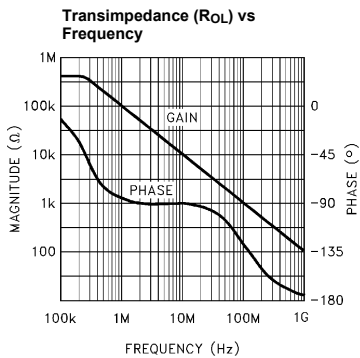
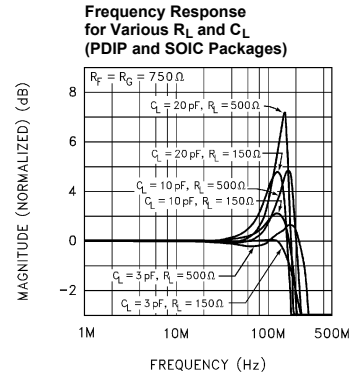
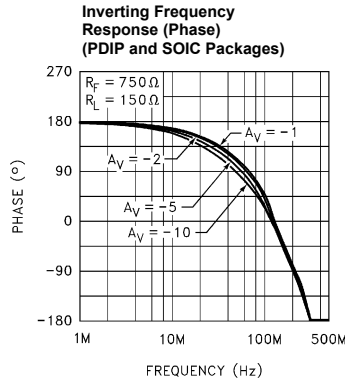
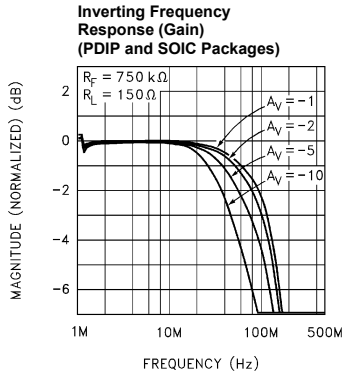
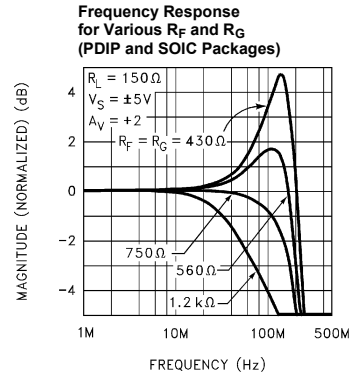
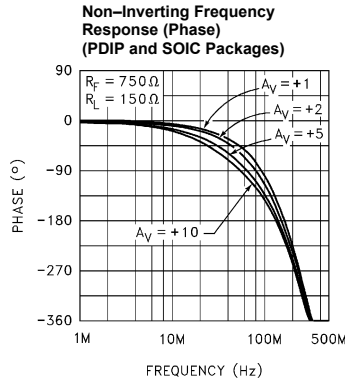
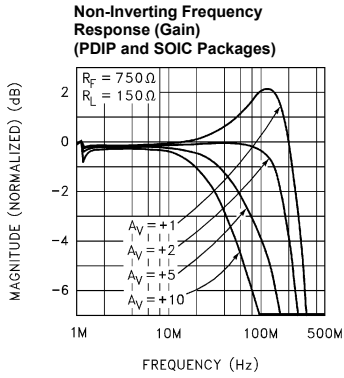

EL2180C/EL2280C/EL2480C-Preliminary

250MHz / 3mA Current Mode Feedback Amplifiers

Typical Performance Curves

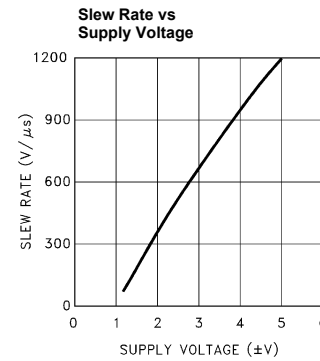
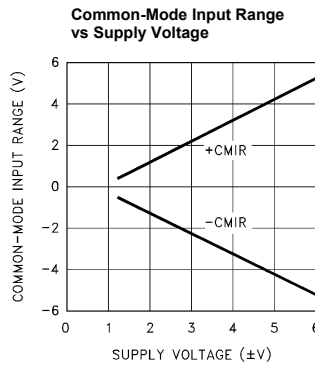
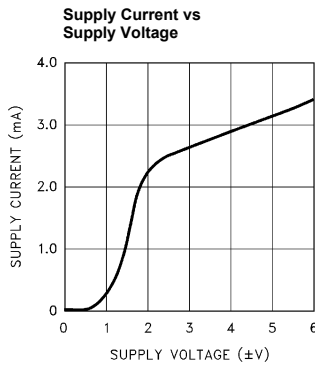
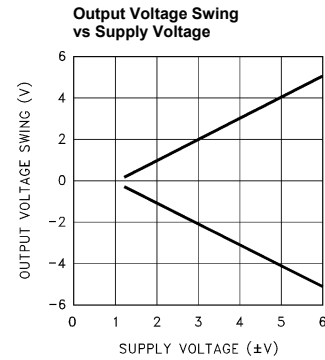
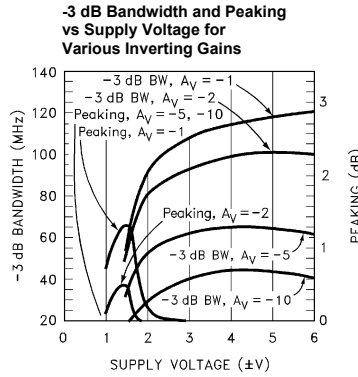
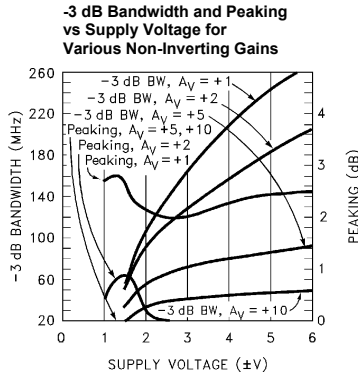
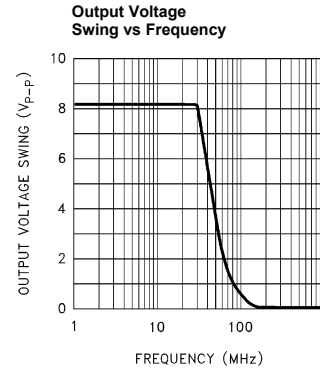
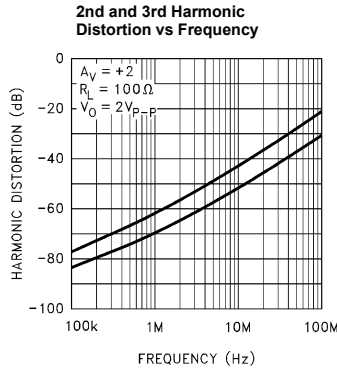
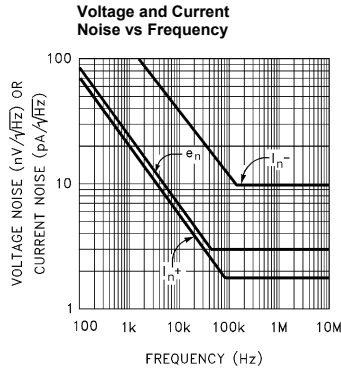

EL2180C/EL2280C/EL2480C-Preliminary

250MHz / 3mA Current Mode Feedback Amplifiers

EL2180C/EL2280C/EL2480C-Preliminary

Typical Performance Curves

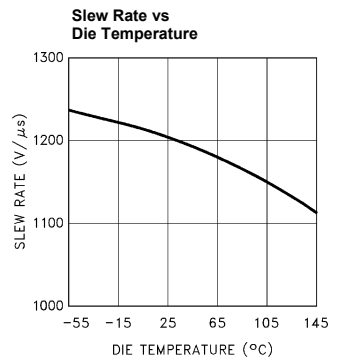
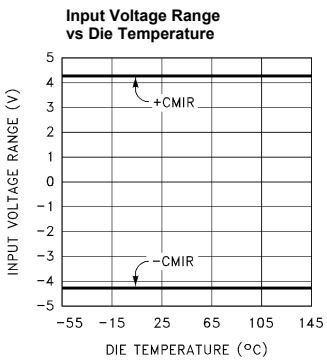
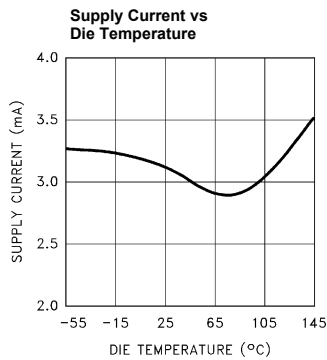
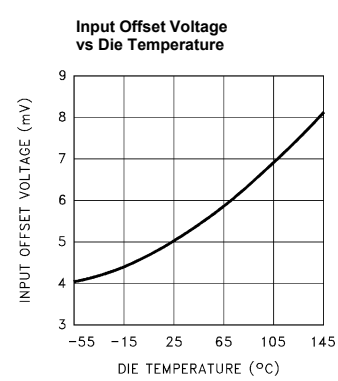
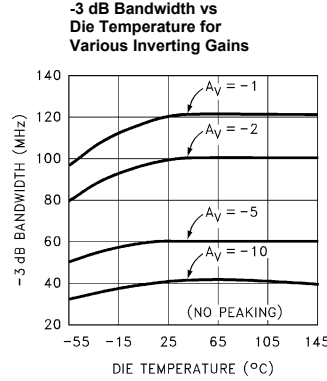
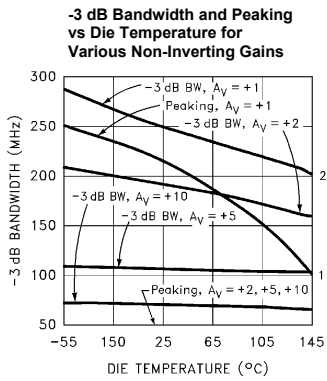
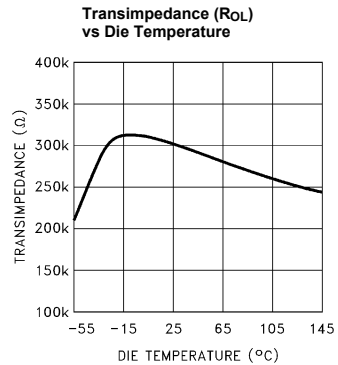
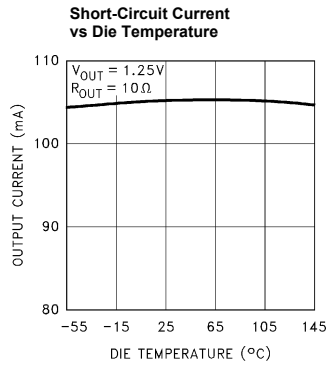
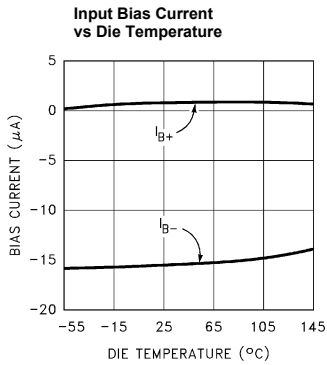

EL2180C/EL2280C/EL2480C-Preliminary

250MHz / 3mA Current Mode Feedback Amplifiers

Typical Performance Curves

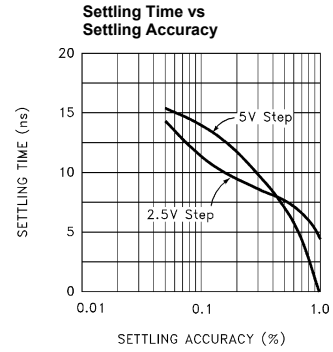
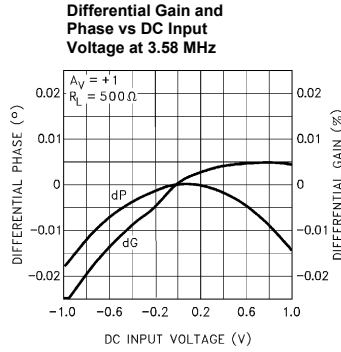
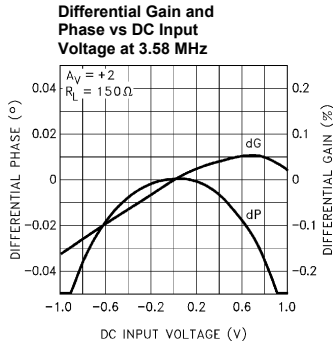

Small-Signal Step Response

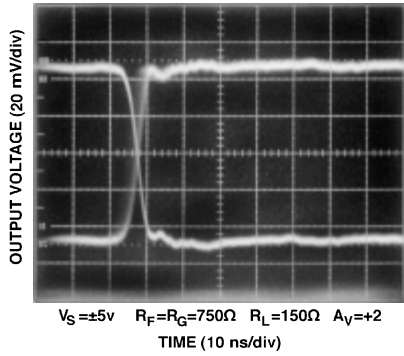

Large-Signal Step Response

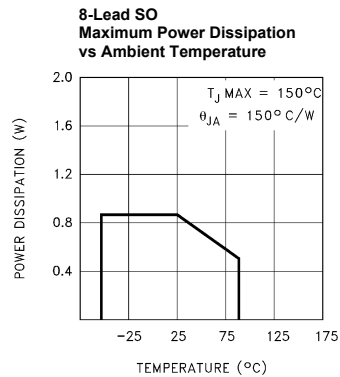
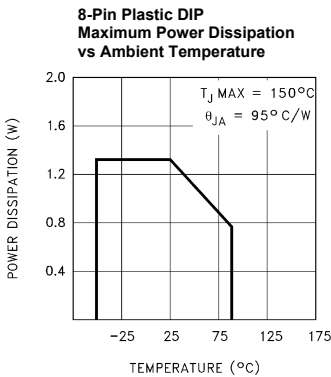
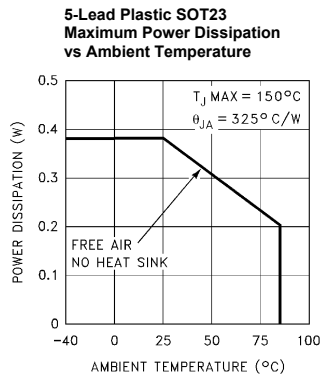
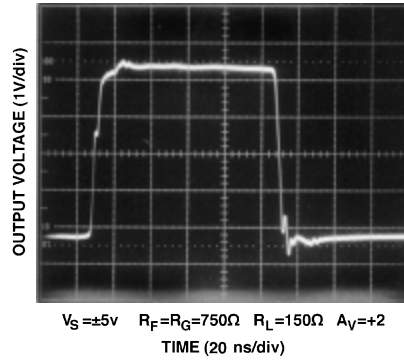

EL2180C/EL2280C/EL2480C-Preliminary

250MHz / 3mA Current Mode Feedback Amplifiers

EL2180C/EL2280C/EL2480C-Preliminary

Typical Performance Curves

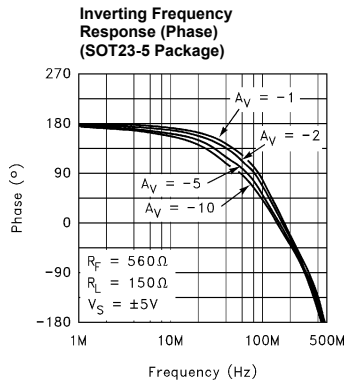
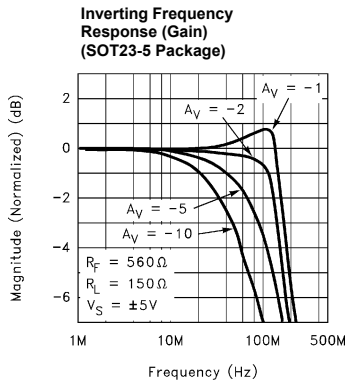
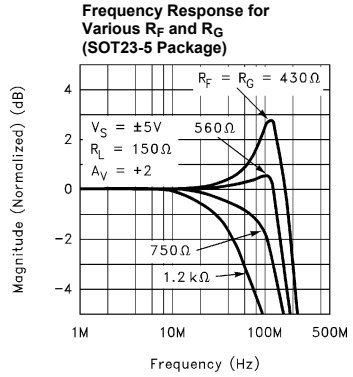
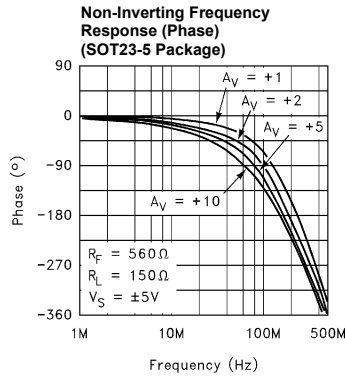
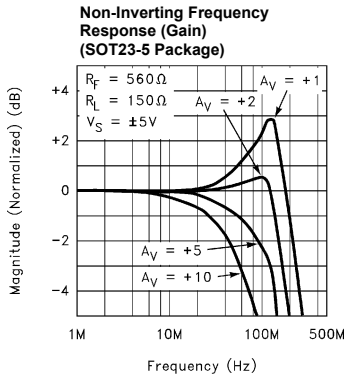
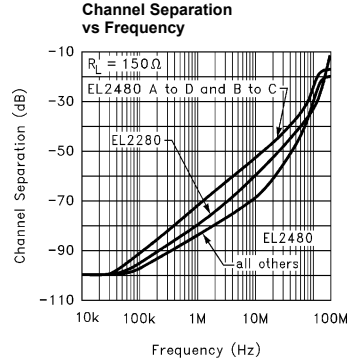
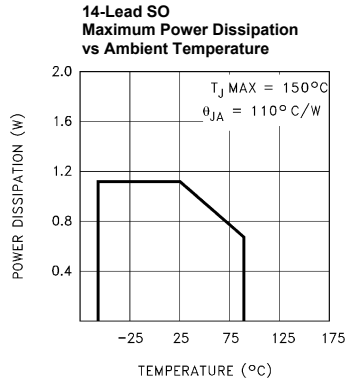
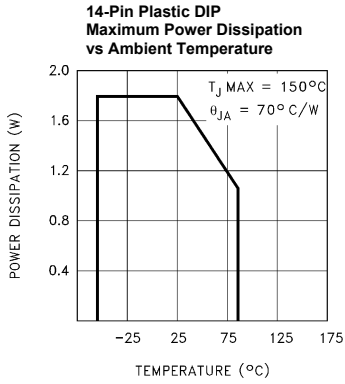

EL2180C/EL2280C/EL2480C-Preliminary

250MHz / 3mA Current Mode Feedback Amplifiers

Applications Information

Product Description

The EL2180C/EL2280C/EL2480C are current-feedback operational amplifiers that offer a wide -3dB bandwidth of 250MHz and a low supply current of 3mA per amplifier. All of these products also feature high output current drive. The EL2180C can output 100mA, while the EL2280C and the EL2480C can output 55mA per amplifier. The EL2180C/EL2280C/EL2480C work with supply voltages ranging from a single 3V to $\pm 6V$ and they are also capable of swinging to within 1V of either supply on the input and the output. Because of their current-feedback topology, the EL2180C/EL2280C/EL2480C do not have the normal gain-bandwidth product associated with voltage-feedback operational amplifiers. This allows their -3dB bandwidth to remain relatively constant as closed-loop gain is increased. This combination of high bandwidth and low power, together with aggressive pricing make the EL2180C/EL2280C/EL2480C the ideal choice for many low-power/high-bandwidth applications such as portable computing, HDSL, and video processing.

For applications where board space is extremely critical, the EL2180C is available in the tiny 5-pin SOT23 package, which has a footprint 28% the size of an 8-pin SO. The EL2480C is available in the 24-pin LPP package, offering board space savings and better power dissipation compared to the SO and PDIP packages. The EL2180C/EL2280C/EL2480C are each also available in industry-standard pinouts in PDIP and SO packages.

For single, dual, and triple applications with disable, consider the EL2186C (8-pin single), EL2286C (14-pin dual), and EL2386C (16-pin triple). If lower power is required, refer to the EL2170C/EL2176C family which provides singles, duals, and quads with 70MHz of bandwidth while consuming 1mA of supply current per amplifier.

Power Supply Bypassing and Printed Circuit Board Layout

As with any high-frequency device, good printed circuit board layout is necessary for optimum performance. Ground plane construction is highly recommended. Lead lengths should be as short as possible. The power

supply pins must be well bypassed to reduce the risk of oscillation. The combination of a 4.7 μ F tantalum capacitor in parallel with a 0.1 μ F capacitor has been shown to work well when placed at each supply pin.

For good AC performance, parasitic capacitance should be kept to a minimum especially at the inverting input (see the Capacitance at the Inverting Input section). Ground plane construction should be used, but it should be removed from the area near the inverting input to minimize any stray capacitance at that node. Carbon or Metal-Film resistors are acceptable with the Metal-Film resistors giving slightly less peaking and bandwidth because of their additional series inductance. Use of sockets, particularly for the SO package, should be avoided if possible. Sockets add parasitic inductance and capacitance which will result in some additional peaking and overshoot.

Capacitance at the Inverting Input

Any manufacturer's high-speed voltage- or current-feedback amplifier can be affected by stray capacitance at the inverting input. For inverting gains this parasitic capacitance has little effect because the inverting input is a virtual ground, but for non-inverting gains this capacitance (in conjunction with the feedback and gain resistors) creates a pole in the feedback path of the amplifier. This pole, if low enough in frequency, has the same destabilizing effect as a zero in the forward open-loop response. The use of large value feedback and gain resistors further exacerbates the problem by further lowering the pole frequency.

The experienced user with a large amount of PC board layout experience may find in rare cases that the EL2180C/EL2280C/EL2480C have less bandwidth than expected.

The reduction of feedback resistor values (or the addition of a very small amount of external capacitance at the inverting input, e.g. 0.5pF) will increase bandwidth as desired. Please see the curves for Frequency Response for Various R_F and R_G , and Frequency Response for Various C_{IN} .

EL2180C/EL2280C/EL2480C-Preliminary

250MHz / 3mA Current Mode Feedback Amplifiers

EL2180C/EL2280C/EL2480C-Preliminary

Feedback Resistor Values

The EL2180C/EL2280C/EL2480C have been designed and specified at gains of +1 and +2 with $R_F = 750\Omega$ in PDIP and SO packages and $R_F = 560\Omega$ in 5-pin SOT23 package. These values of feedback resistors give 250MHz of -3dB bandwidth at $A_V = +1$ with about 2.5dB of peaking, and 180MHz of -3dB bandwidth at $A_V = +2$ with about 0.1dB of peaking. The 5-pin SOT23 package is characterized with a smaller value of feedback resistor, for a given bandwidth, to compensate for lower parasitics within both the package itself and the printed circuit board where it will be placed. Since the EL2180C/EL2280C/EL2480C are current-feedback amplifiers, it is also possible to change the value of R_F to get more bandwidth. As seen in the curve of Frequency Response For Various R_F and R_G , bandwidth and peaking can be easily modified by varying the value of the feedback resistor.

Because the EL2180C/EL2280C/EL2480C are current-feedback amplifiers, their gain-bandwidth product is not a constant for different closed-loop gains. This feature actually allows the EL2180C/EL2280C/EL2480C to maintain about the same -3dB bandwidth, regardless of closed-loop gain. However, as closed-loop gain is increased, bandwidth decreases slightly while stability increases. Since the loop stability is improving with higher closed-loop gains, it becomes possible to reduce the value of R_F below the specified 560 Ω and 750 Ω and still retain stability, resulting in only a slight loss of bandwidth with increased closed-loop gain.

Supply Voltage Range and Single-Supply Operation

The EL2180C/EL2280C/EL2480C have been designed to operate with supply voltages having a span of greater than 3V, and less than 12V. In practical terms, this means that the EL2180C/EL2280C/EL2480C will operate on dual supplies ranging from $\pm 1.5V$ to $\pm 6V$. With a single-supply, the EL2180C/EL2280C/EL2480C will operate from +3V to +12V.

As supply voltages continue to decrease, it becomes necessary to provide input and output voltage ranges that can get as close as possible to the supply voltages. The EL2180C/EL2280C/EL2480C have an input voltage range that extends to within 1V of either supply. So, for

example, on a single +5V supply, the EL2180C/EL2280C/EL2480C have an input range which spans from 1V to 4V. The output range of the EL2180C/EL2280C/EL2480C is also quite large, extending to within 1V of the supply rail. On a $\pm 5V$ supply, the output is therefore capable of swinging from -4V to +4V. Single-supply output range is even larger because of the increased negative swing due to the external pull-down resistor to ground. On a single +5V supply, output voltage range is about 0.3V to 4V.

Video Performance

For good video performance, an amplifier is required to maintain the same output impedance and the same frequency response as DC levels are changed at the output. This is especially difficult when driving a standard video load of 150 Ω , because of the change in output current with DC level. Until the EL2180C/EL2280C/EL2480C, good Differential Gain could only be achieved by running high idle currents through the output transistors (to reduce variations in output impedance). These currents were typically comparable to the entire 3mA supply current of each EL2180C/EL2280C/EL2480C amplifier! Special circuitry has been incorporated in the EL2180C/EL2280C/EL2480C to reduce the variation of output impedance with current output. This results in dG and dP specifications of 0.05% and 0.05 $^\circ$ while driving 150 Ω at a gain of +2.

Video Performance has also been measured with a 500 Ω load at a gain of +1. Under these conditions, the EL2180C/EL2280C/EL2480C have dG and dP specifications of 0.01% and 0.01 $^\circ$ respectively while driving 500 Ω at $A_V = +1$.

Output Drive Capability

In spite of its low 3mA of supply current, the EL2180C is capable of providing a minimum of $\pm 80mA$ of output current. Similarly, each amplifier of the EL2280C and the EL2480C is capable of providing a minimum of $\pm 50mA$. These output drive levels are unprecedented in amplifiers running at these supply currents. With a minimum $\pm 80mA$ of output drive, the EL2180C is capable of driving 50 Ω loads to $\pm 4V$, making it an excellent choice for driving isolation transformers in telecommunications applications. Similarly, the $\pm 50mA$ minimum

EL2180C/EL2280C/EL2480C-Preliminary

250MHz / 3mA Current Mode Feedback Amplifiers

output drive of each EL2280C and EL2480C amplifier allows swings of $\pm 2.5V$ into 50Ω loads.

Driving Cables and Capacitive Loads

When used as a cable driver, double termination is always recommended for reflection-free performance. For those applications, the back-termination series resistor will decouple the EL2180C/EL2280C/EL2480C from the cable and allow extensive capacitive drive. However, other applications may have high capacitive loads without a back-termination resistor. In these applications, a small series resistor (usually between 5Ω and 50Ω) can be placed in series with the output to eliminate most peaking. The gain resistor (R_G) can then be chosen to make up for any gain loss which may be created by this additional resistor at the output. In many cases it is also possible to simply increase the value of the feedback resistor (R_F) to reduce the peaking.

Current Limiting

The EL2180C/EL2280C/EL2480C have no internal current-limiting circuitry. If any output is shorted, it is possible to exceed the Absolute Maximum Ratings for output current or power dissipation, potentially resulting in the destruction of the device.

Power Dissipation

With the high output drive capability of the EL2180C/EL2280C/EL2480C, it is possible to exceed the $150^\circ C$ Absolute Maximum junction temperature under certain very high load current conditions. Generally speaking, when R_L falls below about 25Ω , it is important to calculate the maximum junction temperature (T_{JMAX}) for the application to determine if power-supply voltages, load conditions, or package type need to be modified for the EL2180C/EL2280C/EL2480C to remain in the safe operating area. These parameters are calculated as follows:

$$T_{JMAX} = T_{MAX} + (\theta_{JA} \times n \times PD_{MAX})$$

where:

T_{MAX} = Maximum Ambient Temperature

θ_{JA} = Thermal Resistance of the Package

n = Number of Amplifiers in the Package

PD_{MAX} = Maximum Power Dissipation of Each Amplifier in the Package

PD_{MAX} for each amplifier can be calculated as follows:

$$PD_{MAX} = (2 \times V_S \times I_{SMAX}) + (V_S - V_{OUTMAX}) \times \frac{V_{OUTMAX}}{R_L}$$

where:

V_S = Supply Voltage

I_{SMAX} = Maximum Supply Current of 1 Amplifier

V_{OUTMAX} = Maximum Output Voltage of the Application

R_L = Load Resistance

EL2180C/EL2280C/EL2480C-Preliminary

250MHz / 3mA Current Mode Feedback Amplifiers

EL2180C/EL2280C/EL2480C-Preliminary

Typical Application Circuits

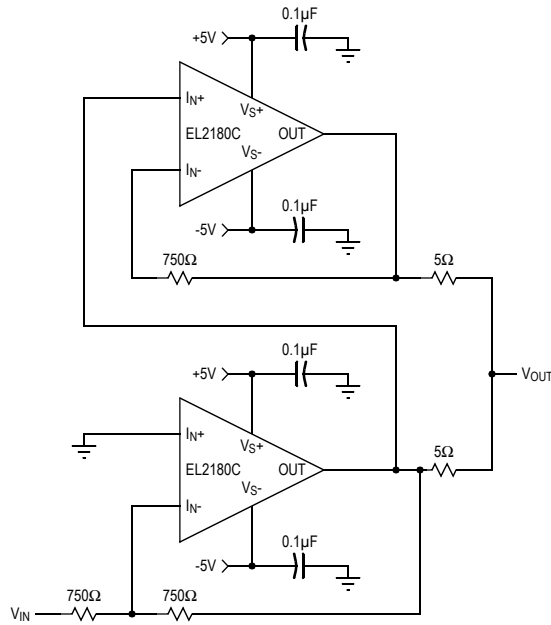
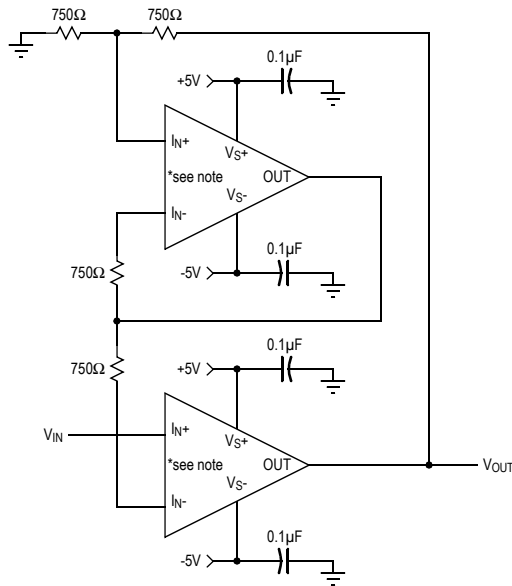

Figure 1. Inverting 200mA Output Current Distribution Amplifier



* Note: $\frac{1}{2}$ EL2280C or $\frac{1}{2}$ EL2480C

Figure 2. Fast-Settling Precision Amplifier

EL2180C/EL2280C/EL2480C-Preliminary
 250MHz / 3mA Current Mode Feedback Amplifiers

Typical Application Circuits (Continued)

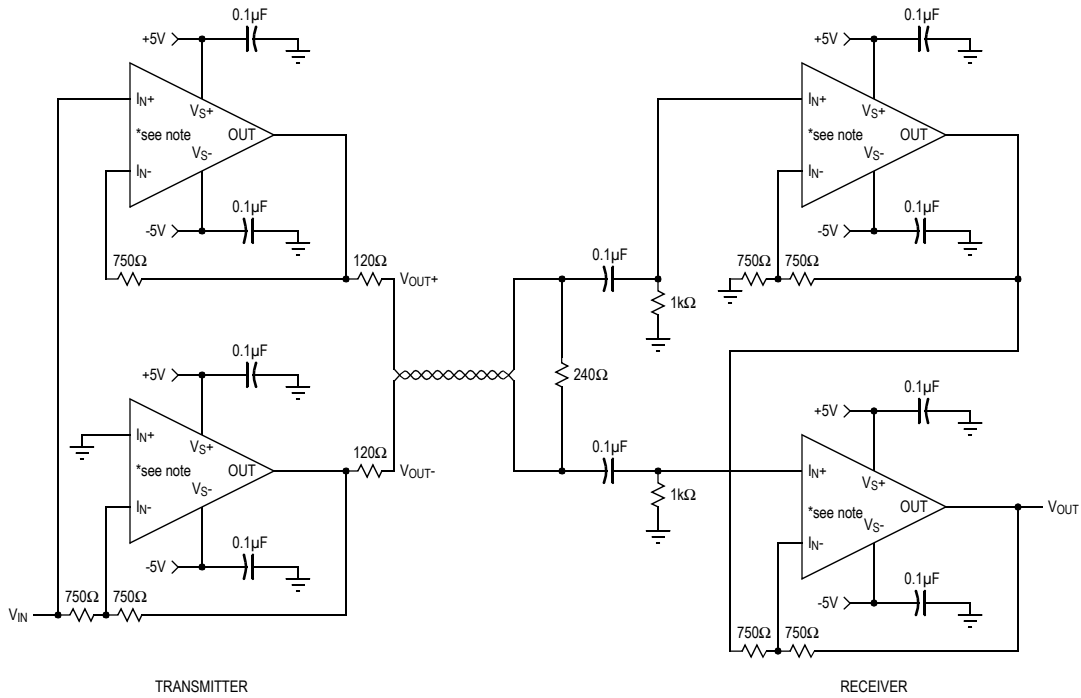

* Note: EL2180 or
 1/2 EL2280C or
 1/4 EL2480C

Figure 3. Differential Line Driver/Receiver

EL2180C/EL2280C/EL2480C-Preliminary

250MHz / 3mA Current Mode Feedback Amplifiers

EL2180C/EL2280C/EL2480C-Preliminary

EL2180C/EL2280C/EL2480C Macromodel

```
* EL2180 Macromodel
* Revision A, March 1995
* AC characteristics used: Rf = Rg = 750 ohms
* Connections:  +input
*              -input
*              +Vsupply
*              -Vsupply
*              output
*
.subckt EL2180/el 3 2 7 4 6
*
* Input Stage
*
e1 10 3 0 1.0
vis 10 9 0V
h2 9 12 vxx 1.0
r1 2 11 400
l1 11 12 25nH
iinp 3 0 1.5uA
iinm 2 0 3uA
r12 3 0 2Meg
*
* Slew Rate Limiting
*
h1 13 0 vis 600
r2 13 14 1K
d1 14 0 dclamp
d2 0 14 dclamp
*
* High Frequency Pole
*
e2 30 0 14 0 0.001666666666
l3 30 17 150nH
c5 17 0 0.8pF
r5 17 0 165
*
* Transimpedance Stage
*
g1 0 18 17 0 1.0
rol 18 0 450K
cdp 18 0 0.675pF
*
* Output Stage
*
q1 4 18 19 qp
q2 7 18 20 qn
q3 7 19 21 qn
q4 4 20 22 qp
r7 21 6 4
r8 22 6 4
ios1 7 19 1mA
ios2 20 4 1mA
*
* Supply Current
*
ips 7 4 0.2mA
*
* Error Terms
*
ivos 0 23 0.2mA
vxx 23 0 0V
e4 24 0 3 0 1.0
```

EL2180C/EL2280C/EL2480C-Preliminary

250MHz / 3mA Current Mode Feedback Amplifiers

```

e5 25 0 7 0 1.0
e6 26 0 4 0 -1.0
r9 24 23 316
r10 25 23 3.2K
r11 26 23 3.2K
*
* Models
*
.model qn npn(is=5e-15 bf=200 tf=0.01nS)
*.model qp pnp(is=5e-15 bf=200 tf=0.01nS)
.model dclamp d(is=1e-30 ibv=0.266
+ bv=0.71v n=4)
.ends
    
```

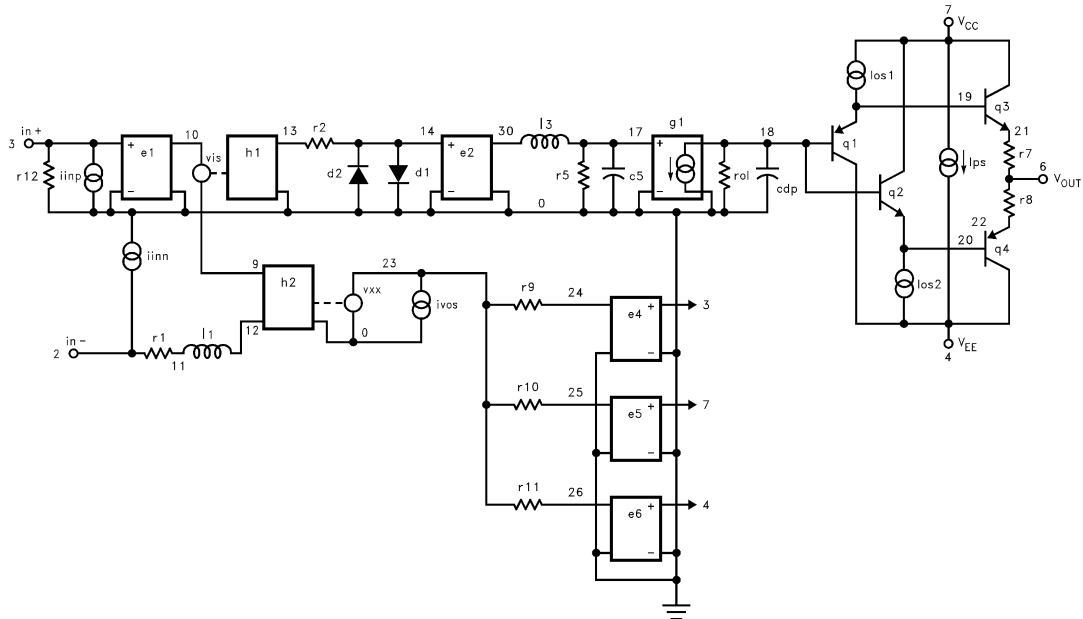

EL2180C/EL2280C/EL2480C-Preliminary

250MHz / 3mA Current Mode Feedback Amplifiers

General Disclaimer

Specifications contained in this data sheet are in effect as of the publication date shown. Elantec, Inc. reserves the right to make changes in the circuitry or specifications contained herein at any time without notice. Elantec, Inc. assumes no responsibility for the use of any circuits described herein and makes no representations that they are free from patent infringement.

élantec

HIGH PERFORMANCE ANALOG INTEGRATED CIRCUITS

Elantec Semiconductor, Inc.

675 Trade Zone Blvd.

Milpitas, CA 95035

Telephone: (408) 945-1323

(888) ELANTEC

Fax: (408) 945-9305

European Office: +44-118-977-6020

Japan Technical Center: +81-45-682-5820

WARNING - Life Support Policy

Elantec, Inc. products are not authorized for and should not be used within Life Support Systems without the specific written consent of Elantec, Inc. Life Support systems are equipment intended to support or sustain life and whose failure to perform when properly used in accordance with instructions provided can be reasonably expected to result in significant personal injury or death. Users contemplating application of Elantec, Inc. Products in Life Support Systems are requested to contact Elantec, Inc. factory headquarters to establish suitable terms & conditions for these applications. Elantec, Inc.'s warranty is limited to replacement of defective components and does not cover injury to persons or property or other consequential damages.