

**Features**

- Unity gain stable
- Wide bandwidth—60 MHz
- High slew rate—200 V/ $\mu$ s
- High power bandwidth ( $\pm 10 V_{out}$ ) 3 MHz
- Large open loop gain 75 dB
- Low power—5 mA/amplifier
- Low input offset—1 mV typ.
- Wide supply voltage range  $V_s = \pm 5V$  to  $\pm 15V$
- Output short circuit protected

**Applications**

- High performance active filters
- Video and pulse amplifiers
- Local area networks
- Wideband amplifiers

**Ordering Information**

Part No.	Temp. Range	Package	Outline #
EL2224CJ	0°C to +75°C	CerDIP	MDP0010
EL2224CN	0°C to +75°C	P-DIP	MDP0031
EL2224J	-55°C to +125°C	CerDIP	MDP0010
EL2224J/883B	-55°C to +125°C	CerDIP	MDP0010
EL2224L/883B	-55°C to +125°C	LCC	MDP0007
EL2224CM	0°C to +75°C	SOL	MDP0027

**General Description**

The EL2224 monolithic dual operational amplifier is an extension of Elantec's position in high speed analog products. This amplifier features unity gain stability, high slew rate and wide bandwidth, along with an excellent speed power relationship. The dual 60 MHz EL2224 consumes only 10 mA, making it ideal for video applications. The EL2224 has short circuit protected outputs and will operate from  $\pm 5V$  to  $\pm 15V$ . It is fabricated using Elantec's Complementary Bipolar process which allows both fast PNP and NPN transistors to be manufactured on a single chip.

Elantec's products and facilities comply with MIL-STD-883 Revision C, MIL-I-45208A, and other applicable quality specifications. For information on Elantec's military processing, see Elantec document, QRA-2: "Elantec's Military Processing, Monolithic Integrated Circuits".

**Connection Diagrams**

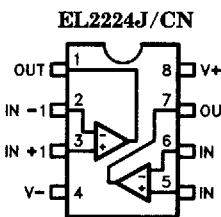

2224-1

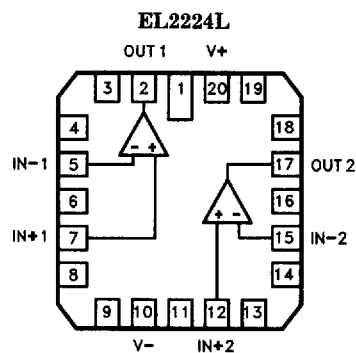

2224-2

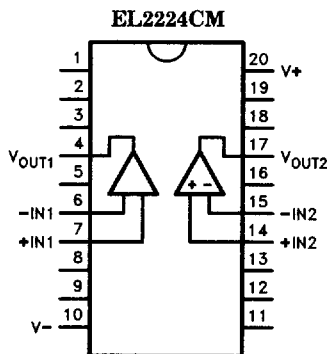

2224-3

This product covered under U.S. Patent No. 4,837,523

**EL2224/EL2224C**

ELANTEC INC

**Dual, 60 MHz, Unity Gain Stable, Operational Amplifier****Absolute Maximum Ratings** ( $T_A = 25^\circ\text{C}$ )

Voltage Between V+ and V-	35V	Operational Temperature Range	
Differential Input Voltage	$\pm 6\text{V}$	EL2224	$-55^\circ\text{C}$ to $+125^\circ\text{C}$
Internal Power Dissipation	See Curves	EL2224C	$0^\circ\text{C}$ to $+75^\circ\text{C}$
Peak Output Current	Short Circuit Protected	Storage Temperature Range	$-65^\circ\text{C}$ to $+150^\circ\text{C}$
Output Short Circuit Duration (Note 1)	Continuous	Maximum Junction Temperature	
		CerDIP, LCC	$175^\circ\text{C}$
		Plastic DIP, SOL	$150^\circ\text{C}$
		Lead Temperature	
		DIP Package	$300^\circ\text{C}$
		SOL Package	
		Vapor Phase (60 seconds)	$215^\circ\text{C}$
		Infrared (15 seconds)	$220^\circ\text{C}$

**Important Note:**

All parameters having Min/Max specifications are guaranteed. The Test Level column indicates the specific device testing actually performed during production and Quality inspection. Elantec performs most electrical tests using modern high-speed automatic test equipment, specifically the LTX77 Series system. Unless otherwise noted, all tests are pulsed tests, therefore  $T_J = T_C = T_A$ .

Test Level	Test Procedure
I	100% production tested and QA sample tested per QA test plan QCX0002.
II	100% production tested at $T_A = 25^\circ\text{C}$ and QA sample tested at $T_A = 25^\circ\text{C}$ , $T_{MAX}$ and $T_{MIN}$ per QA test plan QCX0002.
III	QA sample tested per QA test plan QCX0002.
IV	Parameter is guaranteed (but not tested) by Design and Characterization Data.
V	Parameter is typical value at $T_A = 25^\circ\text{C}$ for information purposes only.

**DC Electrical Characteristics**  $V_S = \pm 15\text{V}$ ;  $R_L = 2\text{ k}\Omega$ , unless otherwise specified

Parameter	Description	EL2224					EL2224C				Units
		Temp	Min	Typ	Max	Test Level	Min	Typ	Max	Test Level	
$V_{OS}$	Offset Voltage	$+25^\circ\text{C}$		0.5	5	I		0.5	5	I	mV
		Full			8	I			8	III	mV
$TCV_{OS}$	Average Offset Voltage Drift	Full		20		V		20		V	$\mu\text{V}/^\circ\text{C}$
$I_B$	Bias Current	$+25^\circ\text{C}$		1.5	4	I		1.5	4	I	$\mu\text{A}$
		Full			6	I			6	III	$\mu\text{A}$
$I_{OS}$	Offset Current	$+25^\circ\text{C}$		0.2	2	I		0.2	2	I	$\mu\text{A}$
		Full			3	I			3	III	$\mu\text{A}$
$R_{IN}$	Input Resistance	$+25^\circ\text{C}$		40		V		40		V	k $\Omega$
$C_{IN}$	Input Capacitance	$+25^\circ\text{C}$		1		V		1		V	pF
$V_{CM}$	Common Mode Input Range	Full	$\pm 10$	$\pm 12$		I	$\pm 10$	$\pm 12$		II	V
$e_{IN}$	Input Noise Voltage ( $f = 1\text{ kHz}$ , $R_G = 0\Omega$ )	$+25^\circ\text{C}$		15		V		15		V	$\text{nV}/\sqrt{\text{Hz}}$
$A_{VOL}$	Large Signal Voltage Gain (Notes 2, 3)	$+25^\circ\text{C}$	4k	6k		I	4k	6k		I	V/V
		Full	2.5k				2.5k			III	V/V

ELANTEC INC

**EL2224/EL2224C****Dual, 60 MHz, Unity Gain Stable, Operational Amplifier**

EI 2224 / EI 2224C

**DC Electrical Characteristics**  $V_S = \pm 15V$ ;  $R_L = 2 k\Omega$ , unless otherwise specified — Contd.

Parameter	Description	EL2224					EL2224C				Units
		Temp	Min	Typ	Max	Test Level	Min	Typ	Max	Test Level	
CMRR	Common-Mode Rejection Ratio (Note 4)	Full	70	80		I	60	80		II	dB
$V_O$	Output Voltage Swing	Full	$\pm 11$	$\pm 12.5$		I	$\pm 11$	$\pm 12.5$		II	V
$I_{SC}$	Short Circuit Current	25°C		$\pm 50$	$\pm 70$	I		$\pm 50$	$\pm 70$	I	mA
$R_O$	Output Resistance	25°C		40		V		40		V	$\Omega$
$I_s$	Supply Current	Full		9.5	13	I		9.5	13	II	mA
PSRR	Power Supply Rejection Ratio (Note 5)	Full	60	75		I	60	75		II	dB

**AC Electrical Characteristics**  $V_S = \pm 15V$ ;  $R_L = 2 k\Omega$ , unless otherwise specified

Parameter	Description	EL2224					EL2224C				Units
		Temp	Min	Typ	Max	Test Level	Min	Typ	Max	Test Level	
$f_u$	Open Loop Unity Bandwidth (Note 6)	25°C		60		V		60		V	MHz
FPBW	Full Power Bandwidth (Notes 2, 7)	25°C	2.4	3.1		I	2.4	3.1		I	MHz
$t_r$	Rise Time (Note 8)	25°C		6		V		6		V	ns
OS	Overshoot (Note 8)	25°C		20		V		20		V	%
SR	Slew Rate (Note 8)	25°C	150	200		I	150	200		I	V/ $\mu$ s
$t_s$	Settling Time (Notes 9, 10) 10V Step to 0.05%	25°C		120		V		120		V	ns
Ch $S_p$	Channel Separation ( $f = 10$ MHz)	Full		70		V		70		V	dB

Note 1: A heat sink is required to keep the junction temperature below absolute maximum when the output is shorted.

Note 2:  $V_O = \pm 10V$ .Note 3:  $R_L = 2 k\Omega$ .Note 4: Two tests are performed.  $V_{CM} = 0V$  to  $+10V$  and  $V_{CM} = 0$  to  $-10V$ .Note 5: Two tests are performed.  $V+ = 15V$ , and  $V-$  is changed from  $-5V$  to  $-15V$ .  $V- = -15V$ , and  $V+$  is changed from  $+5V$  to  $+15V$ .Note 6:  $V_O = 100$  mV.Note 7: Full Power Bandwidth guaranteed based on slew rate measurement using:  $FPBW = \text{Slew Rate} / 2 \pi V_{PEAK}$ .

Note 8: Refer to Test Circuit section of data sheet.

Note 9: Settling time measurement are made with techniques in the following reference: "Take The Guesswork Out of Settling-Time Measurements," EDN September 19, 1985.

Note 10:  $A_V = +1$ ,  $R_L = 2 k\Omega$ .

# EL2224/EL2224C

Dual, 60 MHz, Unity Gain Stable, Operational Amplifiers

ELANTEC INC

## Typical Performance Curves

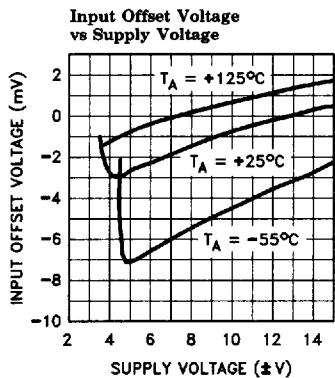

2224-4

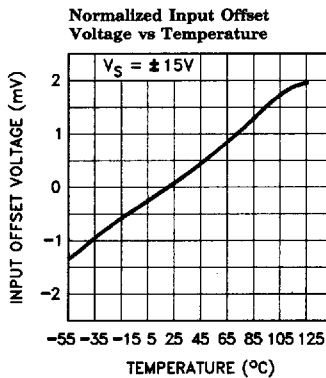

2224-5

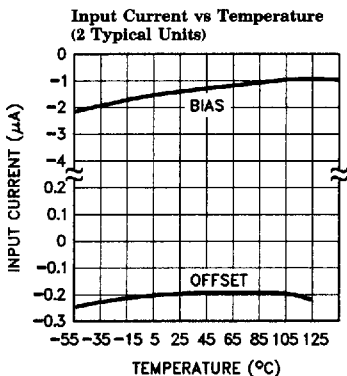

2224-6

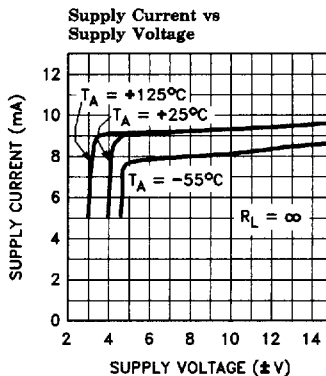

2224-7

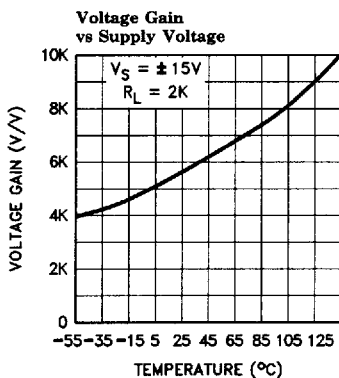

2224-8

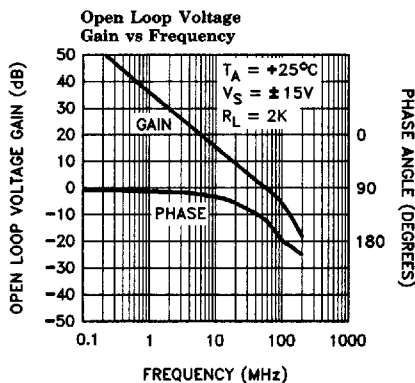

2224-9

ELANTEC INC

# EL2224/EL2224C

## Dual, 60 MHz, Unity Gain Stable, Operational Amplifier

EL2224/EL2224C

### Typical Performance Curves — Contd.

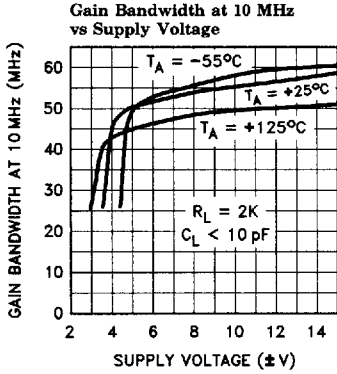

2224-10

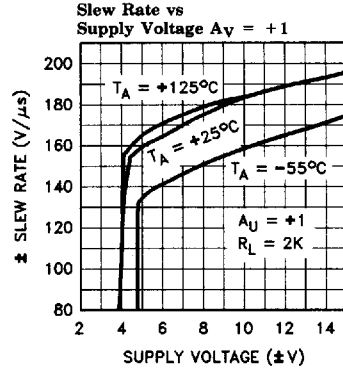

2224-11

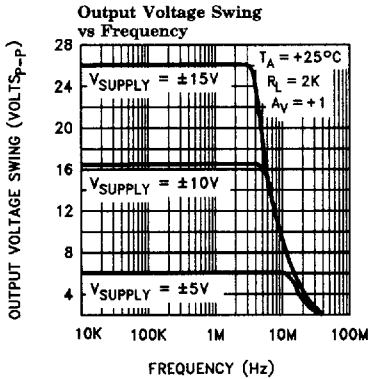

2224-12

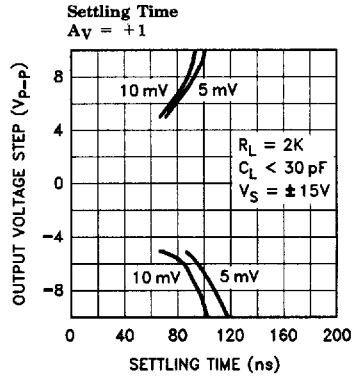

2224-13

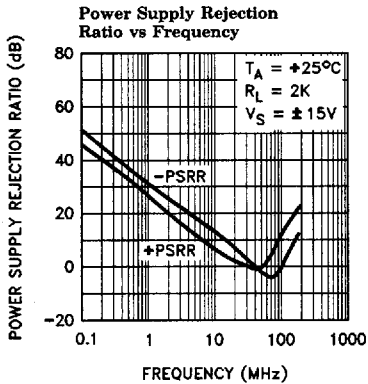

2224-14

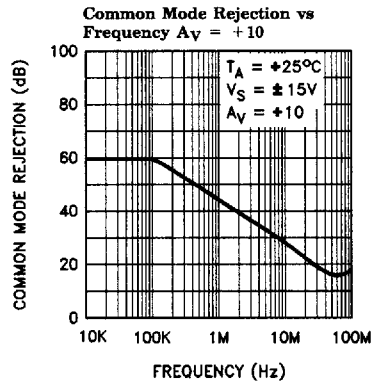

2224-15

EL2224/EL2224C

# EL2224/EL2224C

Dual, 60 MHz, Unity Gain Stable, Operational Amplifier

ELANTEC INC

## Typical Performance Curves — Contd.

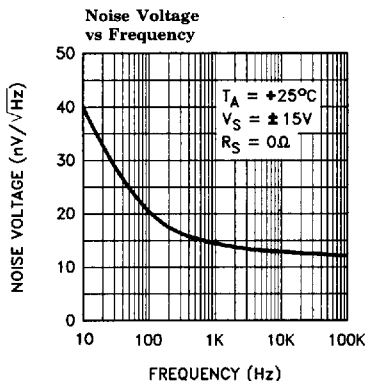

2224-16

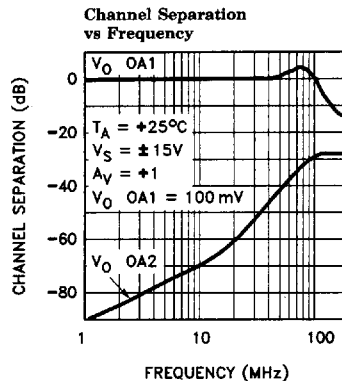

2224-17

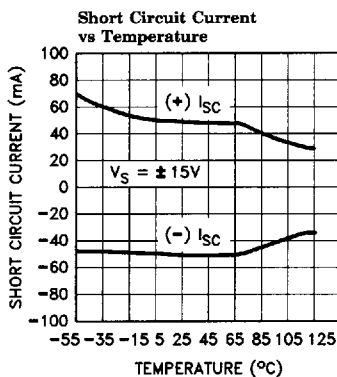

2224-18

### Large Signal Response

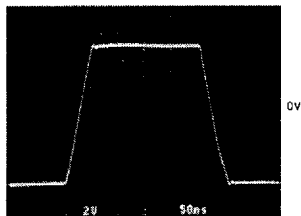

$A_V = +1$   
 $V_{IN} = \pm 5\text{V}$   
 $V_O = \pm 5\text{V}$   
 $R_L = 2\text{k}$

2224-19

### Small Signal Response

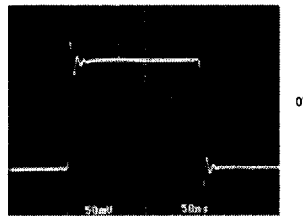

$A_V = +1$   
 $V_{IN} = \pm 100 \text{ mV}$   
 $V_O = \pm 100 \text{ mV}$   
 $R_L = 2\text{k}$

2224-20

ELANTEC INC

**EL2224/EL2224C**

*Dual, 60 MHz, Unity Gain Stable, Operational Amplifier*

EL2224/EL2224C

**Typical Performance Curves — Contd.**

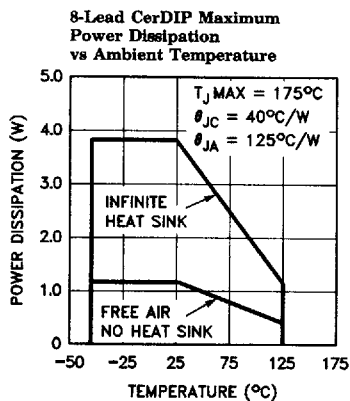

2224-21

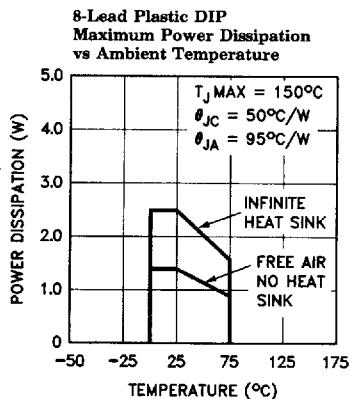

2224-22

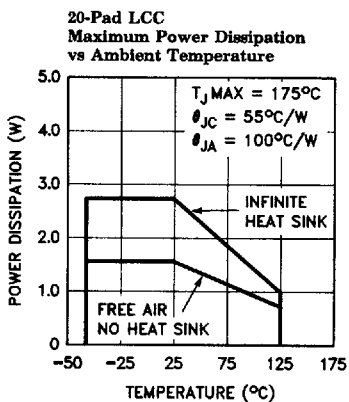

2224-23

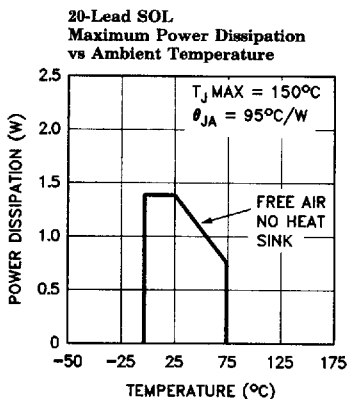

2224-24

**Test Circuit**

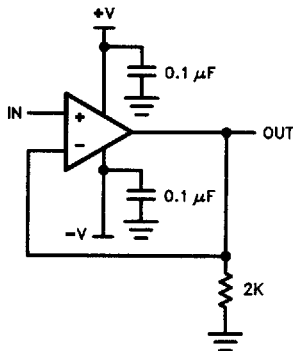

2224-27

**Burn-In Circuit**

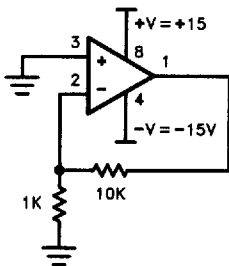

2224-28

Pin numbers are for the 8-lead CerDIP.  
Burn-in circuit is identical for all package types.

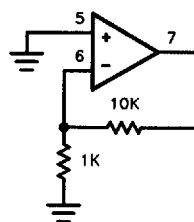

2224-29

$A_V = +1$   
 $C_L \leq 10 \text{ pF}$  Scope Probe

**EL2224/EL2224C**

ELANTEC INC

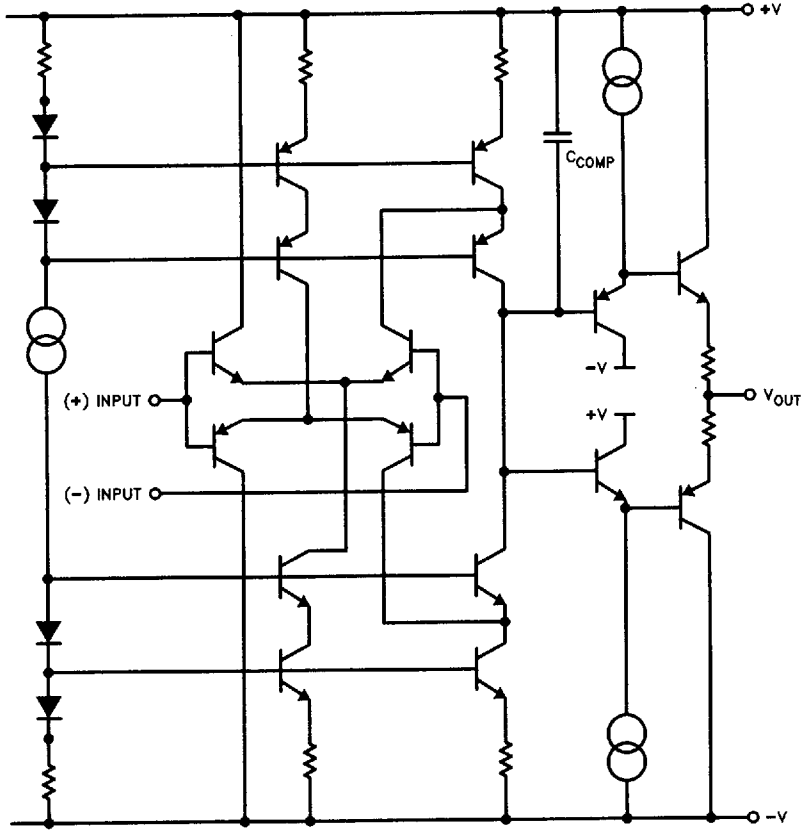
**Dual, 60 MHz, Unity Gain Stable, Operational Amplifier****Simplified Schematic** (one amplifier)

2224-25



ELANTEC INC

**EL2224/EL2224C**  
*Dual, 60 MHz, Unity Gain Stable, Operational Amplifier*

EL2224/EL2224C

**EL2224 Macromodel**

```

* Connections:   + input
*               |
*               | -input
*               |
*               | + Vsupply
*               |
*               | -Vsupply
*               |
*               | output
*               |

```

```

.subckt M2224 3 2 7 4 6

```

## \* Input stage

ie 37 4 4.5mA

r6 36 37 75

r7 38 37 75

rc1 7 30 75

rc2 7 39 75

q1 30 3 36 qn

q2 39 2 38 qna

ediff 33 0 39 30 2.6

rdiff 33 0 1Meg

## \* Compensation Section

ga 0 34 33 0 3m

rh 34 0 1Meg

ch 34 0 15pF

rc 34 40 300

cc 40 0 1pF

## \* Poles

ep 41 0 40 0 1

rpa 41 42 75

cpa 42 0 3pF

rpb 42 43 50

cpb 43 0 3pF

## \* Output Stage

ios1 7 50 0.5mA

ios2 51 4 0.5mA

q3 4 43 50 qp

q4 7 43 51 qn

q5 7 50 52 qn

q6 4 51 53 qp

ros1 52 6 25

ros2 6 53 25

## \* models

.model qn npn(is=800.0E-18 bf=350 tf=0.2nS)

.model qna npn(is=864E-18 bf=400 tf=0.2nS)

.model qp pnp(is=800E-18 bf=60 tf=0.2nS)

.ends

1

**EL2224/EL2224C****Dual, 60 MHz, Unity Gain Stable, Operational Amplifier**

ELANTEC INC

EL2224/EL2224C

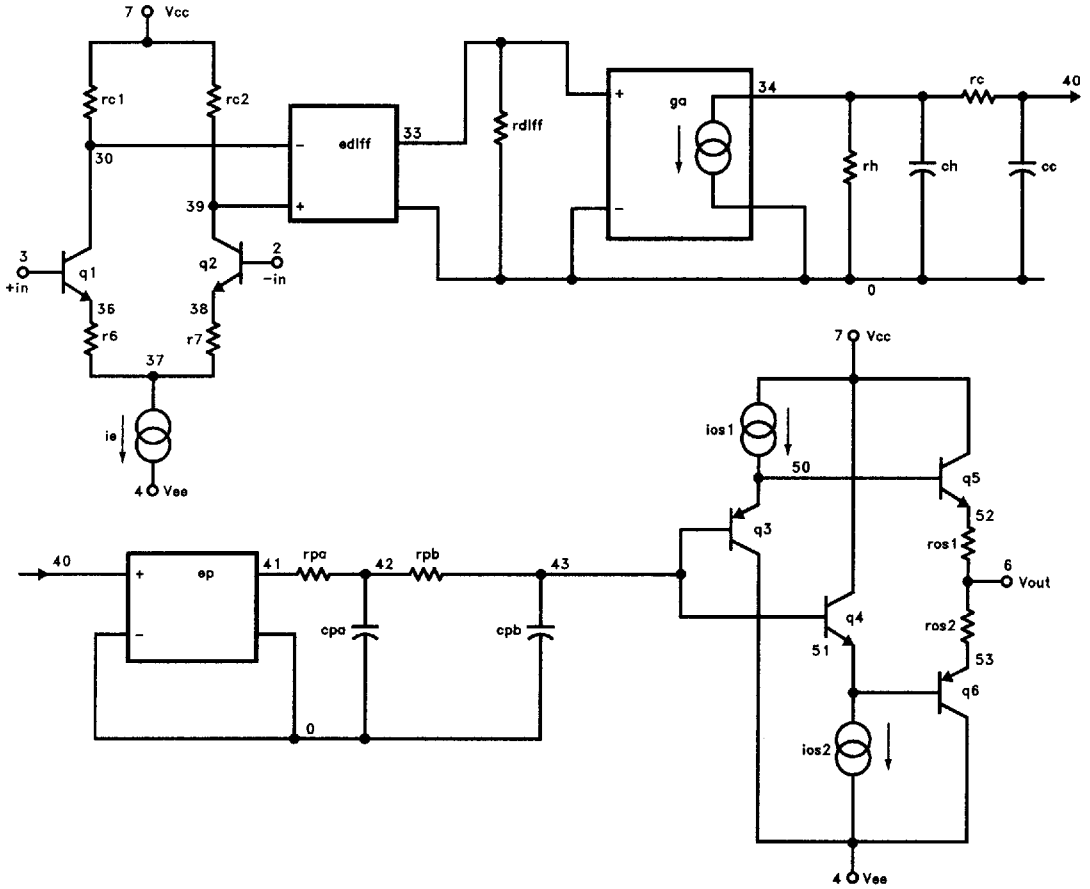
**EL2224 Macromodel — Contd.**

2224-30