

**Triple 200MHz Fixed Gain Amplifier with Enable**



The EL5397A is a triple channel, fixed gain amplifier with a bandwidth of 200MHz, making these amplifiers ideal

for today's high speed video and monitor applications. The EL5397A features internal gain setting resistors and can be configured in a gain of +1, -1 or +2. The same bandwidth is seen in both gain-of-1 and gain-of-2 applications.

With a supply current of just 4mA per amplifier and the ability to run from a single supply voltage from 5V to 10V, these amplifiers are also ideal for hand held, portable or battery powered equipment.

The EL5397A also incorporates an enable and disable function to reduce the supply current to 100µA typical per amplifier. Allowing the CE pin to float or applying a low logic level will enable the amplifier.

For applications where board space is critical, the EL5397A is offered in the 16-pin QSOP package, as well as a 16-pin SO (0.150"). The EL5397A is specified for operation over the full industrial temperature range of -40°C to +85°C.

**Pinout**

**EL5397A**  
**[16-PIN SO (0.150"), QSOP]**  
**TOP VIEW**

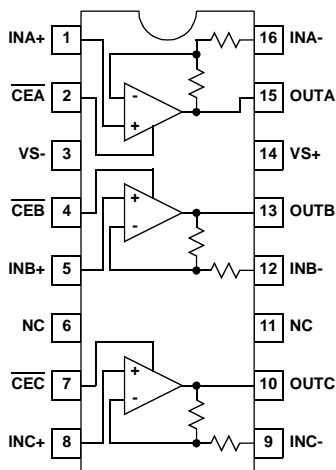

**Features**

- Gain selectable (+1, -1, +2)
- 200MHz -3dB bandwidth ( $A_V = 1, 2$ )
- 4mA supply current (per amplifier)
- Single and dual supply operation, from 5V to 10V or  $\pm 2.5V$  to  $\pm 5V$
- Fast enable/disable
- Available in 16-pin QSOP package
- Single (EL5197) available
- 400MHz, 9mA products available (EL5196 & EL5396)

**Applications**

- Battery-powered equipment
- Hand-held, portable devices
- Video amplifiers
- Cable drivers
- RGB amplifiers
- Test equipment
- Instrumentation
- Current to voltage converters

**Ordering Information**

PART NUMBER	PACKAGE	TAPE & REEL	PKG. NO.
EL5397ACS	16-Pin SO (0.150")	-	MDP0027
EL5397ACS-T7	16-Pin SO (0.150")	7"	MDP0027
EL5397ACS-T13	16-Pin SO (0.150")	13"	MDP0027
EL5397ACU	16-Pin QSOP	-	MDP0040
EL5397ACU-T13	16-Pin QSOP	13"	MDP0040

# EL5397A

## Absolute Maximum Ratings ( $T_A = 25^\circ\text{C}$ )

Supply Voltage between  $V_{S+}$  and  $V_{S-}$  ..... 11V  
 Maximum Continuous Output Current ..... 50mA  
 Operating Junction Temperature .....  $125^\circ\text{C}$   
 Power Dissipation ..... See Curves

Pin Voltages .....  $V_{S-} -0.5\text{V}$  to  $V_{S+} +0.5\text{V}$   
 Storage Temperature .....  $-65^\circ\text{C}$  to  $+150^\circ\text{C}$   
 Operating Temperature .....  $-40^\circ\text{C}$  to  $+85^\circ\text{C}$

**CAUTION:** Stresses above those listed in "Absolute Maximum Ratings" may cause permanent damage to the device. This is a stress only rating and operation of the device at these or any other conditions above those indicated in the operational sections of this specification is not implied.

**IMPORTANT NOTE:** All parameters having Min/Max specifications are guaranteed. Typical values are for information purposes only. Unless otherwise noted, all tests are at the specified temperature and are pulsed tests, therefore:  $T_J = T_C = T_A$

## Electrical Specifications $V_{S+} = +5\text{V}$ , $V_{S-} = -5\text{V}$ , $R_L = 150\Omega$ , $T_A = 25^\circ\text{C}$ unless otherwise specified.

PARAMETER	DESCRIPTION	CONDITIONS	MIN	TYP	MAX	UNIT
<b>AC PERFORMANCE</b>						
BW	-3dB Bandwidth	$A_V = +1$		200		MHz
		$A_V = +2$		200		MHz
		$A_V = -1$		200		MHz
BW1	0.1dB Bandwidth			20		MHz
SR	Slew Rate	$V_O = -2.5\text{V}$ to $+2.5\text{V}$ , $A_V = +2$	1800	2100		V/ $\mu\text{s}$
$t_S$	0.1% Settling Time	$V_{OUT} = -2.5\text{V}$ to $+2.5\text{V}$ , $A_V = -1$		12		ns
$C_S$	Channel Separation	$f = 5\text{MHz}$		67		dB
$e_N$	Input Voltage Noise			4.8		nV/ $\sqrt{\text{Hz}}$
$i_{N-}$	IN- Input Current Noise			17		pA/ $\sqrt{\text{Hz}}$
$i_{N+}$	IN+ Input Current Noise			50		pA/ $\sqrt{\text{Hz}}$
dG	Differential Gain Error (Note 1)	$A_V = +2$		0.03		%
dP	Differential Phase Error (Note 1)	$A_V = +2$		0.04		$^\circ$
<b>DC PERFORMANCE</b>						
$V_{OS}$	Offset Voltage		-10	1	10	mV
$T_C V_{OS}$	Input Offset Voltage Temperature Coefficient	Measured from $T_{MIN}$ to $T_{MAX}$		5		$\mu\text{V}/^\circ\text{C}$
$A_E$	Gain Error	$V_O = -3\text{V}$ to $+3\text{V}$	-2		2	%
$R_F, R_G$	Internal $R_F$ and $R_G$		320	400	480	$\Omega$
<b>INPUT CHARACTERISTICS</b>						
CMIR	Common Mode Input Range		$\pm 3\text{V}$	$\pm 3.3\text{V}$		V
$+I_{IN}$	+ Input Current		-60	1	60	$\mu\text{A}$
$-I_{IN}$	- Input Current		-30	1	30	$\mu\text{A}$
$R_{IN}$	Input Resistance			45		k $\Omega$
$C_{IN}$	Input Capacitance			0.5		pF
<b>OUTPUT CHARACTERISTICS</b>						
$V_O$	Output Voltage Swing	$R_L = 150\Omega$ to GND	$\pm 3.4\text{V}$	$\pm 3.7\text{V}$		V
		$R_L = 1\text{k}\Omega$ to GND	$\pm 3.8\text{V}$	$\pm 4.0\text{V}$		V
$I_{OUT}$	Output Current	$R_L = 10\Omega$ to GND	95	120		mA
<b>SUPPLY</b>						
$I_{SON}$	Supply Current - Enabled	No load, $V_{IN} = 0\text{V}$	3	4	5	mA
$I_{SOFF}$	Supply Current - Disabled	No load, $V_{IN} = 0\text{V}$		100	150	$\mu\text{A}$

## EL5397A

### Electrical Specifications $V_{S+} = +5V$ , $V_{S-} = -5V$ , $R_L = 150\Omega$ , $T_A = 25^\circ C$ unless otherwise specified. (Continued)

PARAMETER	DESCRIPTION	CONDITIONS	MIN	TYP	MAX	UNIT
PSRR	Power Supply Rejection Ratio	DC, $V_S = \pm 4.75V$ to $\pm 5.25V$	55	75		dB
-IPSR	- Input Current Power Supply Rejection	DC, $V_S = \pm 4.75V$ to $\pm 5.25V$	-2		2	$\mu A/V$
<b>ENABLE</b>						
$t_{EN}$	Enable Time (Note 2)			40		ns
$t_{DIS}$	Disable Time (Note 2)			600		ns
$I_{IHCE}$	CE Pin Input High Current	$\overline{CE} = V_{S+}$		0.8	6	$\mu A$
$I_{ILCE}$	CE Pin Input Low Current	$\overline{CE} = V_{S-}$		0	-0.1	$\mu A$
$V_{IHCE}$	CE Input High Voltage for Power-down		$V_{S+} - 1$			V
$V_{ILCE}$	CE Input Low Voltage for Power-up				$V_{S+} - 3$	V

#### NOTES:

- Standard NTSC test, AC signal amplitude = 286mV<sub>p-p</sub>, f = 3.58MHz
- Measured from the application of  $\overline{CE}$  logic until the output voltage is at the 50% point between initial and final values

Typical Performance Curves

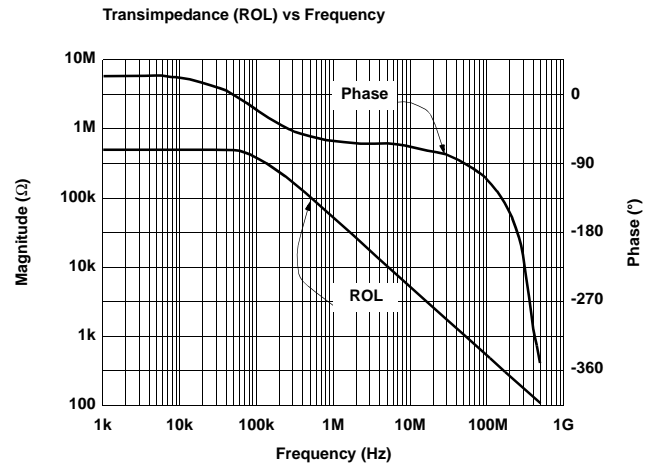
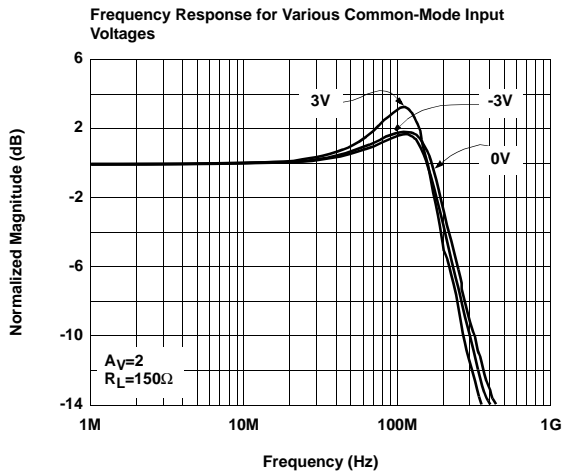
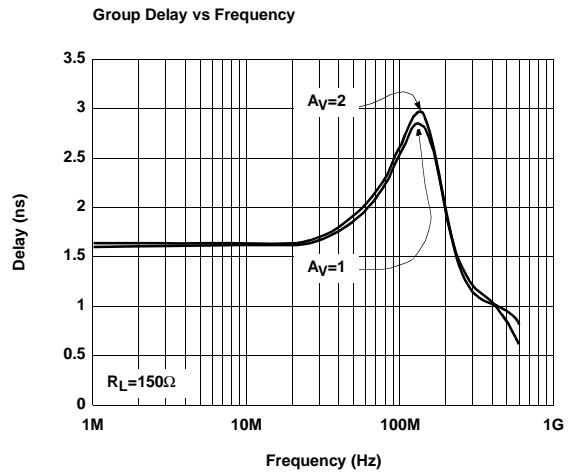
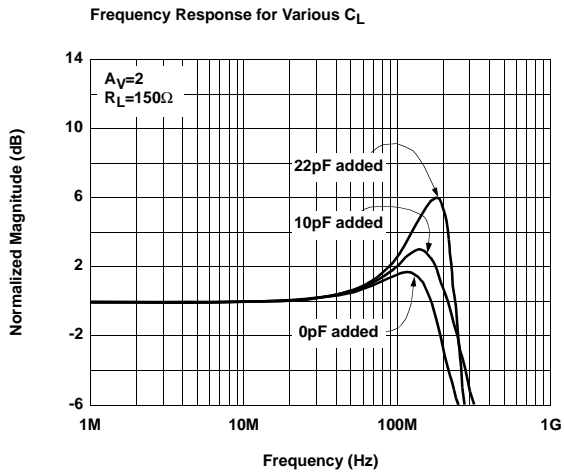
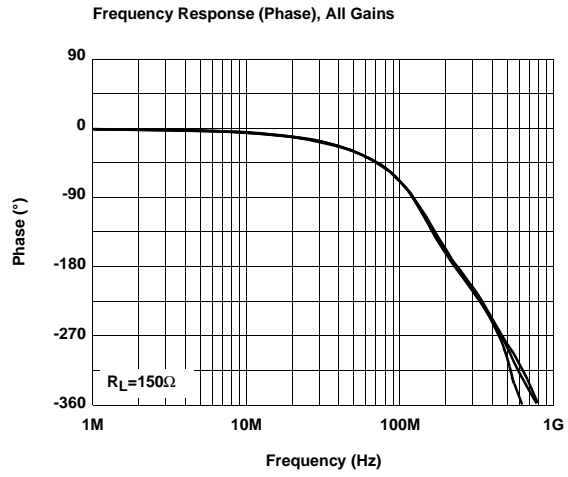
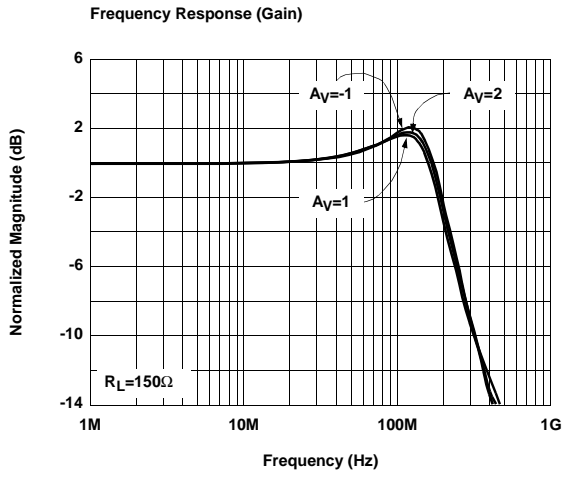

Typical Performance Curves (Continued)

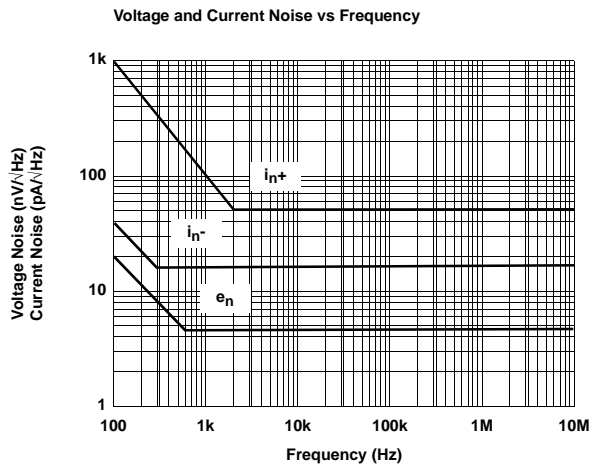
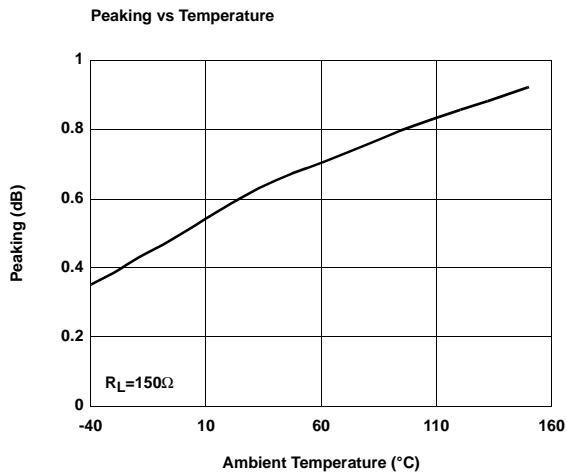
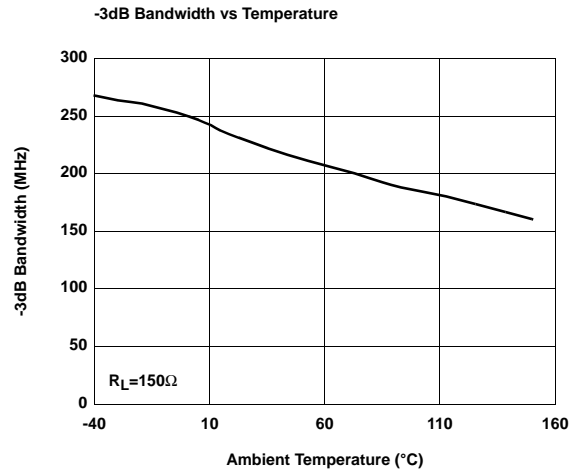
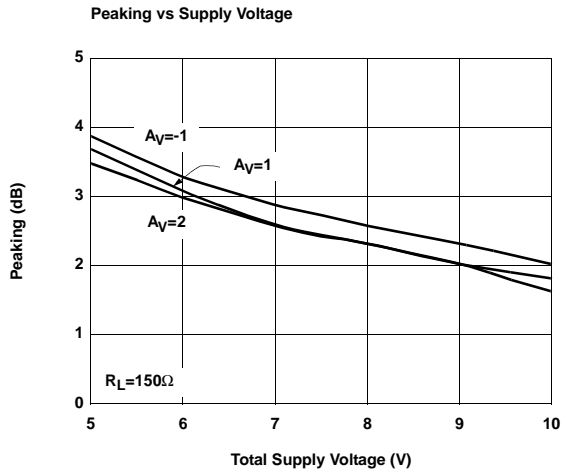
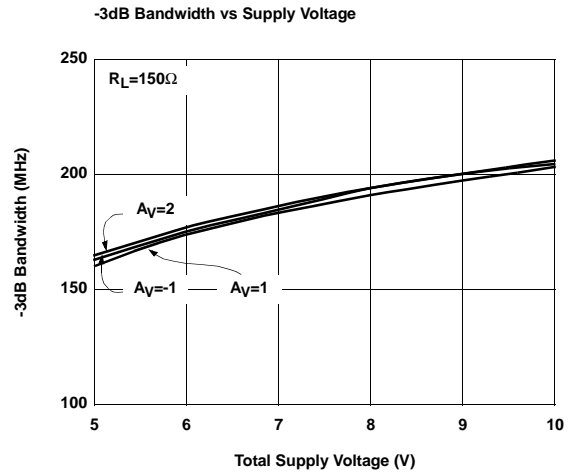
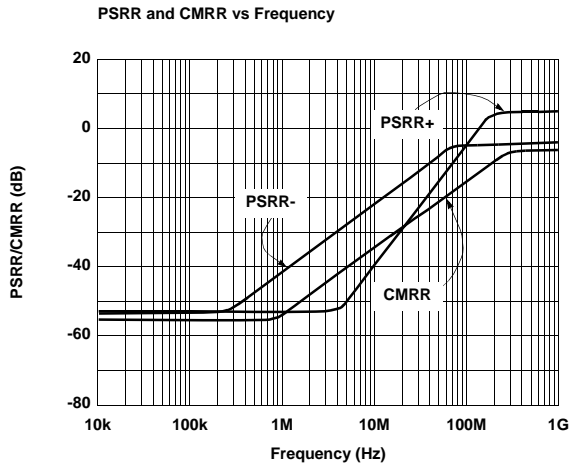

Typical Performance Curves (Continued)

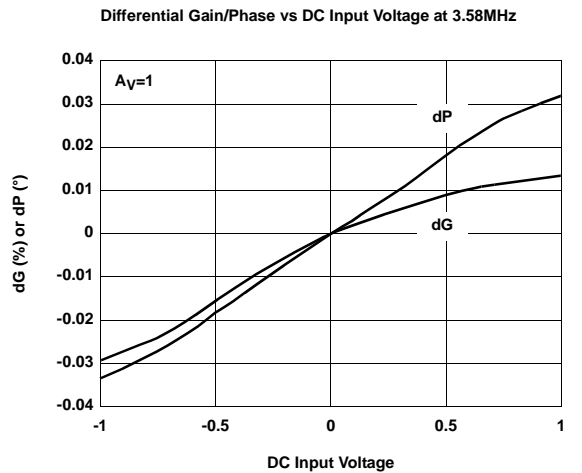
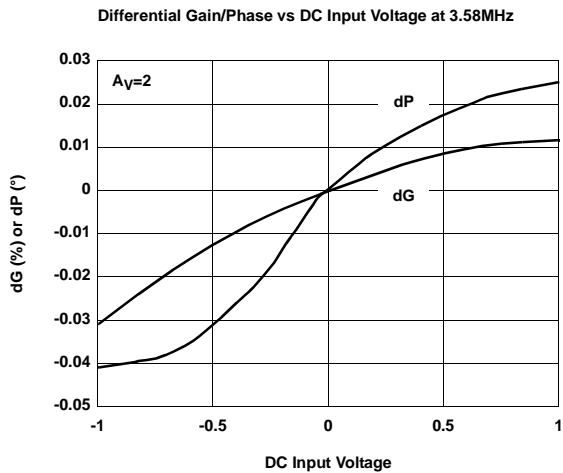
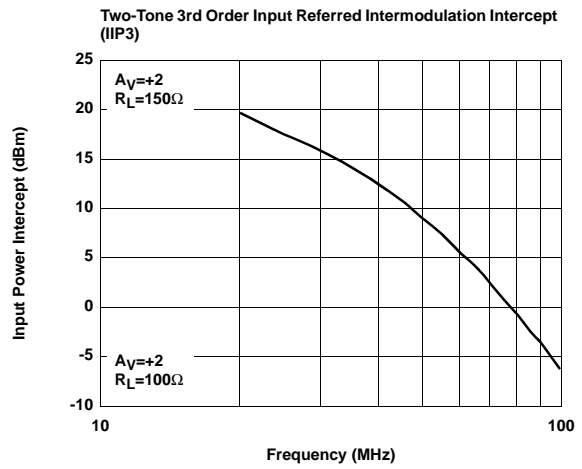
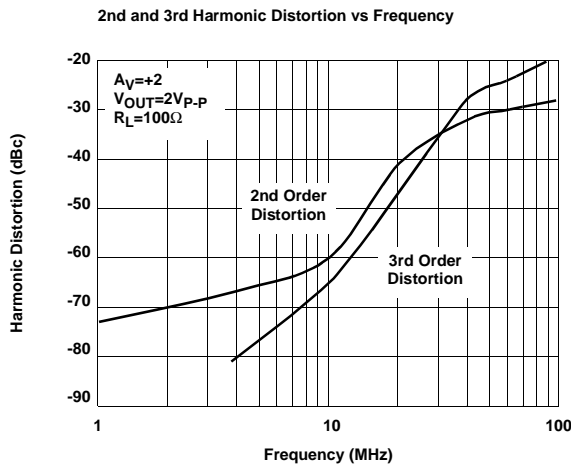
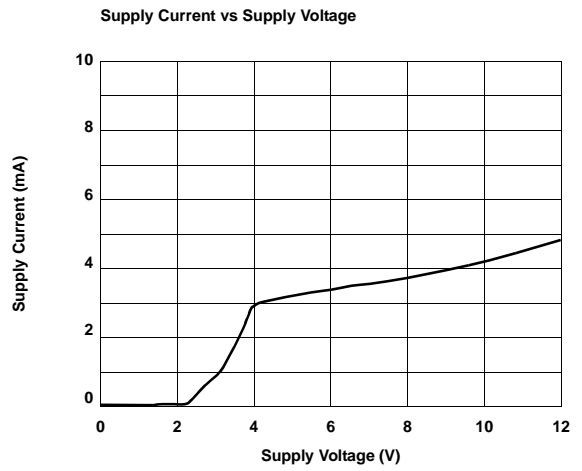
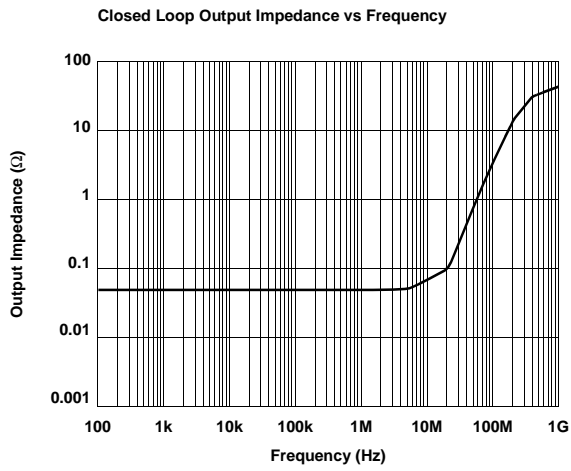

Typical Performance Curves (Continued)

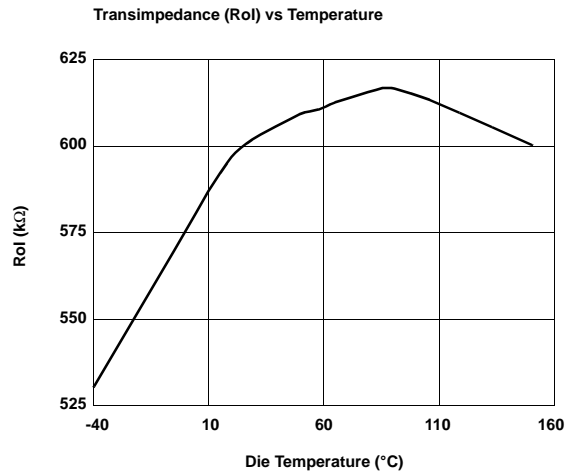
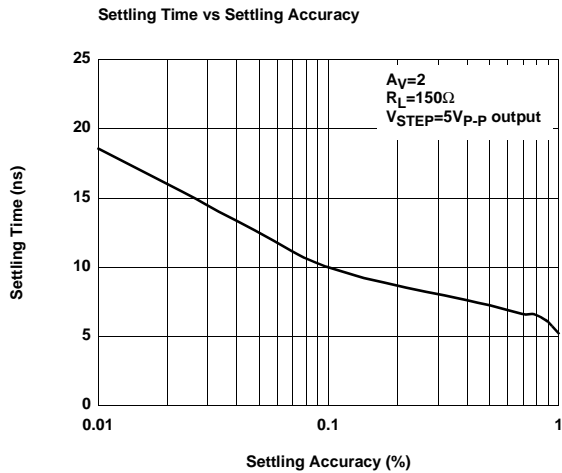
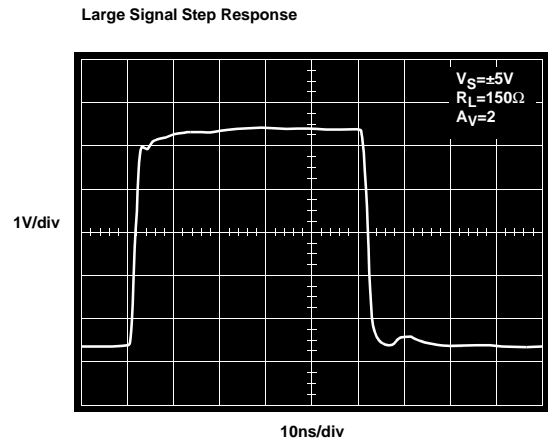
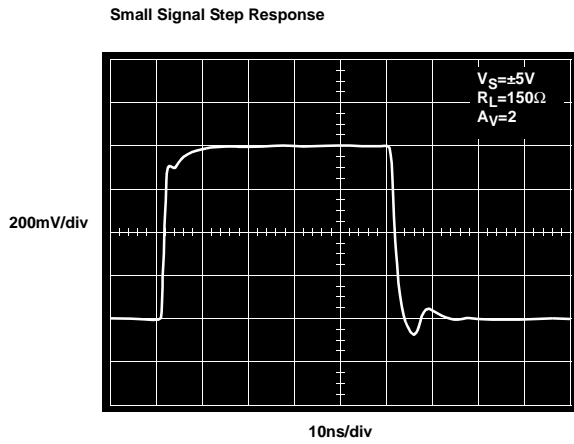
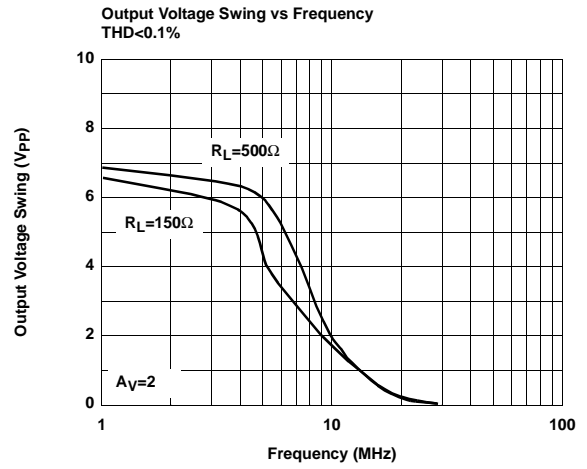
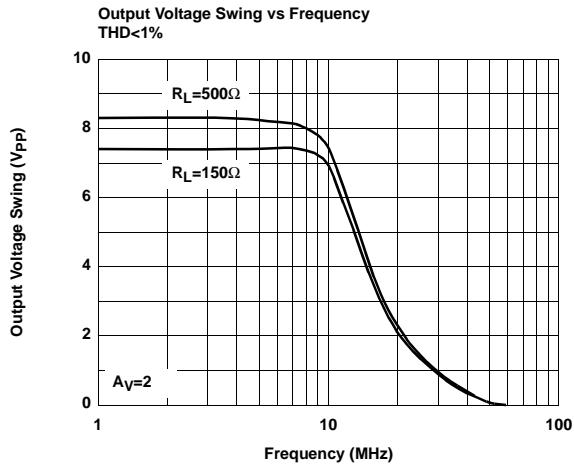

Typical Performance Curves (Continued)

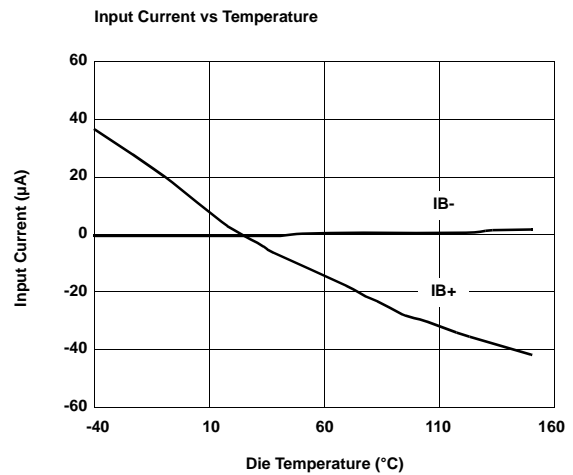
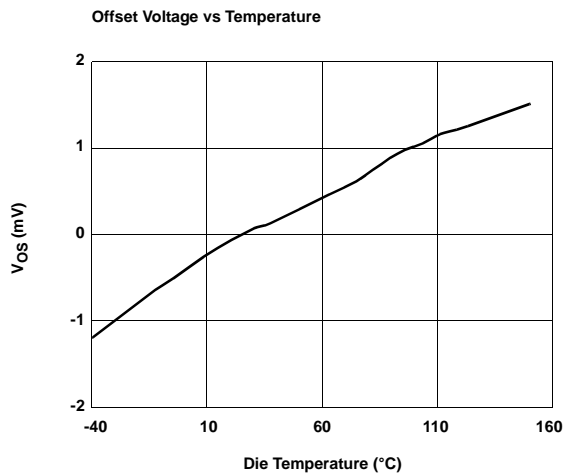
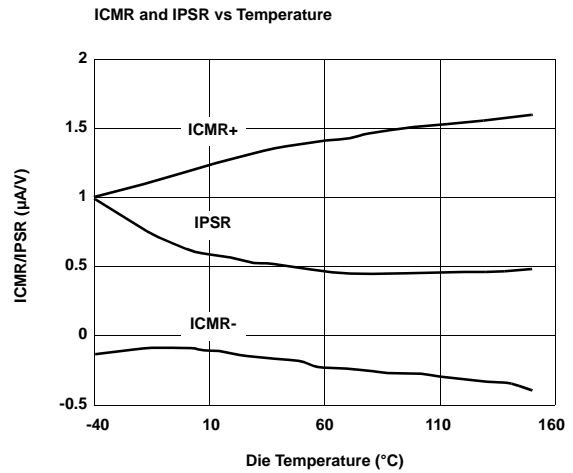
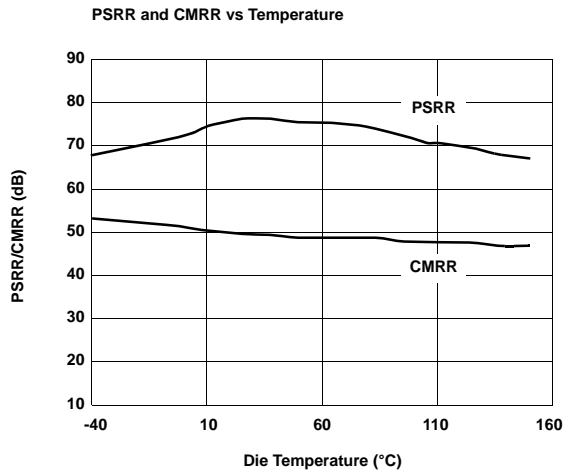
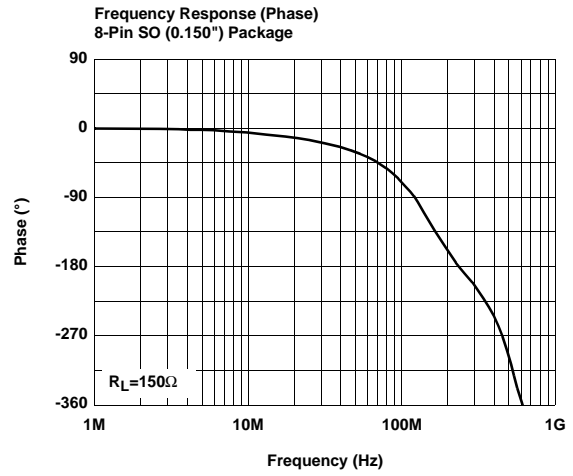
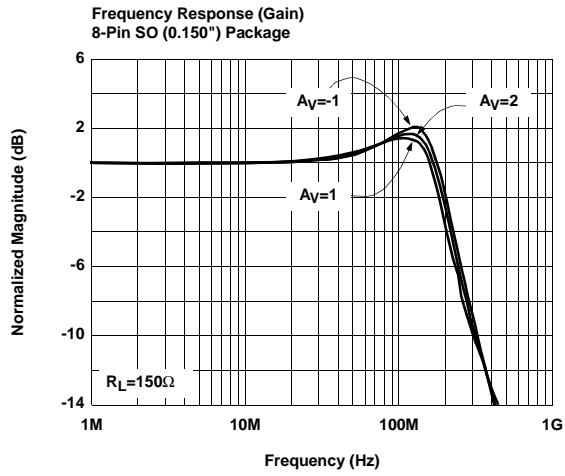



Typical Performance Curves (Continued)

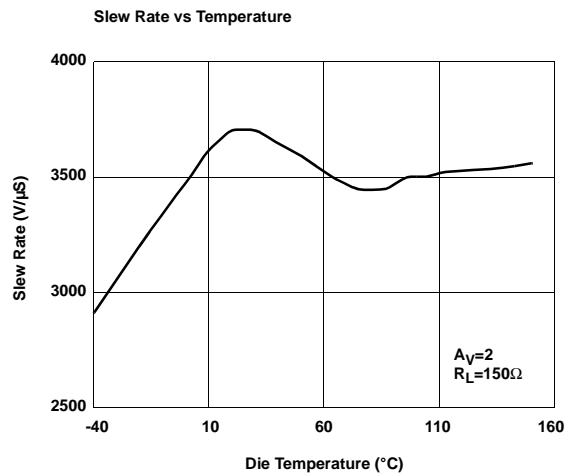
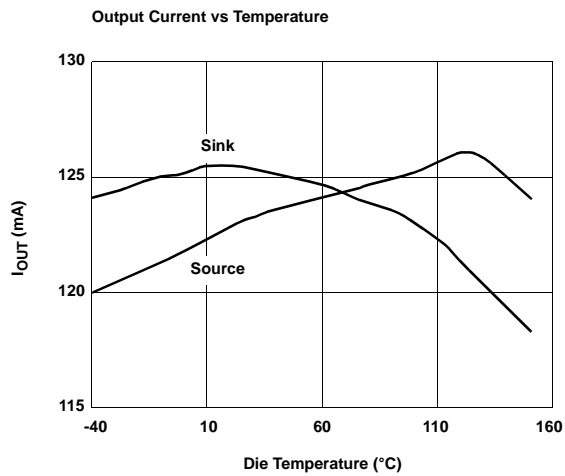
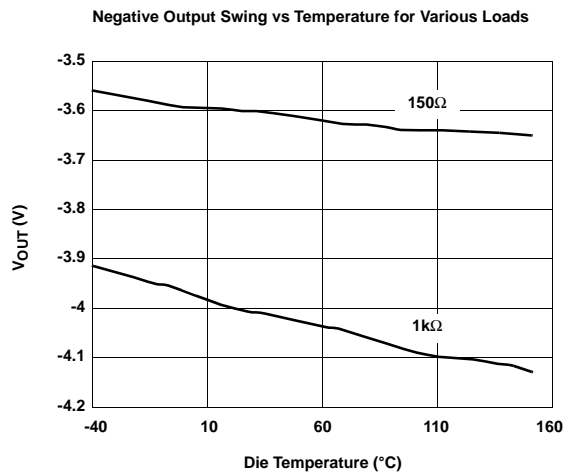
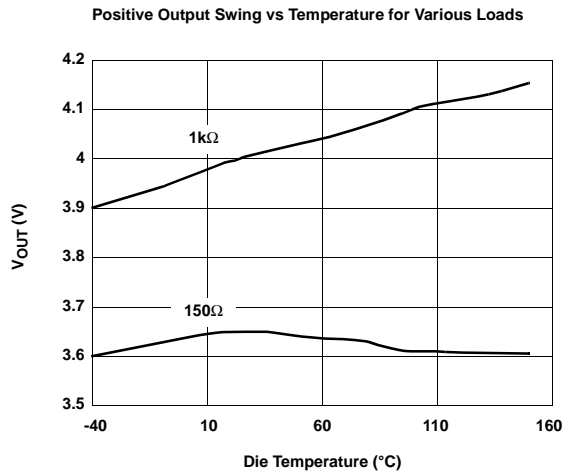
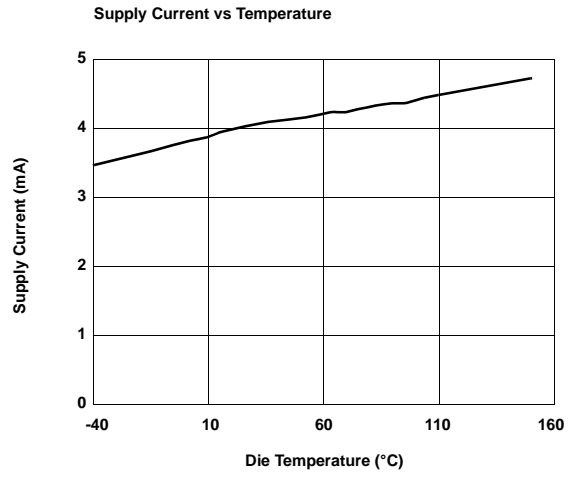
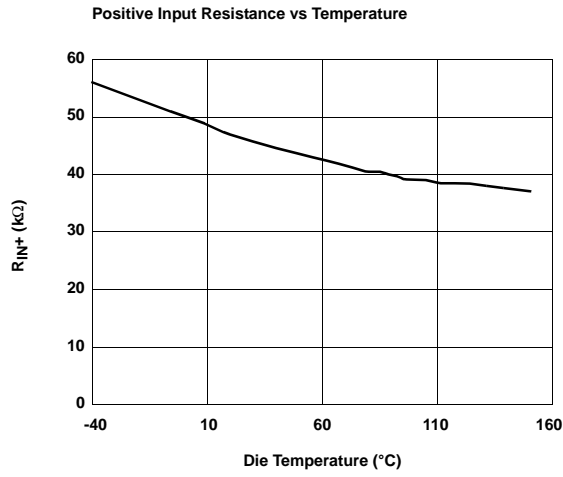

Typical Performance Curves (Continued)

Enable Response

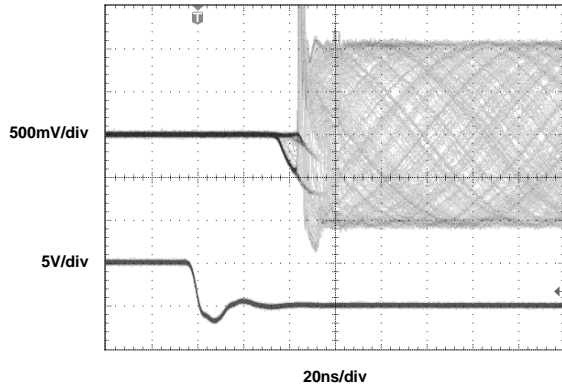

Disable Response

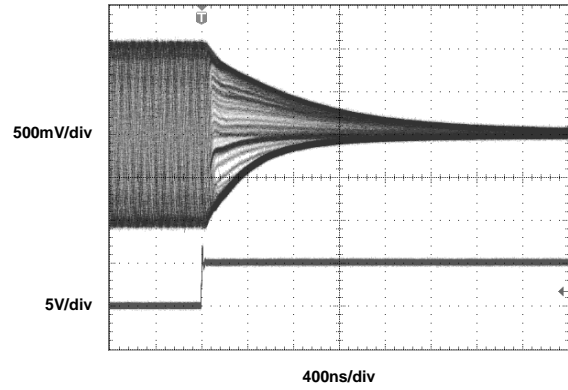

Package Power Dissipation vs Ambient Temperature  
JEDEC JESD51-3 Low Effective Thermal Conductivity Test Board

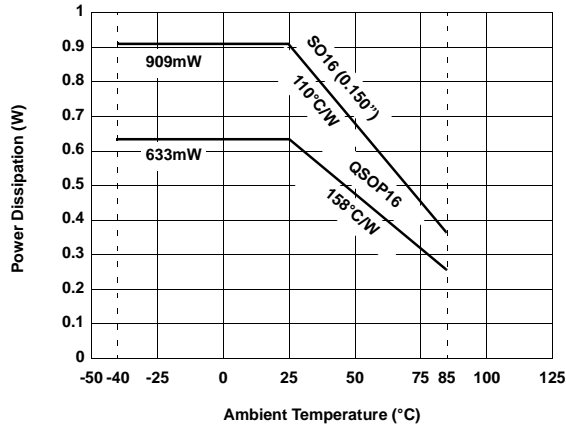

Package Power Dissipation vs Ambient Temperature  
JEDEC JESD51-7 High Effective Thermal Conductivity Test Board

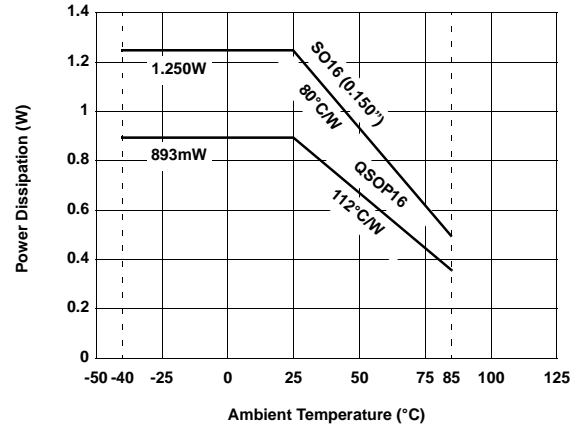

Pin Descriptions

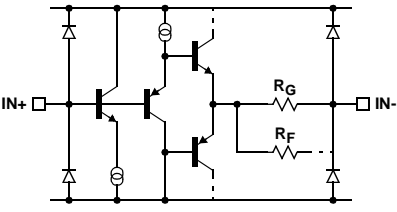
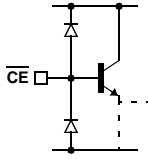
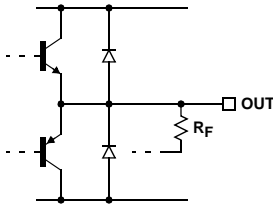
16-PIN SO (0.150")	16-PIN QSOP	PIN NAME	FUNCTION	EQUIVALENT CIRCUIT
1	1	INA+	Non-inverting input, channel A	 <p>Circuit 1</p>
2	2	$\overline{\text{CEA}}$	Chip enable, channel A	 <p>Circuit 2</p>
3	3	VS-	Negative supply	
4	4	$\overline{\text{CEB}}$	Chip enable, channel B	(See circuit 2)
5	5	INB+	Non-inverting input, channel B	(See circuit 1)
6, 11	6, 11	NC	Not connected	
7	7	$\overline{\text{CEC}}$	Chip enable, channel C	(See circuit 2)
8	8	INC+	Non-inverting input, channel C	(See circuit 1)
9	9	INC-	Inverting input, channel C	(See circuit 1)
10	10	OUTC	Output, channel C	 <p>Circuit 3</p>
12	12	INB-	Inverting input, channel B	(See circuit 1)
13	13	OUTB	Output, channel B	(See circuit 3)
14	14	VS+	Positive supply	
15	15	OUTA	Output, channel A	(See circuit 3)
16	16	INA-	Inverting input, channel A	(See circuit 1)

## Applications Information

### Product Description

The EL5397A is a triple channel fixed gain amplifier that offers a wide -3dB bandwidth of 200MHz and a low supply current of 4mA. The EL5397A works with supply voltages ranging from a single 5V to 10V and they are also capable of swinging to within 1V of either supply on the output. This combination of high bandwidth and low power, together with aggressive pricing make the EL5397A the ideal choice for many low-power/high-bandwidth applications such as portable, handheld, or battery-powered equipment.

For varying bandwidth and higher gains, consider the EL5191 with 1GHz on a 9mA supply current or the EL5193 with 300MHz on a 4mA supply current. Versions include single, dual, and triple amp packages with 5-pin SOT23, 16-pin QSOP, and 8-pin or 16-pin SO outlines.

### Power Supply Bypassing and Printed Circuit Board Layout

As with any high frequency device, good printed circuit board layout is necessary for optimum performance. Low impedance ground plane construction is essential. Surface mount components are recommended, but if leaded components are used, lead lengths should be as short as possible. The power supply pins must be well bypassed to reduce the risk of oscillation. The combination of a 4.7 $\mu$ F tantalum capacitor in parallel with a 0.01 $\mu$ F capacitor has been shown to work well when placed at each supply pin.

### Disable/Power-Down

The EL5397A amplifier can be disabled placing its output in a high impedance state. When disabled, the amplifier supply current is reduced to < 150 $\mu$ A. The EL5397A is disabled when its  $\overline{\text{CE}}$  pin is pulled up to within 1V of the positive supply. Similarly, the amplifier is enabled by floating or pulling its  $\overline{\text{CE}}$  pin to at least 3V below the positive supply. For  $\pm 5$ V supply, this means that an EL5397A amplifier will be enabled when  $\overline{\text{CE}}$  is 2V or less, and disabled when  $\overline{\text{CE}}$  is above 4V. Although the logic levels are not standard TTL, this choice of logic voltages allows the EL5397A to be enabled by tying  $\overline{\text{CE}}$  to ground, even in 5V single supply applications. The  $\overline{\text{CE}}$  pin can be driven from CMOS outputs.

### Gain Setting

The EL5397A is built with internal feedback and gain resistors. The internal feedback resistors have equal value; as a result, the amplifier can be configured into gain of +1, -1, and +2 without any external resistors. Figure 1 shows the amplifier in gain of +2 configuration. The gain error is  $\pm 2\%$  maximum. Figure 2 shows the amplifier in gain of -1 configuration. For gain of +1, IN+ and IN- should be connected together as shown in Figure 3. This configuration avoids the effects of any parasitic capacitance on the IN- pin. Since the internal feedback and gain resistors change with

temperature and process, external resistor should not be used to adjust the gain settings.

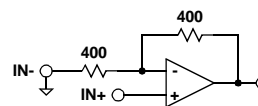

FIGURE 1.  $A_V = +2$

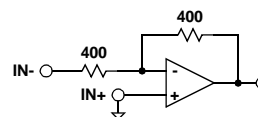

FIGURE 2.  $A_V = -1$

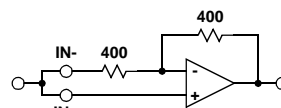

FIGURE 3.  $A_V = +1$

### Supply Voltage Range and Single-Supply Operation

The EL5397A has been designed to operate with supply voltages having a span of greater than or equal to 5V and less than 11V. In practical terms, this means that the EL5397A will operate on dual supplies ranging from  $\pm 2.5$ V to  $\pm 5$ V. With single-supply, the EL5397A will operate from 5V to 10V.

As supply voltages continue to decrease, it becomes necessary to provide input and output voltage ranges that can get as close as possible to the supply voltages. The EL5397A has an input range which extends to within 2V of either supply. So, for example, on  $\pm 5$ V supplies, the EL5397A has an input range which spans  $\pm 3$ V. The output range of the EL5397A is also quite large, extending to within 1V of the supply rail. On a  $\pm 5$ V supply, the output is therefore capable of swinging from -4V to +4V. Single-supply output range is larger because of the increased negative swing due to the external pull-down resistor to ground. Figure 4 shows

an AC-coupled, gain of +2, +5V single supply circuit configuration.

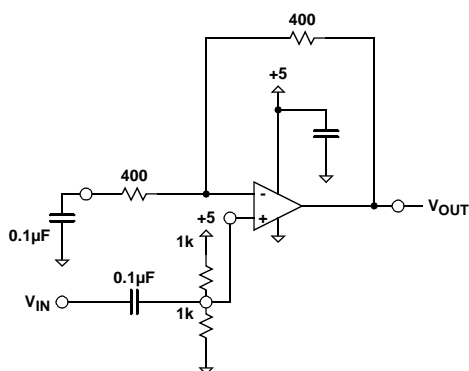

FIGURE 4.

**Video Performance**

For good video performance, an amplifier is required to maintain the same output impedance and the same frequency response as DC levels are changed at the output. This is especially difficult when driving a standard video load of 150Ω, because of the change in output current with DC level. Previously, good differential gain could only be achieved by running high idle currents through the output transistors (to reduce variations in output impedance.) These currents were typically comparable to the entire 4mA supply current of each EL5397A amplifier. Special circuitry has been incorporated in the EL5397A to reduce the variation of output impedance with current output. This results in dG and dP specifications of 0.03% and 0.04°, while driving 150Ω at a gain of 2.

Video performance has also been measured with a 500Ω load at a gain of +1. Under these conditions, the EL5397A has dG and dP specifications of 0.03% and 0.04°, respectively.

**Output Drive Capability**

In spite of its low 4mA of supply current, the EL5397A is capable of providing a minimum of ±95mA of output current. With a minimum of ±95mA of output drive.

**Driving Cables and Capacitive Loads**

When used as a cable driver, double termination is always recommended for reflection-free performance. For those applications, the back-termination series resistor will decouple the EL5397A from the cable and allow extensive capacitive drive. However, other applications may have high

capacitive loads without a back-termination resistor. In these applications, a small series resistor (usually between 5Ω and 50Ω) can be placed in series with the output to eliminate most peaking.

**Current Limiting**

The EL5397A has no internal current-limiting circuitry. If the output is shorted, it is possible to exceed the Absolute Maximum Rating for output current or power dissipation, potentially resulting in the destruction of the device.

**Power Dissipation**

With the high output drive capability of the EL5397A, it is possible to exceed the 125°C Absolute Maximum junction temperature under certain very high load current conditions. Generally speaking when  $R_L$  falls below about 25Ω, it is important to calculate the maximum junction temperature ( $T_{JMAX}$ ) for the application to determine if power supply voltages, load conditions, or package type need to be modified for the EL5397A to remain in the safe operating area. These parameters are calculated as follows:

$$T_{JMAX} = T_{MAX} + (\theta_{JA} \times n \times PD_{MAX})$$

where:

- $T_{MAX}$  = Maximum ambient temperature
- $\theta_{JA}$  = Thermal resistance of the package
- n = Number of amplifiers in the package
- $PD_{MAX}$  = Maximum power dissipation of each amplifier in the package

$PD_{MAX}$  for each amplifier can be calculated as follows:

$$PD_{MAX} = (2 \times V_S \times I_{SMAX}) + \left[ (V_S - V_{OUTMAX}) \times \frac{V_{OUTMAX}}{R_L} \right]$$

where:

- $V_S$  = Supply voltage
- $I_{SMAX}$  = Maximum supply current
- $V_{OUTMAX}$  = Maximum output voltage (required)
- $R_L$  = Load resistance

All Intersil U.S. products are manufactured, assembled and tested utilizing ISO9000 quality systems. Intersil Corporation's quality certifications can be viewed at [www.intersil.com/design/quality](http://www.intersil.com/design/quality)

*Intersil products are sold by description only. Intersil Corporation reserves the right to make changes in circuit design, software and/or specifications at any time without notice. Accordingly, the reader is cautioned to verify that data sheets are current before placing orders. Information furnished by Intersil is believed to be accurate and reliable. However, no responsibility is assumed by Intersil or its subsidiaries for its use; nor for any infringements of patents or other rights of third parties which may result from its use. No license is granted by implication or otherwise under any patent or patent rights of Intersil or its subsidiaries.*

For information regarding Intersil Corporation and its products, see [www.intersil.com](http://www.intersil.com)