

Laser Driver Oscillator



The EL6205 consists of a variable amplitude, push only, oscillator that also supplies the laser DC current. It is

designed to easily interface to existing ROM controllers, reducing parts count, and power dissipation.

The reduction of parts count and the small package allows the oscillator to be placed closer to the laser, thus reducing EMI. Also, the turn-on and turn-off edges are slew rate limited to reduce higher harmonics.

The total current drawn from the power supply can be less than the laser threshold current due to the unique push-only modulation method. The average current is less than the peak oscillator current, and can be less than half of the oscillator current. The power control current supplied from the main board is reduced to less than 2mA.

One external resistor sets the oscillator frequency. A current applied to the IIN terminal determines the amplitude of the oscillator and laser DC current. If the oscillator amplitude is set very low, the output and oscillator are disabled. The part is available in the space-saving 6-pin SOT-23 package. It is specified for operation from 0°C to +70°C.

Pinout

EL6205
(6-PIN SOT-23)
TOP VIEW

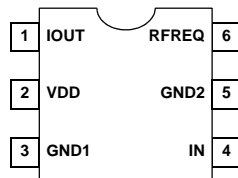

Features

- Low power dissipation
- Reduced parts count from the conventional solution
- User-selectable frequency from 60MHz to 600MHz controlled with a single resistor
- User-selectable amplitude from 15mA_{PK-PK} to 100mA_{PK-PK} controlled by 0.3mA to 2mA input current
- Auto turn-off threshold
- Soft edges for reduced EMI
- Small 6-pin SOT-23 package

Applications

- DVD players
- DVD-ROM drives
- Combo drives
- MO drives
- General purpose laser noise reduction
- Local oscillator capability

Ordering Information

PART NUMBER	PACKAGE	TAPE & REEL	PKG. DWG. #
EL6205CW-T7	6-Pin SOT-23	7" (3K pcs)	MDP0038
EL6205CW-T7A	6-Pin SOT-23	7" (250 pcs)	MDP0038

Absolute Maximum Ratings ($T_A = 25^\circ\text{C}$)

Voltages Applied to:

V_{DD}	-0.5V to +6.0V
I_{OUT}	-0.5V to +6.0V
$R_{FREQ, IN}$	-0.5V to +6.0V

Operating Ambient Temperature	0°C to +70°C
Maximum Die Operating Temperature	+150°C
Storage Temperature Range	-65°C to +150°C
Output Current	100mA _{PK-PK}
Power Dissipation (max)	See Curves

CAUTION: Stresses above those listed in "Absolute Maximum Ratings" may cause permanent damage to the device. This is a stress only rating and operation of the device at these or any other conditions above those indicated in the operational sections of this specification is not implied.

IMPORTANT NOTE: All parameters having Min/Max specifications are guaranteed. Typical values are for information purposes only. Unless otherwise noted, all tests are at the specified temperature and are pulsed tests, therefore: $T_J = T_C = T_A$

Supply & Reference Voltage Characteristics $V_{DD} = +5V, T_A = 25^\circ\text{C}, R_L = 10\Omega, R_{FREQ} = 5210\Omega (F_{OSC} = 350\text{MHz}), I_{IN} = 1\text{mA}$
 $(I_{OUT} = 50\text{mA}_{P-P} \text{ measured at } 60\text{MHz}), V_{OUT} = 2.2V$

PARAMETER	DESCRIPTION	CONDITIONS	MIN	TYP	MAX	UNIT
PSOR	Power Supply Operating Range		4.5		5.5	V
I_{SO}	Supply Current Disabled	$I_{IN} \leq 100\mu\text{A}$		550	750	μA
I_{STYP}	Supply Current Typical Conditions	$R_{FREQ} = 5.21\text{k}\Omega$ (includes laser current)	25	32	38	mA
I_{SLO}	Supply Current Low Conditions	$R_{FREQ} = 30.5\text{k}\Omega, I_{IN} = 300\mu\text{A}$ (includes laser current)		10		mA
I_{SHI}	Supply Current High Conditions	$R_{FREQ} = 3.05\text{k}\Omega, I_{IN} = 2\text{mA}$ (includes laser current)		53		mA
V_{FREQ}	Voltage at R_{FREQ} Pin			1.27		V
R_{IN}	Input Impedance			500		Ω

Oscillator Characteristics $V_{DD} = +5V, T_A = 25^\circ\text{C}, R_L = 10\Omega, R_{FREQ} = 5210\Omega (F_{OSC} = 350\text{MHz}), I_{IN} = 1\text{mA}$ ($I_{OUT} = 50\text{mA}_{P-P}$ measured at 60MHz), $V_{OUT} = 2.2V$

PARAMETER	DESCRIPTION	CONDITIONS	MIN	TYP	MAX	UNIT
F_{OSC}	Frequency Tolerance	Unit-unit frequency variation	300	350	400	MHz
F_{HIGH}	Frequency Range High	$R_{FREQ} = 3.05\text{k}\Omega$		600		MHz
F_{LOW}	Frequency Range Low	$R_{FREQ} = 30.5\text{k}\Omega$		60		MHz
T_{COSC}	Frequency Temperature Sensitivity	0°C to 70°C ambient		50		ppm/°C
$PSRR_{OSC}$	Frequency Change $\Delta F/F$	V_{DD} from 4.5V to 5.5V		1		%

Driver Characteristics $V_{DD} = +5V, T_A = 25^\circ\text{C}, R_L = 10\Omega, R_{FREQ} = 30.5\text{k}\Omega (F_{OSC} = 60\text{MHz}), I_{IN} = 1\text{mA}$ ($I_{OUT} = 50\text{mA}_{P-P}$ measured at 60MHz), $V_{OUT} = 2.2V$

PARAMETER	DESCRIPTION	CONDITIONS	MIN	TYP	MAX	UNIT
AMP_{HIGH}	Amplitude Range High	$I_{IN} = 2\text{mA}$		100		mA_{P-P}
AMP_{LOW}	Amplitude Range Low	$I_{IN} = 300\mu\text{A}$		15		mA_{P-P}
I_{AVG}	Average Output Current @ 2.2V	$R_{FREQ} = 5210\Omega$		20		mA
I_{OUTP-P}	Output Current Tolerance	Defined as one standard deviation		2		%
Duty Cycle	Output Push Time/Cycle Time	$R_{FREQ} = 5210\Omega$		43		%
$PSRR_{AMP}$	Amplitude Change of Output $\Delta I/I$	V_{DD} from 4.5V to 5.5V		-54		dB
T_{ON}	Auto Turn-on Time	Input current step from 0mA to 1mA		15		us
T_{OFF}	Auto Turn-off Time	Input current step from 1mA to 0mA		0.5		us
IN_{OUT}	I_{OUT} Current Output Noise Density	$R_{FREQ} = 5490\Omega, F_{MEASURE} = 10\text{MHz}$		2.5		$\text{nA}/\sqrt{\text{Hz}}$

Typical Performance Curves (Continued)

$V_{DD} = 5V$, $T_A = 25^\circ C$, $R_L = 10\Omega$, $R_{FREQ} = 5.21k\Omega$, $I_{IN} = 1mA$, $V_{OUT} = 2.2V$ unless otherwise specified.

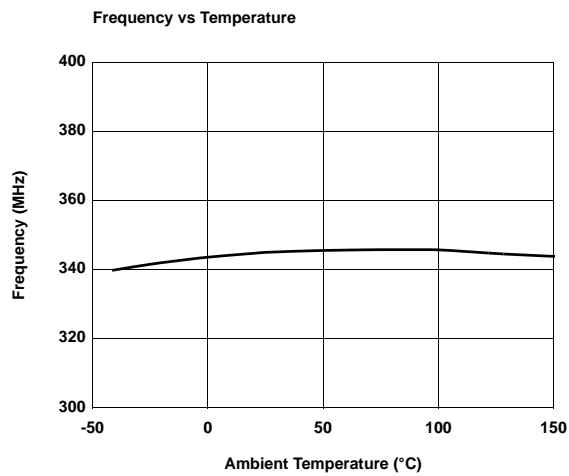
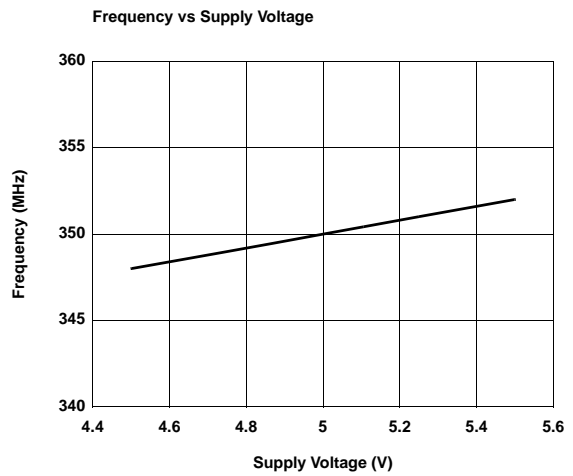
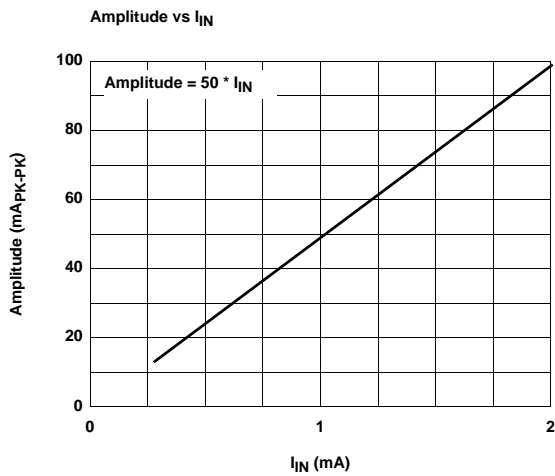
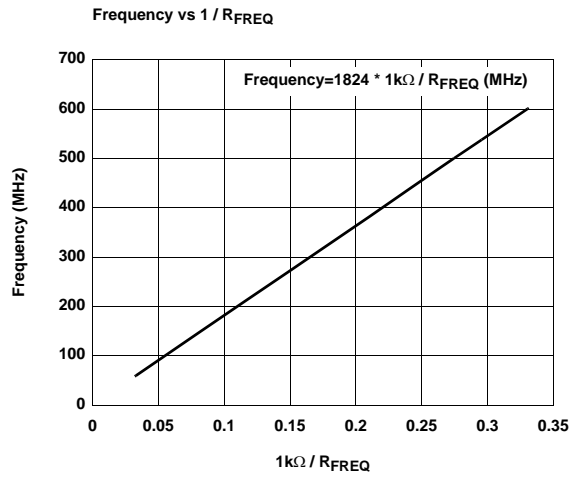
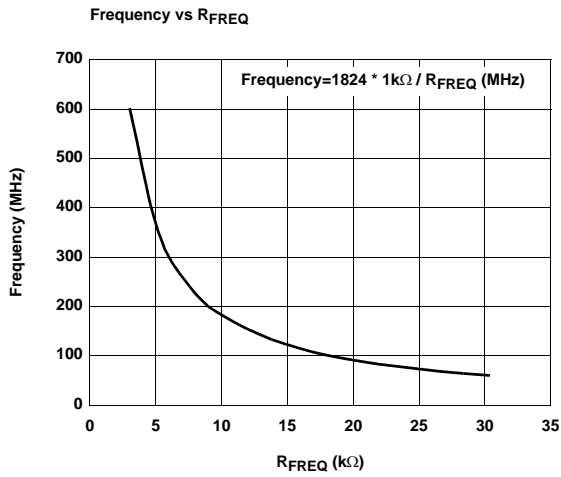

Block Diagram

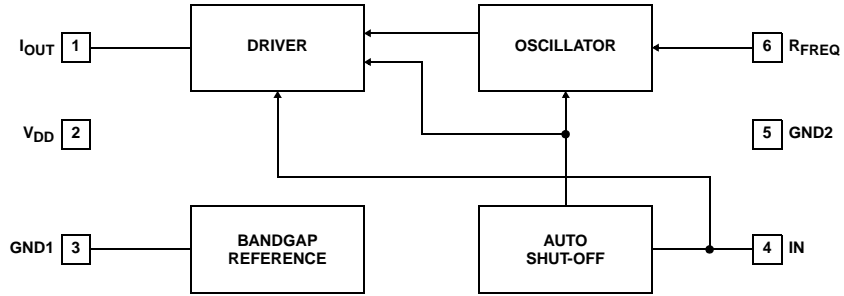

Typical Application Circuit

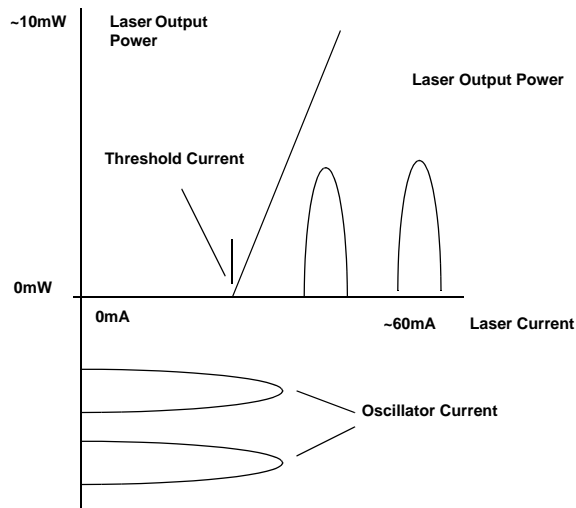
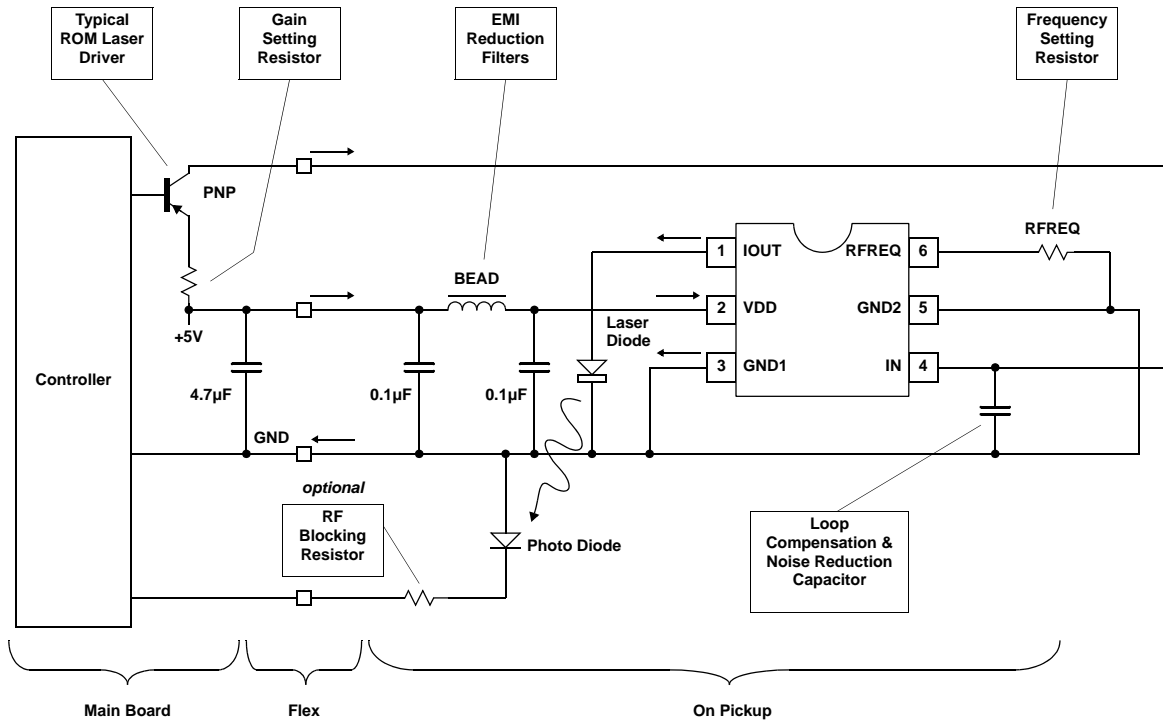

Applications Information

Product Description

The EL6205 is a solid state, low-power, high-speed laser modulation oscillator with external resistor-adjustable operating frequency. It is designed to interface easily to laser diodes to break up optical feedback resonant modes and thereby reduce laser noise. The output of the EL6205 is composed of a push current source switched at the oscillator frequency. The output and oscillator are automatically disabled for power saving when the average input current drops to less than 100 μ A. The EL6205 has the operating frequency from 60-600MHz and the output current from 10mA_{P-P} to 100mA_{P-P}. The supply current is only 30mA (includes laser current) for the output current of 50mA_{P-P} at the operating frequency of 350MHz.

Theory of Operation

A typical semiconductor laser will emit a small amount of incoherent light at low values of forward laser current. But after the threshold current is reached, the laser will emit coherent light. Further increases in the forward current will cause rapid increases in laser output power. A typical threshold current is 35mA and a typical slope efficiency is 0.7mW/mA.

When the laser is lasing, it will often change its mode of operation slightly, due to changes in current, temperature, or optical feedback into the laser. In a DVD-ROM, the optical feedback from the moving disk forms a significant noise factor due to feedback-induced mode hopping. In addition to the mode hopping noise, a diode laser will roughly have a constant noise level regardless of the power level when a threshold current is exceeded.

The oscillator is designed to produce a low noise oscillating current that is provided to the laser diode. The current is to cause the laser power to change at the oscillator frequency. This change causes the laser to go through rapid mode hopping. The low frequency component of laser power noise due to mode hopping is translated up to sidebands around the oscillator frequency by this action. Since the oscillator frequency can be filtered out of the low frequency read and serve channels, the net result is that the laser noise seems to be reduced. The second source of laser noise reduction is caused by the increase in the laser power above the average laser power during the pushing-current time. The signal-to-noise ratio (SNR) of the output power is better at higher laser powers because of the almost constant noise power when a threshold current is exceeded. In addition, when the laser is off during no output current time, the noise is also very low.

Setting the I_{IN} Current

By looking the typical application circuit, it can be seen that the push only oscillator is more efficient at the laser than the conventional push-pull oscillator. The significant current from the main board is reduced to be I_{IN} (≤ 2 mA), while the

oscillator takes on the role of supplying the total laser current.

The I_{IN} current is the previous read current (reduced in amplitude). Thus it does not need to be set, since it is within the control loop. The current capability of the external source for I_{IN} should be made large enough to power the worst, hottest old laser.

R_{FREQ} Pin Interfacing

Figure 1 shows an equivalent circuit of pins associated with the R_{FREQ} resistor. V_{REF} is roughly 1.27V. The resistor R_{FREQ} should be connected to the non-load side of the power ground to avoid noise. This resistor should also return to the EL6202's ground very directly to prevent noise pickup. They also should have minimal capacitance to ground. Trimmer resistors can be used to adjust initial operating points.

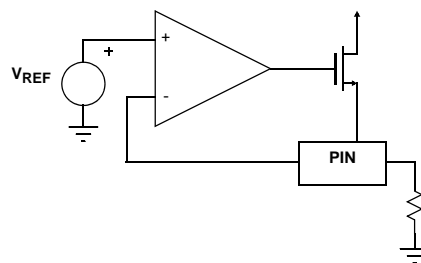

FIGURE 1. R_{FREQ} PIN INTERFACE

External voltage sources can be coupled to the R_{FREQ} pin to effect frequency modulation or adjustment. It is recommended that a coupling resistor of 1k be installed in series with the control voltage and mounted directly next to the pin. This will keep the inevitable high-frequency noise of the EL6205's local environment from propagating to the modulation source, and it will keep parasitic capacitance at the pin minimized.

Supply Bypassing and Grounding

The resistance of bypass-capacitors and the inductance of bonding wires prevent perfect bypass action, and 150mV_{P-P} noise on the power lines is common. There needs to be a lossy series bead inductance and secondary bypass on the supply side to control signals from propagating down the wires. Figure 2 shows the typical connection.

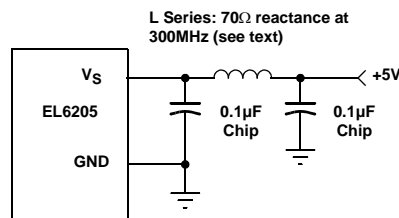

FIGURE 2. RECOMMENDED SUPPLY BYPASSING

Also important is circuit-board layout. At the EL6205's operating frequencies, even the ground plane is not low-impedance. High frequency current will create voltage drops in the ground plane. Figure 3 shows the output current loop.

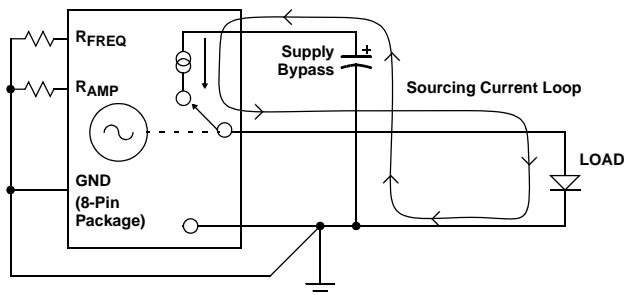

FIGURE 3. OUTPUT CURRENT LOOP

For the current loop, the current flows through the supply bypass-capacitor. The ground end of the bypass thus should be connected directly to the EL6205 ground pin and laser ground. A long ground return path will cause the bypass capacitor currents to generate voltage drops in the ground plane of the circuit board, and other components (such as R_FREQ) will pick this up as an interfering signal. Similarly, the ground return of the load should be considered, as noisy and other grounded components should not connect to this path. Slotting the ground plane around the load's return will reduce adjacent grounded components from seeing the noise.

Power Dissipation

It is important to calculate the maximum junction temperature for the application to determine if the conditions need to be modified for the oscillator to remain in the safe operating area.

The maximum power dissipation allowed in a package is determined according to:

$$P_{DMAX} = \frac{T_{JMAX} - T_{AMAX}}{\theta_{JA}}$$

where:

P_DMAX = Maximum power dissipation in the package

T_JMAX = Maximum junction temperature

T_AMAX = Maximum ambient temperature

θ_JA = Thermal resistance of the package

The supply current of the EL6205 depends on the peak-to-peak output current and the operating frequency which are determined by resistor R_FREQ. The supply current can be predicted approximately by the following equations:

$$I_{SUP1} = \frac{35mA \times 1k\Omega}{R_{FREQ}} + 0.5mA$$

$$I_{SUP2} = 50 \times I_{IN} \times 0.5$$

The power dissipation can be calculated from the following equation:

$$P_D = V_{SUP} \times I_{SUP1} + (V_{SUP} - V_{LAS}) \times I_{SUP2}$$

Here, V_SUP is the supply voltage and V_LAS is the average voltage of the laser diode. Figure 4 provides a convenient way to see if the device may overheat. The maximum safe power dissipation can be found graphically, based on the ambient temperature and JEDEC standard single layer PCB. For flex circuits, the θ_JA could be higher. By using the previous equation, it is possible to estimate if P_D exceeds the device's power derating curve. To ensure proper operation, it is important to observe the recommended derating curve shown in Figure 4.

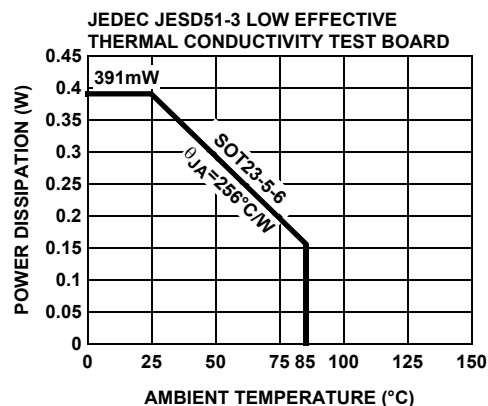
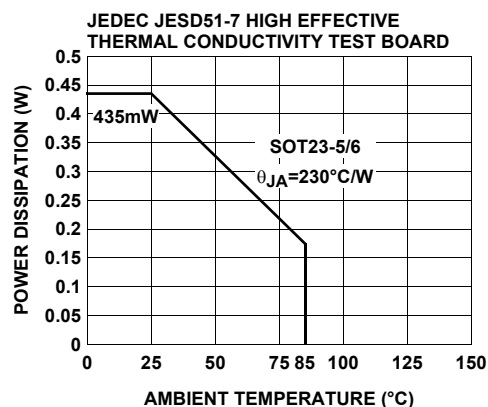

FIGURE 4. PACKAGE POWER DISSIPATION vs AMBIENT TEMPERATURE

All Intersil U.S. products are manufactured, assembled and tested utilizing ISO9000 quality systems.
Intersil Corporation's quality certifications can be viewed at www.intersil.com/design/quality

Intersil products are sold by description only. Intersil Corporation reserves the right to make changes in circuit design, software and/or specifications at any time without notice. Accordingly, the reader is cautioned to verify that data sheets are current before placing orders. Information furnished by Intersil is believed to be accurate and reliable. However, no responsibility is assumed by Intersil or its subsidiaries for its use; nor for any infringements of patents or other rights of third parties which may result from its use. No license is granted by implication or otherwise under any patent or patent rights of Intersil or its subsidiaries.

For information regarding Intersil Corporation and its products, see www.intersil.com