

EMC2DXV5T1, EMC3DXV5T1, EMC4DXV5T1, EMC5DXV5T1

Preferred Devices

Dual Common Base-Collector Bias Resistor Transistors

NPN and PNP Silicon Surface Mount Transistors with Monolithic Bias Resistor Network

The BRT (Bias Resistor Transistor) contains a single transistor with a monolithic bias network consisting of two resistors; a series base resistor and a base-emitter resistor. These digital transistors are designed to replace a single device and its external resistor bias network. The BRT eliminates these individual components by integrating them into a single device. In the EMC2DXV5T1 series, two complementary BRT devices are housed in the SOT-553 package which is ideal for low power surface mount applications where board space is at a premium.

Features

- Simplifies Circuit Design
- Reduces Board Space
- Reduces Component Count
- These are Pb-Free Devices

MAXIMUM RATINGS ($T_A = 25^\circ\text{C}$ unless otherwise noted, common for Q_1 and Q_2 , - minus sign for Q_1 (PNP) omitted)

Rating	Symbol	Value	Unit
Collector-Base Voltage	V_{CBO}	50	Vdc
Collector-Emitter Voltage	V_{CEO}	50	Vdc
Collector Current	I_C	100	mAdc

Maximum ratings are those values beyond which device damage can occur. Maximum ratings applied to the device are individual stress limit values (not normal operating conditions) and are not valid simultaneously. If these limits are exceeded, device functional operation is not implied, damage may occur and reliability may be affected.



ON Semiconductor®

<http://onsemi.com>

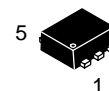
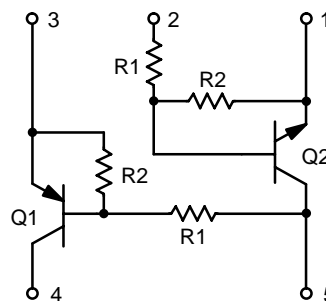

SOT-553
CASE 463B

MARKING DIAGRAM

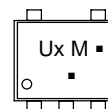

Ux = Specific Device Code
x = C, 3, E, or 5

M = Date Code

▪ = Pb-Free Package

(Note: Microdot may be in either location)

ORDERING INFORMATION

See detailed ordering and shipping information in the package dimensions section on page 2 of this data sheet.

Preferred devices are recommended choices for future use and best overall value.

EMC2DXV5T1, EMC3DXV5T1, EMC4DXV5T1, EMC5DXV5T1

THERMAL CHARACTERISTICS

Characteristic	Symbol	Max	Unit
ONE JUNCTION HEATED			
Total Device Dissipation $T_A = 25^\circ\text{C}$ Derate above 25°C	P_D	357 (Note 1) 2.9 (Note 1)	mW mW/ $^\circ\text{C}$
Thermal Resistance, Junction-to-Ambient	$R_{\theta JA}$	350 (Note 1)	$^\circ\text{C}/\text{W}$
BOTH JUNCTIONS HEATED			
Total Device Dissipation $T_A = 25^\circ\text{C}$ Derate above 25°C	P_D	500 (Note 1) 4.0 (Note 1)	mW mW/ $^\circ\text{C}$
Thermal Resistance, Junction-to-Ambient	$R_{\theta JA}$	250 (Note 1)	$^\circ\text{C}/\text{W}$
Junction and Storage Temperature	T_J, T_{stg}	-55 to +150	$^\circ\text{C}$

1. FR-4 @ Minimum Pad

DEVICE ORDERING INFORMATION, MARKING AND RESISTOR VALUES

Device	Marking	Transistor 1 – PNP		Transistor 2 – NPN		Package	Shipping [†]
		R1 (K)	R2 (K)	R1 (K)	R2 (K)		
EMC2DXV5T1	UC	22	22	22	22	SOT-553*	4000 / Tape & Reel
EMC2DXV5T1G						SOT-553*	
EMC2DXV5T5						SOT-553*	8000 / Tape & Reel
EMC2DXV5T5G						SOT-553*	
EMC3DXV5T1	U3	10	10	10	10	SOT-553*	4000 / Tape & Reel
EMC3DXV5T1G						SOT-553*	
EMC3DXV5T5						SOT-553*	8000 / Tape & Reel
EMC3DXV5T5G						SOT-553*	
EMC4DXV5T1	UE	10	47	47	47	SOT-553*	4000 / Tape & Reel
EMC4DXV5T1G						SOT-553*	
EMC4DXV5T5						SOT-553*	8000 / Tape & Reel
EMC4DXV5T5G						SOT-553*	
EMC5DXV5T1	U5	4.7	10	47	47	SOT-553*	4000 / Tape & Reel
EMC5DXV5T1G						SOT-553*	
EMC5DXV5T5						SOT-553*	8000 / Tape & Reel
EMC5DXV5T5G						SOT-553*	

[†]For information on tape and reel specifications, including part orientation and tape sizes, please refer to our Tape and Reel Packaging Specifications Brochure, BRD8011/D.

*This package is inherently Pb-Free.

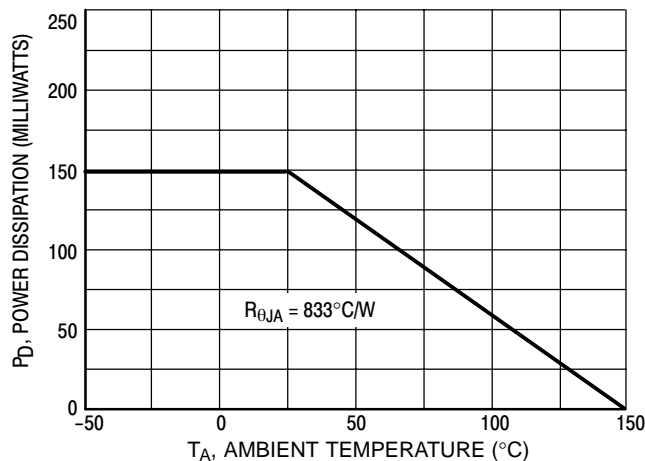

Figure 1. Derating Curve

EMC2DXV5T1, EMC3DXV5T1, EMC4DXV5T1, EMC5DXV5T1

ELECTRICAL CHARACTERISTICS (T_A = 25°C unless otherwise noted)

Characteristic	Symbol	Min	Typ	Max	Unit
Q1 TRANSISTOR: PNP OFF CHARACTERISTICS					
Collector-Base Cutoff Current (V _{CB} = 50 V, I _E = 0)	I _{CBO}	–	–	100	nAdc
Collector-Emitter Cutoff Current (V _{CB} = 50 V, I _B = 0)	I _{CEO}	–	–	500	nAdc
Emitter-Base Cutoff Current (V _{EB} = 6.0, I _C = 5.0 mA)	I _{EBO}	–	–	0.2	mAdc
	EMC2DXV5T1	–	–	0.5	
	EMC3DXV5T1	–	–	0.2	
	EMC4DXV5T1	–	–	1.0	
	EMC5DXV5T1	–	–		

ON CHARACTERISTICS

Collector-Base Breakdown Voltage (I _C = 10 μA, I _E = 0)	V _{(BR)CBO}	50	–	–	Vdc
Collector-Emitter Breakdown Voltage (I _C = 2.0 mA, I _B = 0)	V _{(BR)CEO}	50	–	–	Vdc
DC Current Gain (V _{CE} = 10 V, I _C = 5.0 mA)	h _{FE}	60	100	–	
	EMC2DXV5T1	35	60	–	
	EMC3DXV5T1	80	140	–	
	EMC4DXV5T1	20	35	–	
	EMC5DXV5T1				
Collector-Emitter Saturation Voltage (I _C = 10 mA, I _B = 0.3 mA)	V _{CE(SAT)}	–	–	0.25	Vdc
Output Voltage (on) (V _{CC} = 5.0 V, V _B = 2.5 V, R _L = 1.0 kΩ)	V _{OL}	–	–	0.2	Vdc
Output Voltage (off) (V _{CC} = 5.0 V, V _B = 0.5 V, R _L = 1.0 kΩ)	V _{OH}	4.9	–	–	Vdc
Input Resistor	R1	15.4	22	28.6	kΩ
	EMC2DXV5T1	7.0	10	13	
	EMC3DXV5T1, EMC4DXV5T1	3.3	4.7	6.1	
	EMC5DXV5T1				
Resistor Ratio	R1/R2	0.8	1.0	1.2	
	EMC2DXV5T1	0.8	1.0	1.2	
	EMC3DXV5T1	0.17	0.21	0.25	
	EMC4DXV5T1	0.38	0.47	0.56	
	EMC5DXV5T1				

Q2 TRANSISTOR: NPN OFF CHARACTERISTICS

Collector-Base Cutoff Current (V _{CB} = 50 V, I _E = 0)	I _{CBO}	–	–	100	nAdc
Collector-Emitter Cutoff Current (V _{CB} = 50 V, I _B = 0)	I _{CEO}	–	–	500	nAdc
Emitter-Base Cutoff Current (V _{EB} = 6.0, I _C = 5.0 mA)	I _{EBO}	–	–	0.2	mAdc
	EMC2DXV5T1	–	–	0.5	
	EMC3DXV5T1	–	–	0.1	
	EMC4DXV5T1, EMC5DXV5T1	–	–		

ON CHARACTERISTICS

Collector-Base Breakdown Voltage (I _C = 10 μA, I _E = 0)	V _{(BR)CBO}	50	–	–	Vdc
Collector-Emitter Breakdown Voltage (I _C = 2.0 mA, I _B = 0)	V _{(BR)CEO}	50	–	–	Vdc
DC Current Gain (V _{CE} = 10 V, I _C = 5.0 mA)	h _{FE}	60	100	–	
	EMC2DXV5T1	35	60	–	
	EMC3DXV5T1	80	140	–	
	EMC4DXV5T1, EMC5DXV5T1				
Collector-Emitter Saturation Voltage (I _C = 10 mA, I _B = 0.3 mA)	V _{CE(SAT)}	–	–	0.25	Vdc
Output Voltage (on) (V _{CC} = 5.0 V, V _B = 2.5 V, R _L = 1.0 kΩ)	V _{OL}	–	–	0.2	Vdc
Output Voltage (off) (V _{CC} = 5.0 V, V _B = 0.5 V, R _L = 1.0 kΩ)	V _{OH}	4.9	–	–	Vdc
Input Resistor	R1	15.4	22	28.6	kΩ
	EMC2DXV5T1	7.0	10	13	
	EMC3DXV5T1	33	47	61	
	EMC4DXV5T1, EMC5DXV5T1				
Resistor Ratio	R1/R2	0.8	1.0	1.2	
	EMC2DXV5T1	0.8	1.0	1.2	
	EMC3DXV5T1	0.8	1.0	1.2	
	EMC4DXV5T1, EMC5DXV5T1	0.8	1.0	1.2	

EMC2DXV5T1, EMC3DXV5T1, EMC4DXV5T1, EMC5DXV5T1

TYPICAL ELECTRICAL CHARACTERISTICS – EMC2DXV5T1 PNP TRANSISTOR

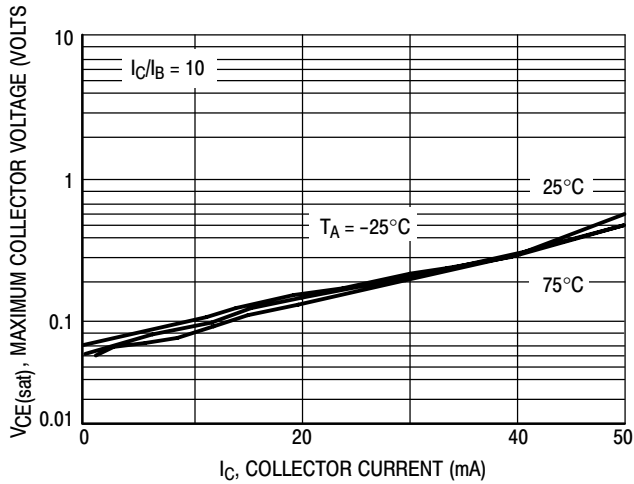

Figure 2. $V_{CE(sat)}$ versus I_C

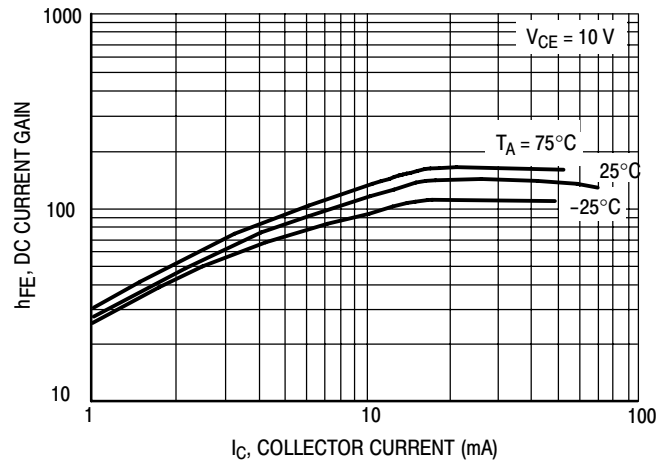

Figure 3. DC Current Gain

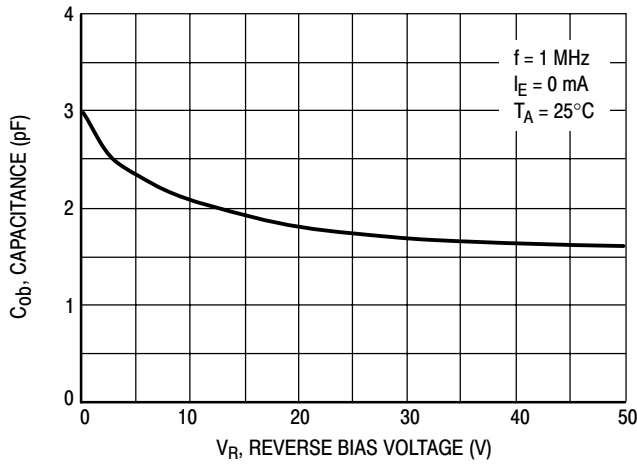

Figure 4. Output Capacitance

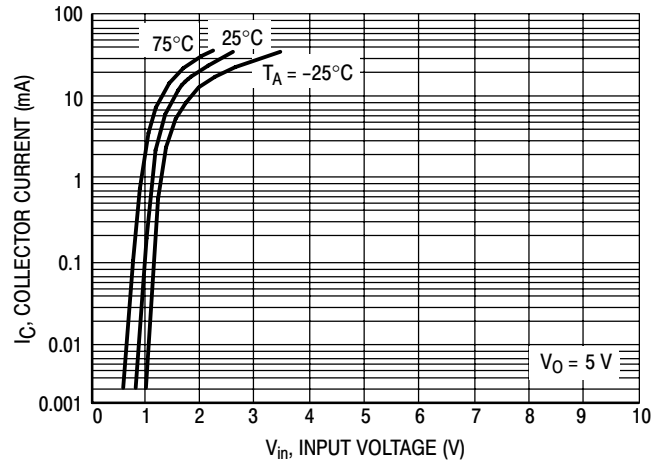

Figure 5. Output Current versus Input Voltage

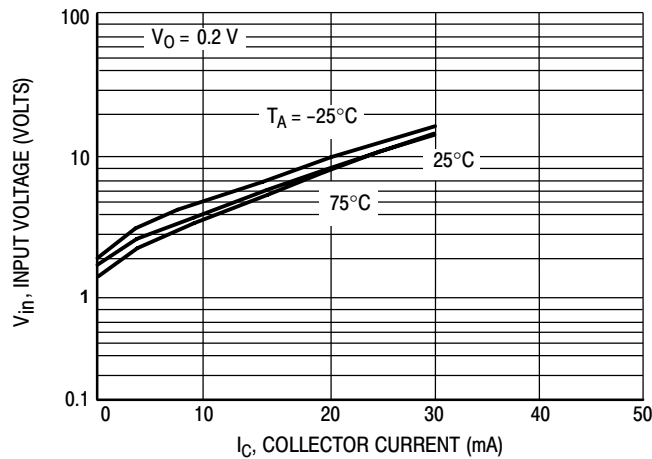

Figure 6. Input Voltage versus Output Current

EMC2DXV5T1, EMC3DXV5T1, EMC4DXV5T1, EMC5DXV5T1

TYPICAL ELECTRICAL CHARACTERISTICS – EMC2DXV5T1 NPN TRANSISTOR

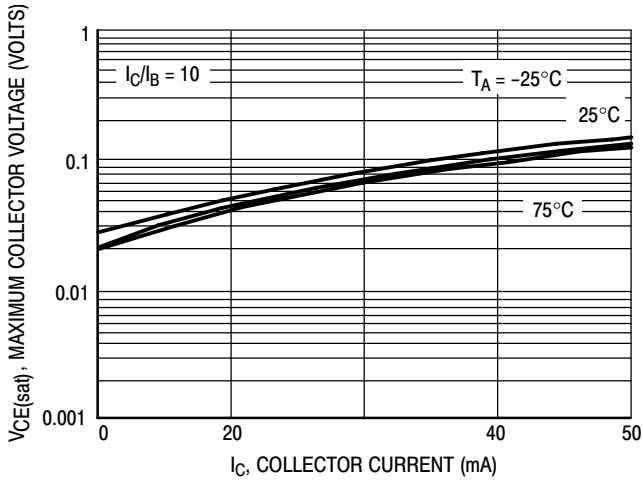

Figure 7. $V_{CE(sat)}$ versus I_C

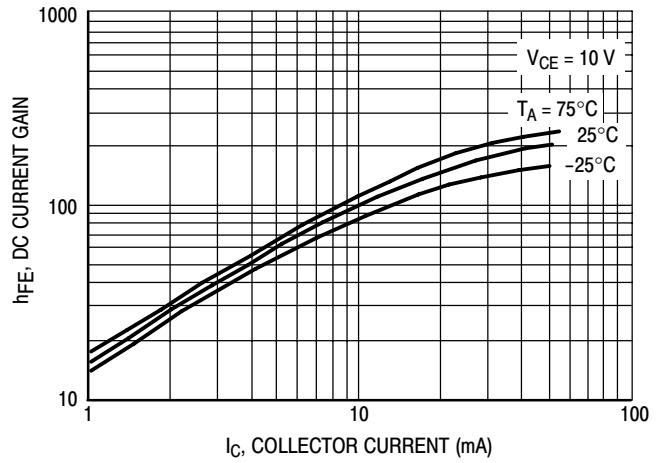

Figure 8. DC Current Gain

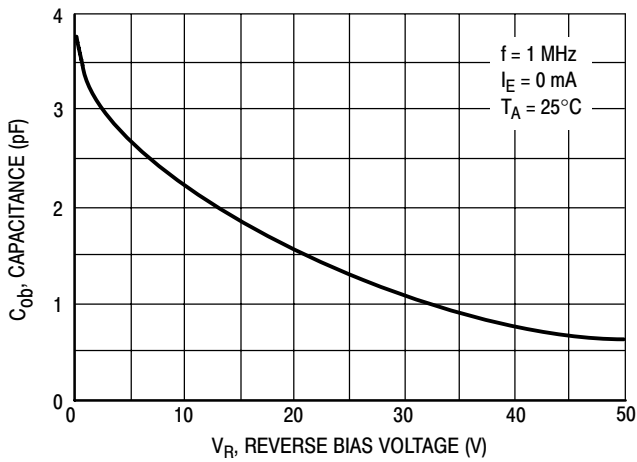

Figure 9. Output Capacitance

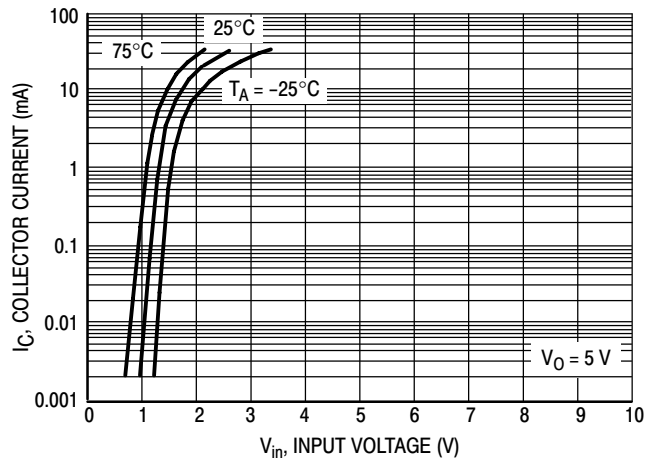

Figure 10. Output Current versus Input Voltage

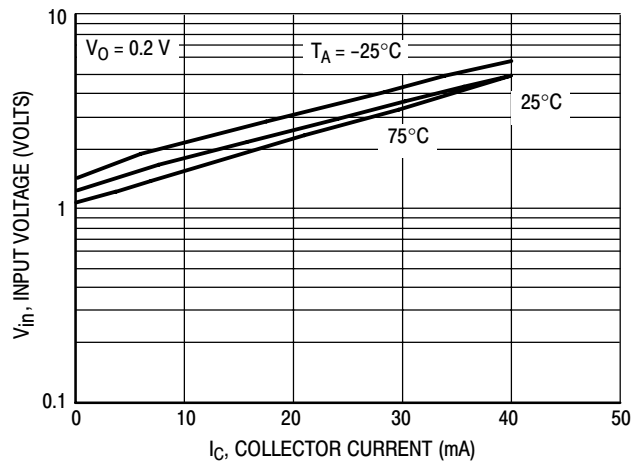

Figure 11. Input Voltage versus Output Current

EMC2DXV5T1, EMC3DXV5T1, EMC4DXV5T1, EMC5DXV5T1

TYPICAL ELECTRICAL CHARACTERISTICS – EMC3DXV5T1 PNP TRANSISTOR

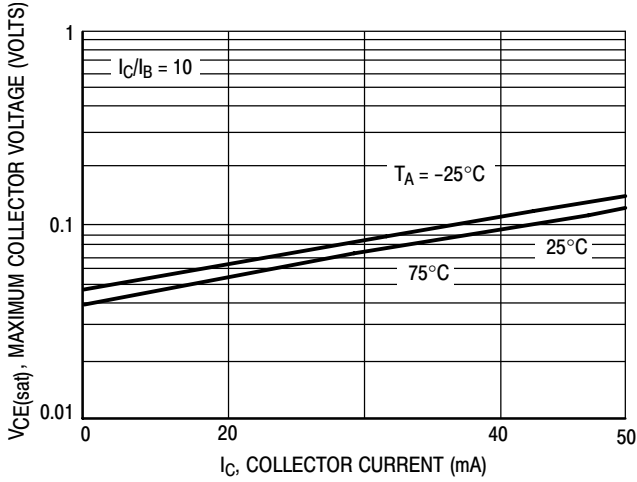

Figure 12. $V_{CE(sat)}$ versus I_C

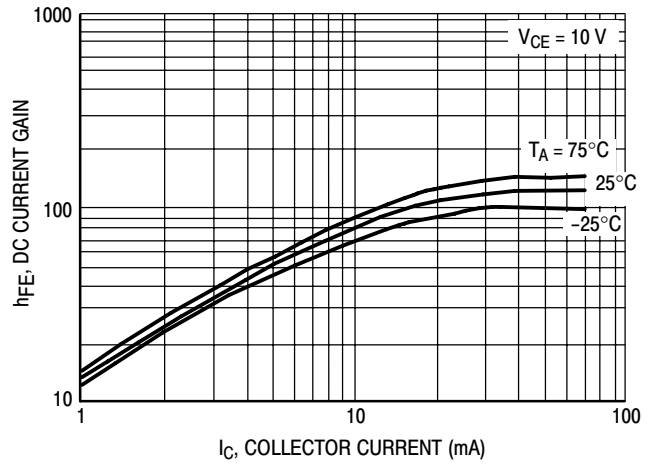

Figure 13. DC Current Gain

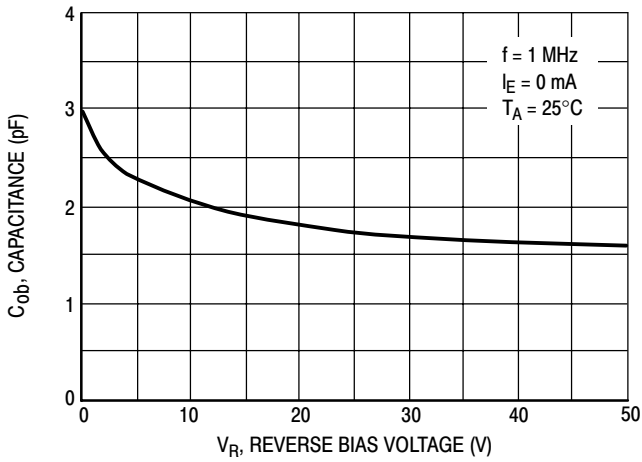

Figure 14. Output Capacitance

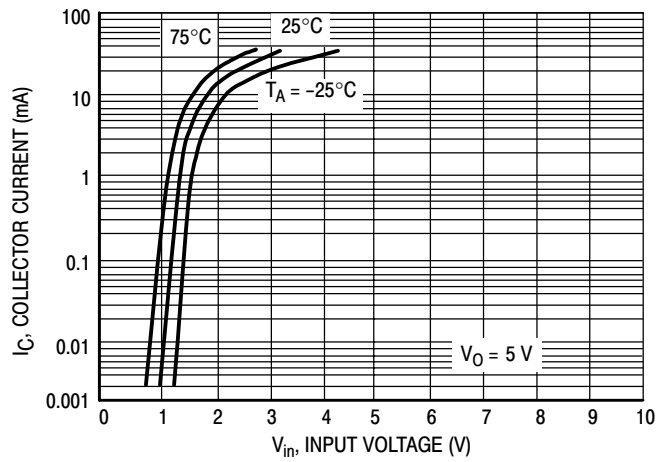

Figure 15. Output Current versus Input Voltage

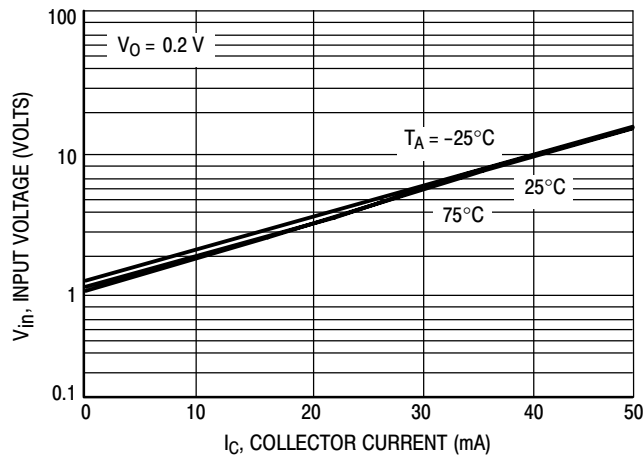

Figure 16. Input Voltage versus Output Current

EMC2DXV5T1, EMC3DXV5T1, EMC4DXV5T1, EMC5DXV5T1

TYPICAL ELECTRICAL CHARACTERISTICS – EMC3DXV5T1 NPN TRANSISTOR

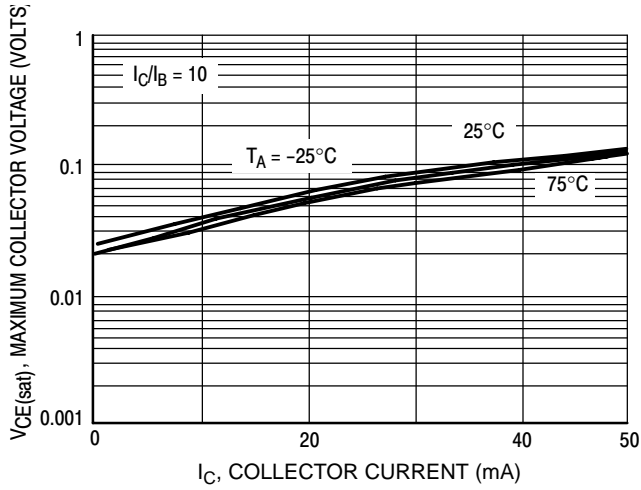

Figure 17. $V_{CE(sat)}$ versus I_C

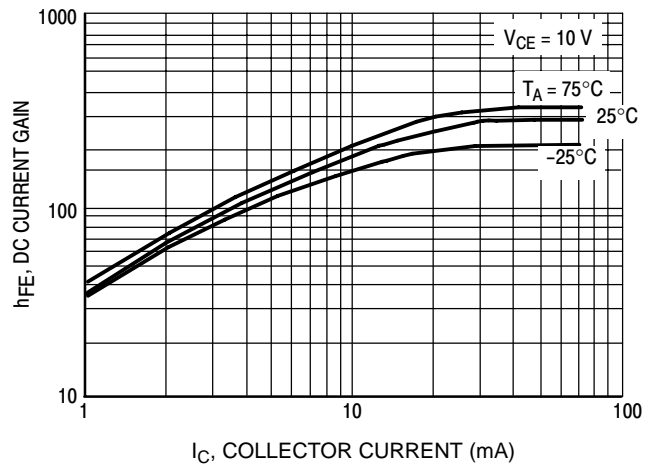

Figure 18. DC Current Gain

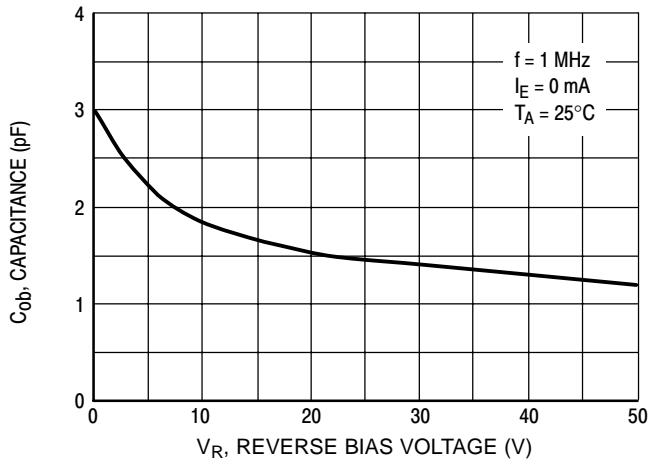

Figure 19. Output Capacitance

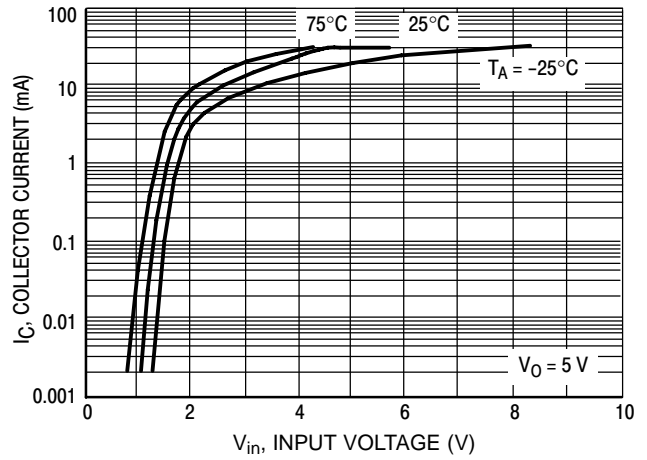

Figure 20. Output Current versus Input Voltage

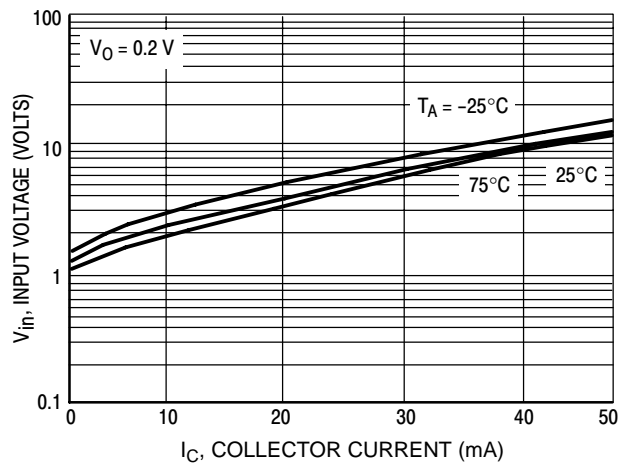

Figure 21. Input Voltage versus Output Current

EMC2DXV5T1, EMC3DXV5T1, EMC4DXV5T1, EMC5DXV5T1

TYPICAL ELECTRICAL CHARACTERISTICS – EMC4DXV5T1 PNP TRANSISTOR

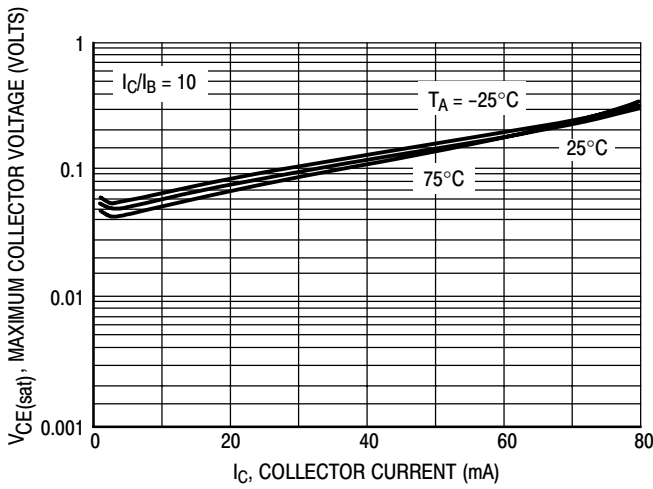

Figure 22. $V_{CE(sat)}$ versus I_C

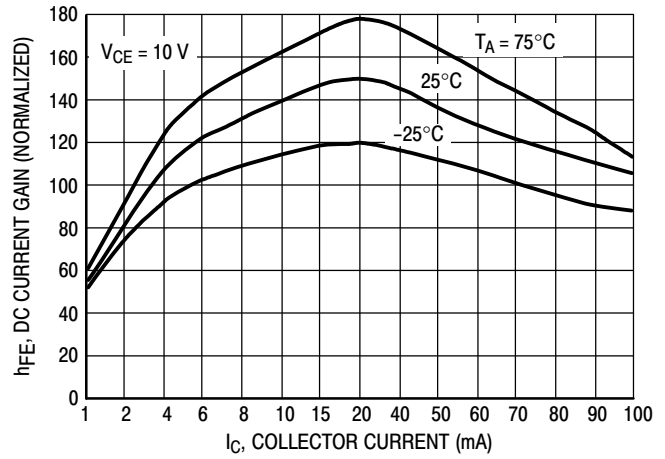

Figure 23. DC Current Gain

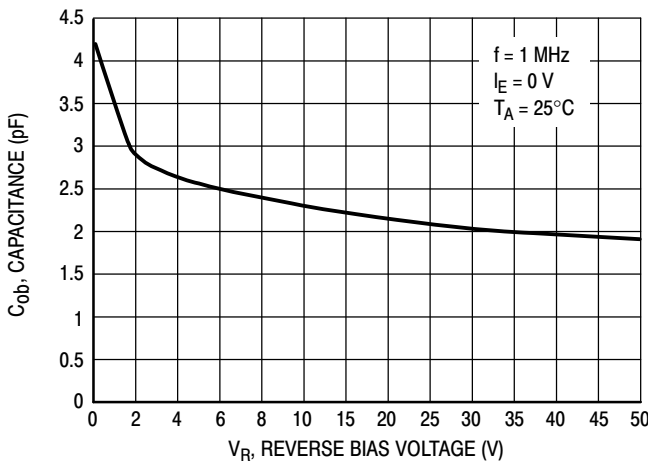

Figure 24. Output Capacitance

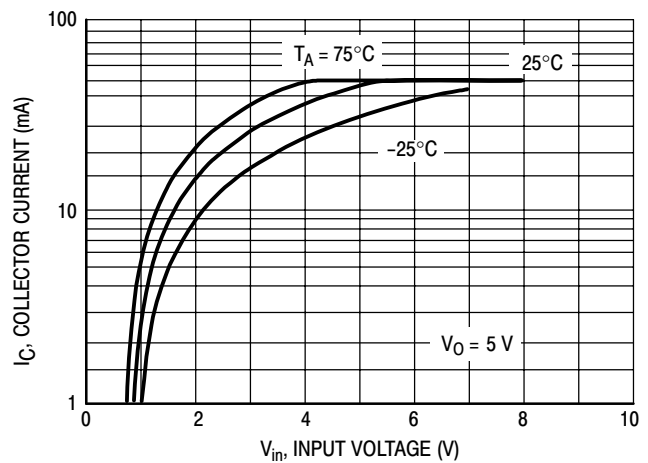

Figure 25. Output Current versus Input Voltage

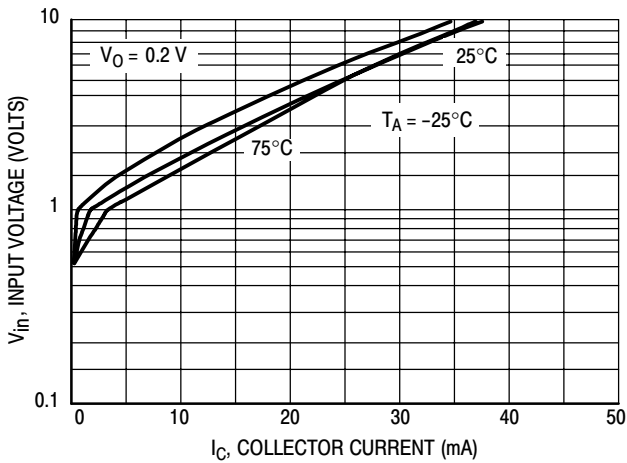

Figure 26. Input Voltage versus Output Current

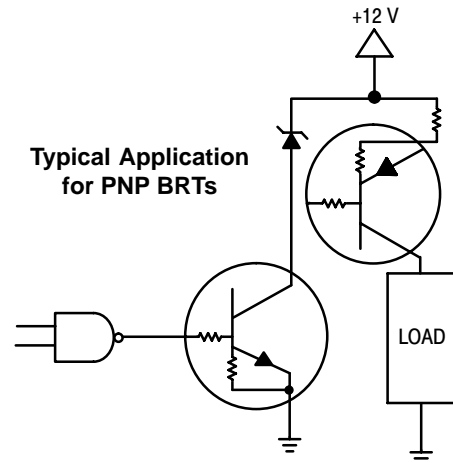

Figure 27. Inexpensive, Unregulated Current Source

EMC2DXV5T1, EMC3DXV5T1, EMC4DXV5T1, EMC5DXV5T1

TYPICAL ELECTRICAL CHARACTERISTICS – EMC5DXV5T1 PNP TRANSISTOR

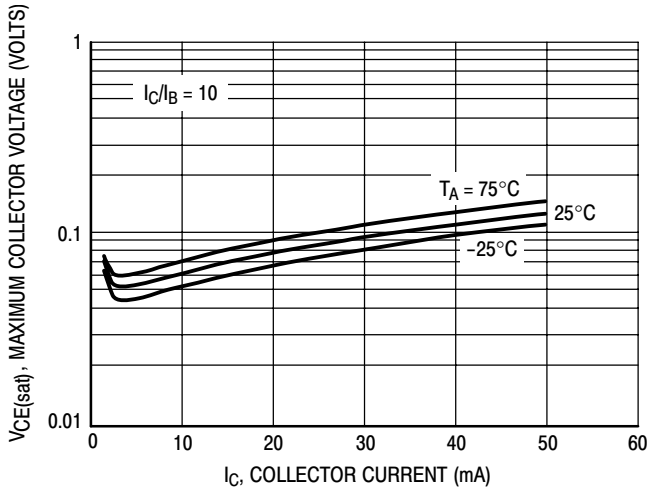

Figure 28. $V_{CE(sat)}$ versus I_C

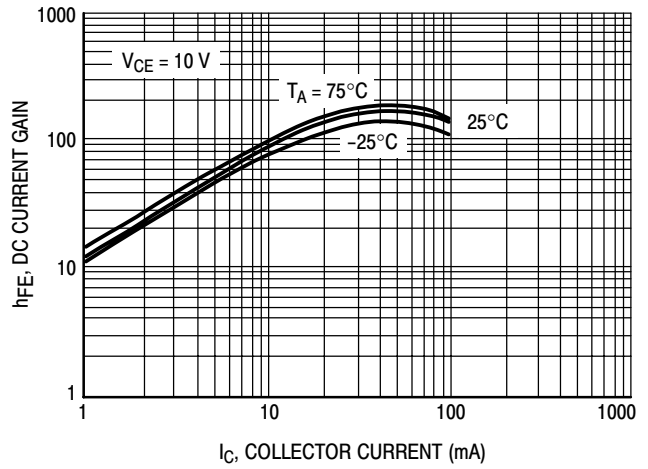

Figure 29. DC Current Gain

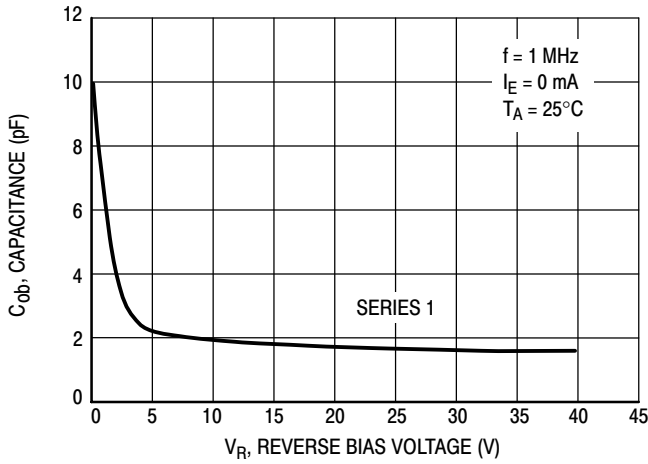

Figure 30. Output Capacitance

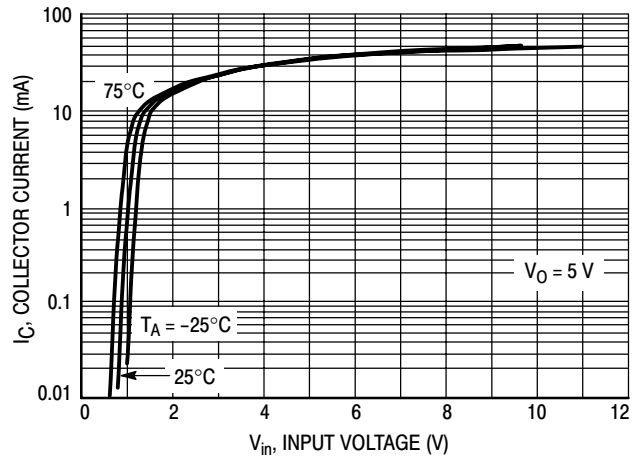

Figure 31. Output Current versus Input Voltage

EMC2DXV5T1, EMC3DXV5T1, EMC4DXV5T1, EMC5DXV5T1

TYPICAL ELECTRICAL CHARACTERISTICS – EMC4DXV5T1, EMC5DXV5T1 NPN TRANSISTOR

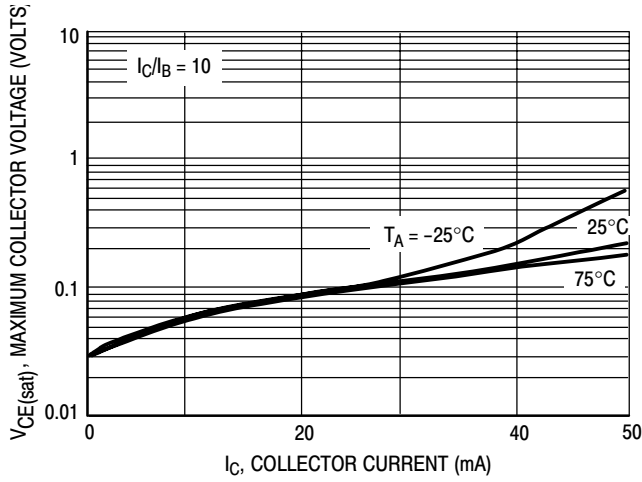

Figure 32. $V_{CE(sat)}$ versus I_C

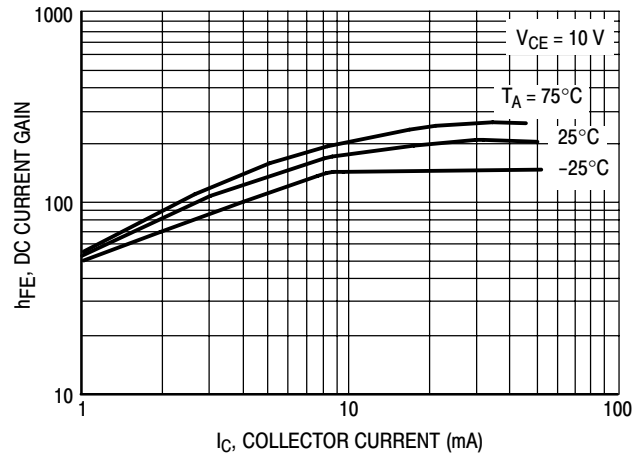

Figure 33. DC Current Gain

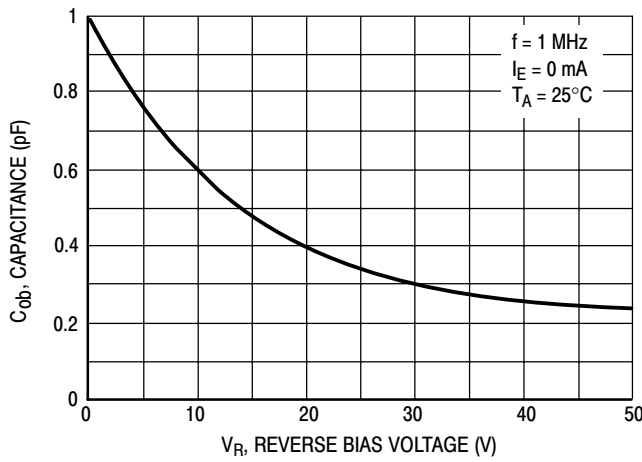

Figure 34. Output Capacitance

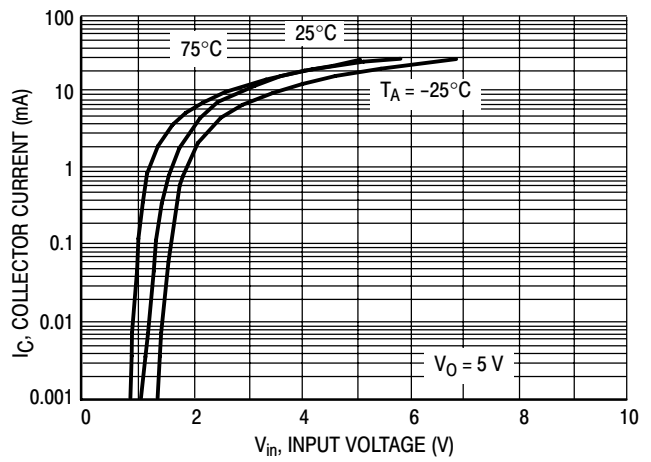

Figure 35. Output Current versus Input Voltage

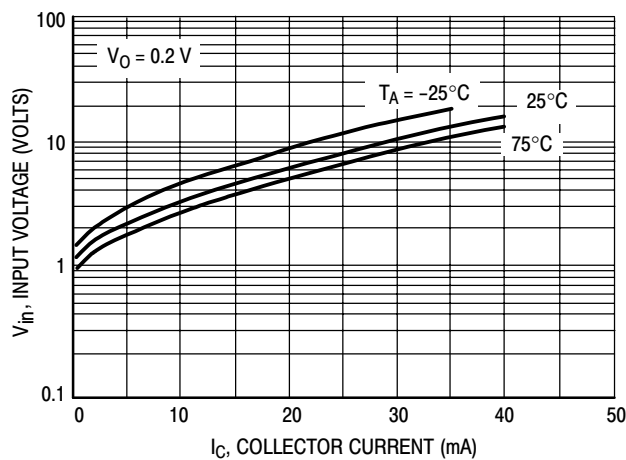
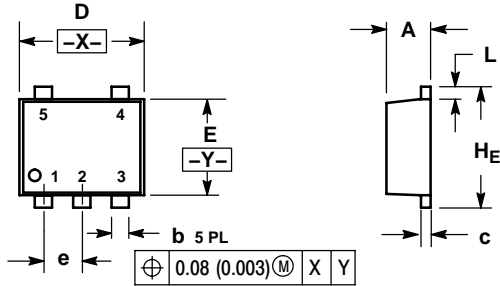

Figure 36. Input Voltage versus Output Current

EMC2DXV5T1, EMC3DXV5T1, EMC4DXV5T1, EMC5DXV5T1

PACKAGE DIMENSIONS

SOT-553
XV5 SUFFIX
CASE 463B-01
ISSUE B



NOTES:

1. DIMENSIONING AND TOLERANCING PER ANSI Y14.5M, 1982.
2. CONTROLLING DIMENSION: MILLIMETERS
3. MAXIMUM LEAD THICKNESS INCLUDES LEAD FINISH THICKNESS. MINIMUM LEAD THICKNESS IS THE MINIMUM THICKNESS OF BASE MATERIAL.

DIM	MILLIMETERS			INCHES		
	MIN	NOM	MAX	MIN	NOM	MAX
A	0.50	0.55	0.60	0.020	0.022	0.024
b	0.17	0.22	0.27	0.007	0.009	0.011
c	0.08	0.13	0.18	0.003	0.005	0.007
D	1.50	1.60	1.70	0.059	0.063	0.067
E	1.10	1.20	1.30	0.043	0.047	0.051
e	0.50 BSC			0.020 BSC		
L	0.10	0.20	0.30	0.004	0.008	0.012
HE	1.50	1.60	1.70	0.059	0.063	0.067

SOLDERING FOOTPRINT*

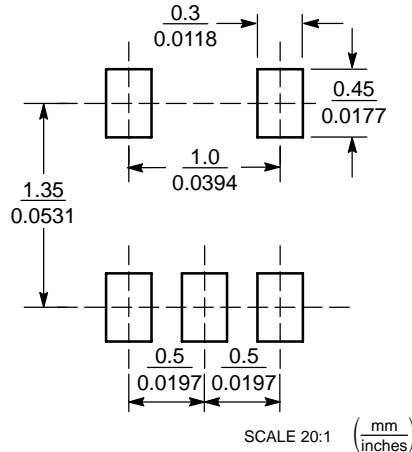

*For additional information on our Pb-Free strategy and soldering details, please download the ON Semiconductor Soldering and Mounting Techniques Reference Manual, SOLDERRM/D.

ON Semiconductor and are registered trademarks of Semiconductor Components Industries, LLC (SCILLC). SCILLC reserves the right to make changes without further notice to any products herein. SCILLC makes no warranty, representation or guarantee regarding the suitability of its products for any particular purpose, nor does SCILLC assume any liability arising out of the application or use of any product or circuit, and specifically disclaims any and all liability, including without limitation special, consequential or incidental damages. "Typical" parameters which may be provided in SCILLC data sheets and/or specifications can and do vary in different applications and actual performance may vary over time. All operating parameters, including "Typicals" must be validated for each customer application by customer's technical experts. SCILLC does not convey any license under its patent rights nor the rights of others. SCILLC products are not designed, intended, or authorized for use as components in systems intended for surgical implant into the body, or other applications intended to support or sustain life, or for any other application in which the failure of the SCILLC product could create a situation where personal injury or death may occur. Should Buyer purchase or use SCILLC products for any such unintended or unauthorized application, Buyer shall indemnify and hold SCILLC and its officers, employees, subsidiaries, affiliates, and distributors harmless against all claims, costs, damages, and expenses, and reasonable attorney fees arising out of, directly or indirectly, any claim of personal injury or death associated with such unintended or unauthorized use, even if such claim alleges that SCILLC was negligent regarding the design or manufacture of the part. SCILLC is an Equal Opportunity/Affirmative Action Employer. This literature is subject to all applicable copyright laws and is not for resale in any manner.

PUBLICATION ORDERING INFORMATION

LITERATURE FULFILLMENT:
Literature Distribution Center for ON Semiconductor
P.O. Box 61312, Phoenix, Arizona 85082-1312 USA
Phone: 480-829-7710 or 800-344-3860 Toll Free USA/Canada
Fax: 480-829-7709 or 800-344-3867 Toll Free USA/Canada
Email: orderlit@onsemi.com

N. American Technical Support: 800-282-9855 Toll Free
USA/Canada

Japan: ON Semiconductor, Japan Customer Focus Center
2-9-1 Kamimeguro, Meguro-ku, Tokyo, Japan 153-0051
Phone: 81-3-5773-3850

ON Semiconductor Website: <http://onsemi.com>

Order Literature: <http://www.onsemi.com/litorder>

For additional information, please contact your local Sales Representative.