



# Chokes





## Contents AC Power Line Chokes

PCA Part No.	OCL Range (mH)	Current Range (Arms)	Length	Width	Height
EPZ3032 Series	.047 – 2.2	.016 – .430	.840	.740	.670
EPZ3033 Series	2.7 – 1.20	.468 – 16	1.07	.860	.830
EPZ3037V Series	.82 – 33	.3 – 2.0	.827	.630	.846
EPZ3040V Series	1.5 – 82	.8 – 5.0	1.417	1.004	1.535
EPZ3041V Series	2.2 – 6.8	.6 – 3.0	1.412	.827	1.358
EPZ3042V Series	.15 – .82	.8 – 10	1.457	.945	1.634
EPZ3043H Series	1.0 – 6.8	.25 – 2.1	.787	.827	.787
EPZ3044V Series	1.8 – 33	.3 – 1.5	.827	.827	.650
EPZ3045V Series	.56 – 68	.4 – 3.4	.945	.984	.768
EPZ3046H Series	1.0 – 68	.5 – 3.4	1.122	1.142	.886
EPZ3047F Series	1.0 – 50	.3 – 2.2	.945	.906	.551
EPZ3048F Series	1.3 – 50	.4 – 2.5	1.102	.984	.591
EPZ3049M Series	.5 – 30	.1 – 1.0	.630	.413	.630
EPZ3050M Series	.5 – 30	.1 – 1.0	.630	.571	.453
EPZ3052N Series	.6 – 1.04	.2 – 3.0	.894	.591	.846
EPZ3053N Series	1.4 – 80	.4 – 32.	1.083	.709	1.043
EPZ3054N Series	1.5 – 69	.6 – 4.0	1.260	.787	1.142
EPZ3055HN Series	.8 – 142	.2 – .30	.894	.591	.846
EPZ3056HN Series	1.7 – 99	.4 – 3.2	1.083	.709	1.043
EPZ3057HN Series	1.9 – 87	.6 – 4.0	1.260	.787	1.142
EPZ3058 Series	.9 – 27	.4 – 2.0	.748	.669	.866
EPZ3059 Series	.54 – 9.0	.5 – 2.0	.748	.669	.866
EPZ3060LP Series	1.5 – 43	.3 – 3.0	.709	.630	.689
EPZ3061LP Series	.9 – 36	.3 – 2.0	.709	.630	.689
EPZ3064 Series	.019 – .666	0.8 – 4.8	1.250	1.200	.750
EPZ30651M Series	.5 – 28	.2 – 2.0	.709	.591	.787

# Power Choke EPZ3032-X

- Used in Power AC Line Filters, AC-AC Converters and Switching Power Supplies
- UL 94V-0 Recognized Components
- UL 1446 Class B Insulation System
- Meets or exceeds CSA/IEC/VDE/UL Specifications for Creepage, Clearance and Dielectric Strength
- 50 Hz - 500 Hz Switching Frequency
- 3750 Vrms Isolation
- In EE25 Standard Package

### Electrical Parameters @ 25° C

Part Number	Inductance (mH ± 25%) @ 1 KHz	DCR (Ω Max.)	Current Rating (Amperes Max.)	Temperature Rise (°C Max.) @ Max. Current
EPZ3032-470	.047	.016	3.5	13
EPZ3032-560	.056	.018	3.5	15
EPZ3032-680	.068	.019	3.5	15
EPZ3032-820	.082	.023	2.8	12
EPZ3032-101	.100	.025	2.8	13
EPZ3032-121	.120	.028	2.8	15
EPZ3032-151	.150	.030	2.8	16
EPZ3032-181	.180	.038	2.2	12
EPZ3032-221	.220	.044	2.2	14
EPZ3032-271	.270	.049	2.2	16
EPZ3032-331	.330	.058	1.7	11
EPZ3033-471	.470	.076	1.4	10
EPZ3032-561	.560	.090	1.4	12
EPZ3032-681	.680	.114	1.1	9
EPZ3032-821	.820	.130	1.1	10
EPZ3032-102	1.00	.194	.88	10
EPZ3032-122	1.20	.218	.88	11
EPZ3032-152	1.50	.278	.70	9
EPZ3032-182	1.80	.306	.70	10
EPZ3032-222	2.20	.430	.55	9

### Package

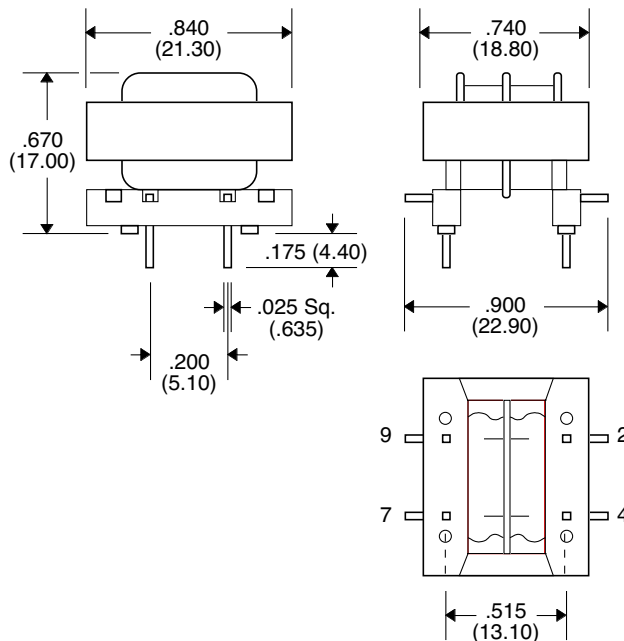

### Schematic



Unless Otherwise Specified Dimensions are in Inches /mm ± .010 / .25

# Power Choke

## EPZ3032-X

- Used in Power AC Line Filters, AC-AC Converters and Switching Power Supplies
- UL 94V-0 Recognized Components
- UL 1446 Class B Insulation System
- Meets or exceeds CSA/IEC/VDE/UL Specifications for Creepage, Clearance and Dielectric Strength
- 50 Hz - 500 Hz Switching Frequency
- 3750 Vrms Isolation
- In EE25 Standard Package

### Electrical Parameters @ 25° C

Part Number	Inductance (mH ± 25%) @ 1 KHz	DCR (Ω Max.)	Current Rating (Amperes Max.)	Temperature Rise (°C Max.) @ Max. Current
EPZ3032-272	2.7	.468	.55	10
EPZ3032-332	3.3	.530	.55	11
EPZ3032-392	3.9	.668	.44	9
EPZ3032-472	4.7	.760	.44	10
EPZ3032-562	5.6	.852	.44	11
EPZ3032-682	6.8	1.24	.35	10
EPZ3032-822	8.2	1.40	.35	11
EPZ3032-103	10	1.60	.35	13
EPZ3032-123	12	1.98	.27	10
EPZ3032-153	15	2.24	.27	11
EPZ3032-183	18	2.45	.27	12
EPZ3032-223	22	3.49	.22	11
EPZ3032-273	27	4.60	.17	9
EPZ3032-333	33	5.20	.17	10
EPZ3032-393	39	7.19	.13	8
EPZ3032-473	47	7.80	.13	9
EPZ3032-563	56	8.69	.13	10
EPZ3032-683	68	9.69	.13	11
EPZ3032-104	82	13.10	.10	9
EPZ3032-124	100	14.60	.10	10
EPZ3032-222	120	16.00	.10	11

### Package

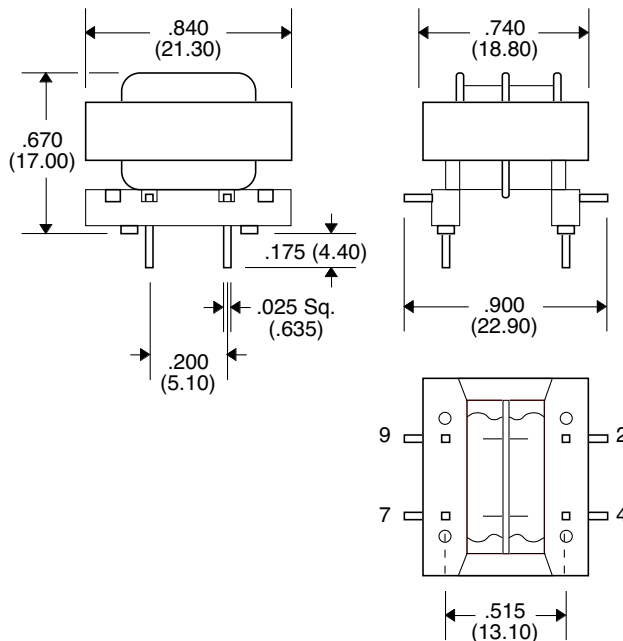

### Schematic



Unless Otherwise Specified Dimensions are in Inches /mm ± .010 / .25

# Power Choke EPZ3033-X

- Used in Power AC Line Filters, AC-AC Converters and Switching Power Supplies
- UL 94V-0 Recognized Components
- UL 1446 Class B Insulation System
- Meets or exceeds CSA/IEC/VDE/UL Specifications for Creepage, Clearance and Dielectric Strength
- 50 Hz - 500 Hz Switching Frequency
- 3750 Vrms Isolation
- In EE25 Standard Package

### Electrical Parameters @ 25° C

Part Number	Inductance (mH ± 25%) @ 1 KHz	DCR (Ω Max.)	Current Rating (Amperes Max.)	Temperature Rise (°C Max.) @ Max. Current
EPZ3033-560	.056	.013	5.5	18
EPZ3033-680	.068	.013	5.5	18
EPZ3033-820	.082	.013	5.5	18
EPZ3033-101	.100	.013	5.5	18
EPZ3033-121	.120	.015	5.5	21
EPZ3033-151	.150	.015	5.5	21
EPZ3033-181	.180	.019	4.5	17
EPZ3033-221	.220	.020	4.5	18
EPZ3033-271	.270	.025	4.5	23
EPZ3033-331	.330	.025	3.5	14
EPZ3033-471	.470	.030	3.5	17
EPZ3033-561	.560	.035	3.5	19
EPZ3033-681	.680	.040	3.5	22
EPZ3033-821	.820	.060	2.8	21
EPZ3033-102	1.00	.065	2.8	23
EPZ3033-122	1.20	.095	2.2	21
EPZ3033-152	1.50	.115	1.7	15
EPZ3033-182	1.80	.125	1.7	16
EPZ3033-222	2.20	.170	1.4	15
EPZ3033-272	2.70	.180	1.4	16

### Package

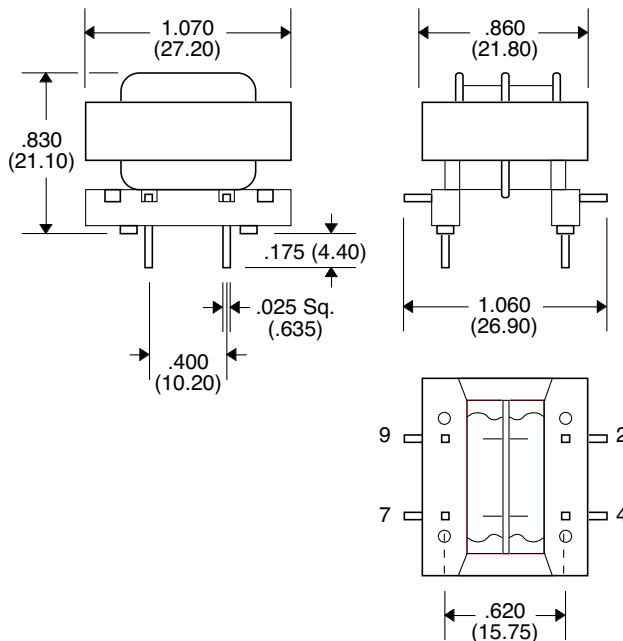

### Schematic



Unless Otherwise Specified Dimensions are in Inches /mm ± .010 / .25

# Power Choke

## EPZ3033-X

- Used in Power AC Line Filters, AC-AC Converters and Switching Power Supplies
- UL 94V-0 Recognized Components
- UL 1446 Class B Insulation System
- Meets or exceeds CSA/IEC/VDE/UL Specifications for Creepage, Clearance and Dielectric Strength
- 50 Hz - 500 Hz Switching Frequency
- 3750 Vrms Isolation
- In EE25 Standard Package

### Electrical Parameters @ 25° C

Part Number	Inductance (mH ± 25%) @ 1 KHz	DCR (Ω Max.)	Current Rating (Amperes Max.)	Temperature Rise (°C Max.) @ Max. Current
EPZ3033-332	3.3	.32	1.1	18
EPZ3033-392	3.9	.40	1.1	22
EPZ3033-472	4.7	.45	.88	16
EPZ3033-562	5.6	.50	.88	18
EPZ3033-682	6.8	.60	.88	21
EPZ3033-822	8.2	.70	.88	25
EPZ3033-103	10	.80	.70	18
EPZ3033-123	12	.90	.70	20
EPZ3033-153	15	1.0	.70	22
EPZ3033-183	18	1.3	.55	18
EPZ3033-223	22	1.5	.55	21
EPZ3033-273	27	1.8	.44	16
EPZ3033-333	33	2.2	.44	19
EPZ3033-393	39	2.6	.44	23
EPZ3033-473	47	2.8	.44	25
EPZ3033-563	56	4.0	.35	22
EPZ3033-683	68	5.0	.27	16
EPZ3033-104	82	5.5	.27	18
EPZ3033-124	100	6.4	.27	21
EPZ3033-222	120	7.8	.27	17
EPZ3033-154	150	9.0	.27	20

### Package

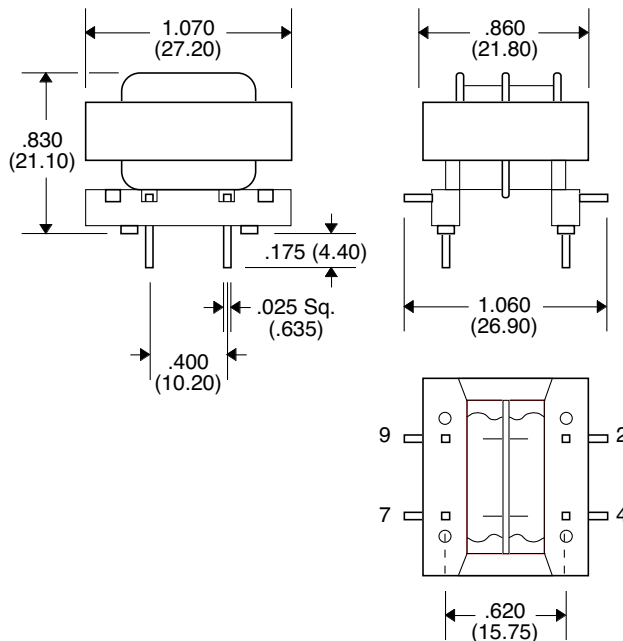

### Schematic



Unless Otherwise Specified Dimensions are in Inches /mm ± .010 / .25

## EPZ3037V-XXX

- Used as AC Power Line Filters in CTV, VTR, Audios, PC's, Facsimilies and Power Supply Applications
- UL940-V Recognized Materials
- Temperature Rise : 45°C Max.
- UL1446 Insulating System
- 2000 Vrms Isolation

### Electrical Parameters @ 25° C

Part Number	Inductance (mH Min.) [Pins 1-2, 4-3]	Current Rating (A rms Max.)
EPZ3037V-821	.82	2.0
EPZ3037V-122	1.2	1.6
EPZ3037V-182	1.8	1.5
EPZ3037V-222	2.2	1.3
EPZ3037V-272	2.7	1.1
EPZ3037V-332	3.3	1.1
EPZ3037V-392	3.9	1.0
EPZ3037V-562	5.6	0.8
EPZ3037V-682	6.8	0.7
EPZ3037V-822	8.2	0.6
EPZ3037V-103	10	0.6
EPZ3037V-183	18	0.5
EPZ3037V-223	22	0.4
EPZ3037V-333	33	0.3

### Impedance Characteristics

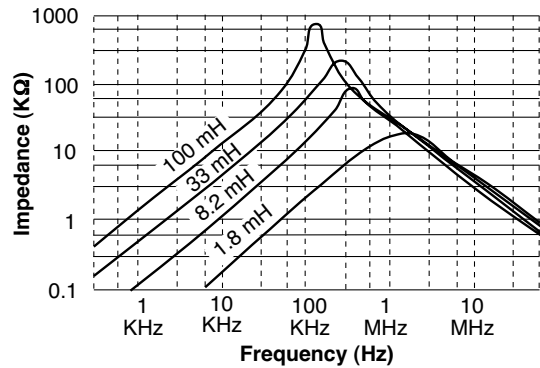

### Schematic

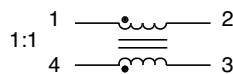

### Circuit Sample

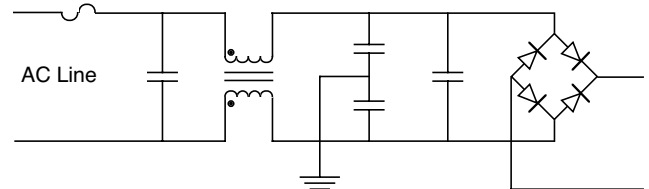

### Package

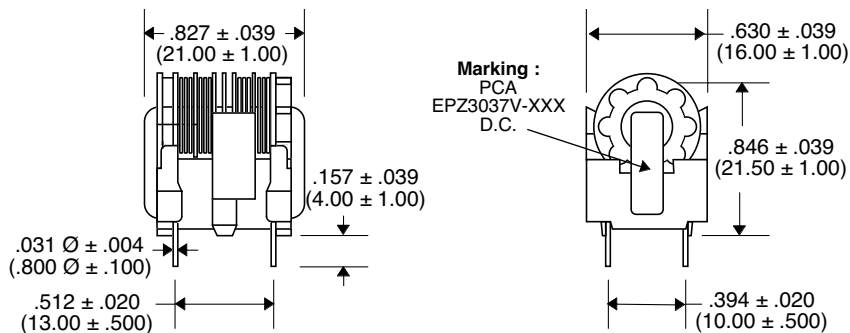

### Recommended PWB Piercing Plan

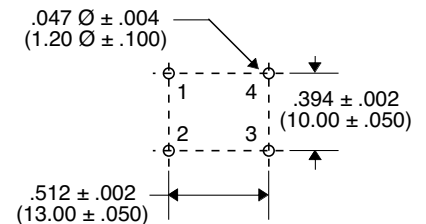

Unless Otherwise Specified Dimensions are in Inches /mm ± .010 / .25

## EPZ3040V-XXX

- Used as AC Power Line Filters in CTV, VTR, Audios, PC's, Facsimilies and Power Supply Applications
- UL940-V Recognized Materials
- Temperature Rise : 45°C Max.
- UL1446 Insulating System
- 2000 Vrms Isolation

### Electrical Parameters @ 25° C

Part Number	Inductance (mH Min.) [Pins 1-2, 4-3]	Current Rating (A rms Max.)
EPZ3040V-152	1.5	5.0
EPZ3040V-222	2.2	4.5
EPZ3040V-332	3.3	4.2
EPZ3040V-392	3.9	3.7
EPZ3040V-472	4.7	3.5
EPZ3040V-562	5.6	3.4
EPZ3040V-822	8.2	3.0
EPZ3040V-103	10	2.5
EPZ3040V-153	15	2.0
EPZ3040V-183	18	1.9
EPZ3040V-223	22	1.8
EPZ3040V-273	27	1.5
EPZ3040V-333	33	1.4
EPZ3040V-473	47	1.2
EPZ3040V-563	56	1.1
EPZ3040V-823	82	0.8

### Impedance Characteristics

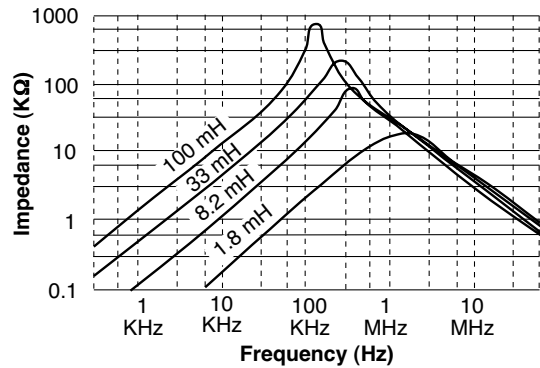

### Schematic

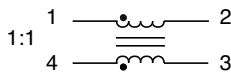

### Circuit Sample

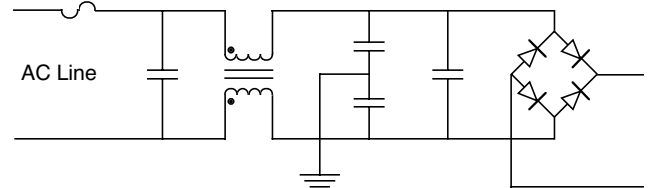

### Package

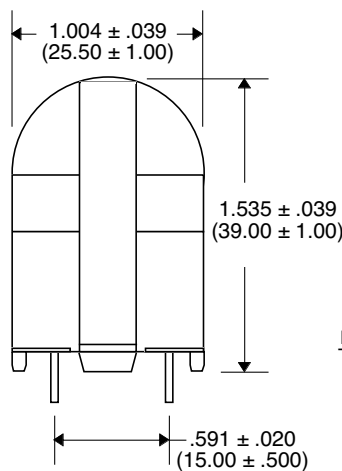
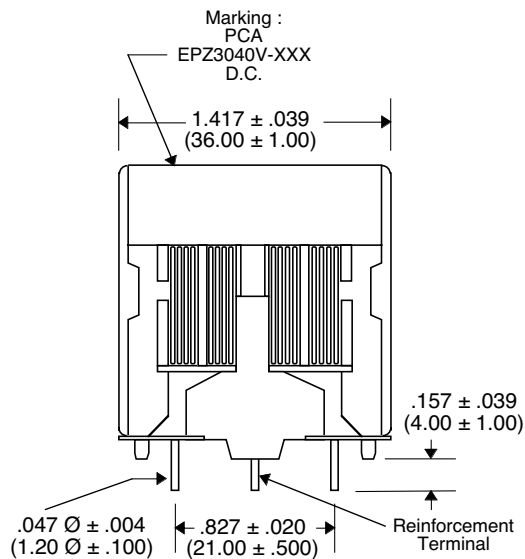

### Recommended PWB Piercing Plan

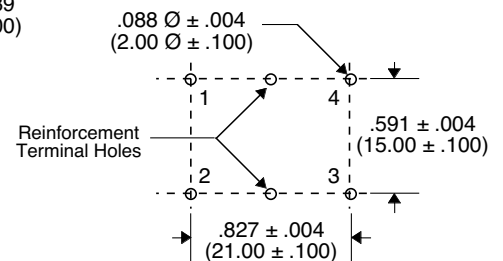

Unless Otherwise Specified Dimensions are in Inches /mm ± .010 / .25



## EPZ3041V-XXX

- Used as AC Power Line Filters in CTV, VTR, Audios, PC's, Facsimilies and Power Supply Applications
- UL940-V Recognized Materials
- Temperature Rise : 45°C Max.
- UL1446 Insulating System
- 2000 Vrms Isolation

**Electrical Parameters @ 25° C**

Part Number	Inductance (mH Min.) [Pins 1-2, 4-3]	Current Rating (A rms Max.)
EPZ3041V-222	2.2	3.0
EPZ3041V-272	2.7	2.7
EPZ3041V-452	4.5	2.5
EPZ3041V-562	5.6	2.2
EPZ3041V-682	6.8	2.0
EPZ3041V-822	8.2	1.8
EPZ3041V-123	12	1.6
EPZ3041V-153	15	1.3
EPZ3041V-183	18	1.2
EPZ3041V-273	27	1.0
EPZ3041V-333	33	0.8
EPZ3041V-563	56	0.7
EPZ3041V-683	68	0.6

**Impedance Characteristics**

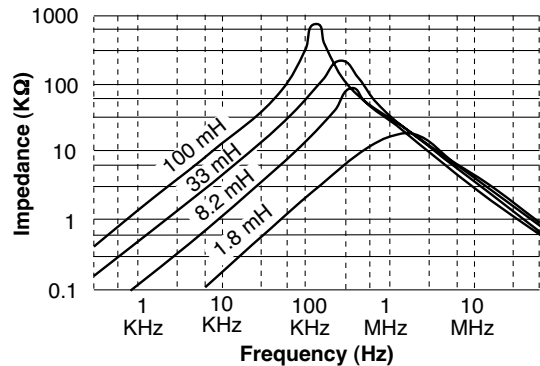

**Schematic**

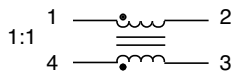

**Circuit Sample**

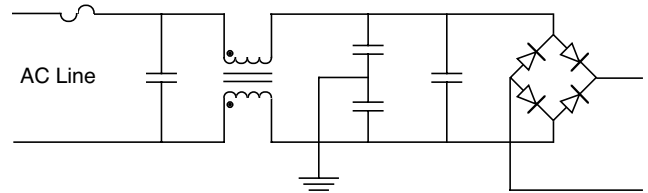

Marking :  
PCA  
EPZ3041V-XXX  
D.C.

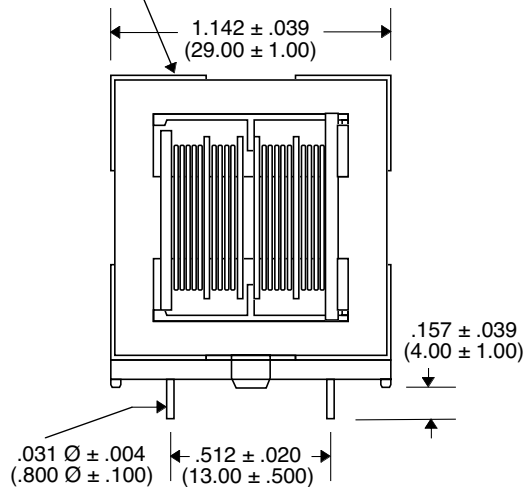

**Package**

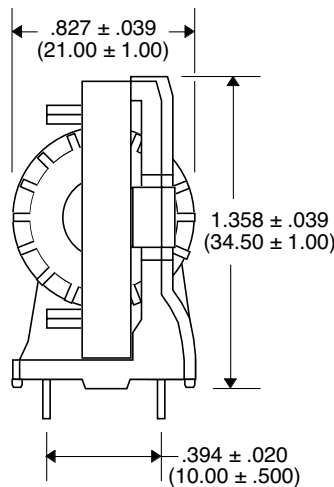

**Recommended PWB Piercing Plan**

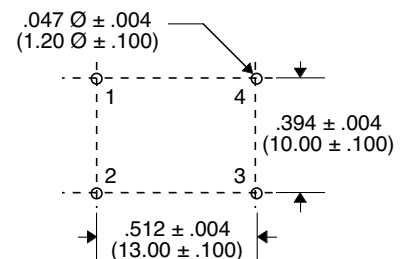

Unless Otherwise Specified Dimensions are in Inches /mm ±.010 /.25

# AC Power Line Choke

## EPZ3042V-XXX

- Used as AC Power Line Filters in CTV, VTR, Audios, PC's, Facsimilies and Power Supply Applications
- UL940-V Recognized Materials
- Temperature Rise : 45°C Max.
- UL1446 Insulating System
- 2000 Vrms Isolation

**Electrical Parameters @ 25° C**

Part Number	Inductance (mH Min.) [Pins 1-2, 4-3]	Current Rating (A rms Max.)
EPZ3042V-151	.15	10
EPZ3042V-261	.26	9.0
EPZ3042V-401	0.4	8.0
EPZ3042V-801	0.8	7.0
EPZ3042V-152	1.5	5.0
EPZ3042V-272	2.7	4.5
EPZ3042V-332	3.3	4.2
EPZ3042V-392	3.9	3.7
EPZ3042V-472	4.7	3.5
EPZ3042V-562	5.6	3.4
EPZ3042V-822	8.2	3.0
EPZ3042V-902	9.0	2.8
EPZ3042V-103	10	2.5
EPZ3042V-153	15	2.0
EPZ3042V-183	18	1.9
EPZ3042V-223	22	1.8
EPZ3042V-273	27	1.5
EPZ3042V-333	33	1.4
EPZ3042V-473	47	1.2
EPZ3042V-563	56	1.0
EPZ3042V-823	82	0.8

**Impedance Characteristics**

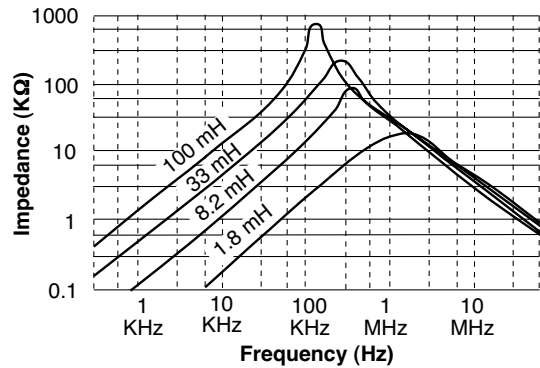

**Circuit Sample**

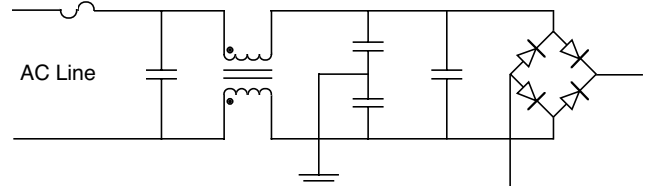

Marking :  
PCA  
EPZ3042V-XXX  
D.C.

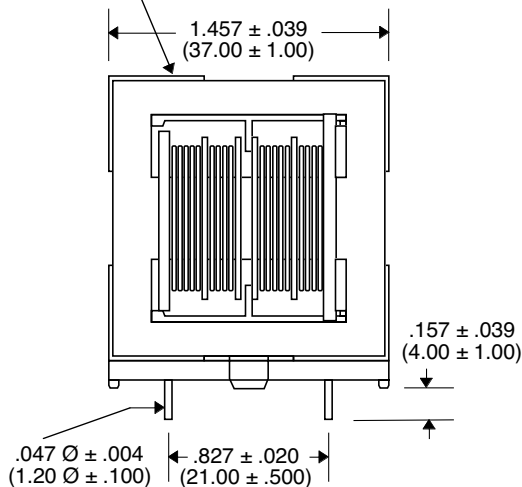

**Package**

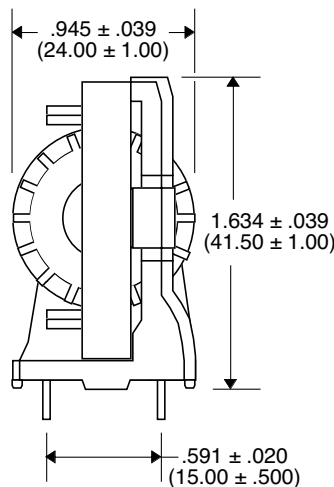

**Schematic**

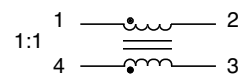

**Recommended PWB Piercing Plan**

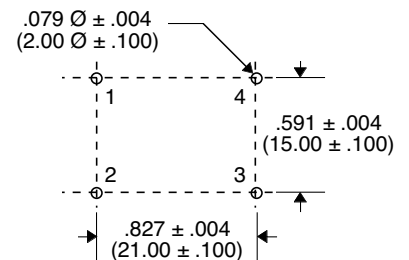

Unless Otherwise Specified Dimensions are in Inches /mm ±.010 /.25

## EPZ3043H-XXX

- Used as AC Power Line Filters in CTV, VTR, Audios, PC's, Facsimilies and Power Supply Applications
- UL940-V Recognized Materials
- Temperature Rise : 45°C Max.
- UL1446 Insulating System
- 2000 Vrms Isolation

### Electrical Parameters @ 25° C

Part Number	Inductance (mH Min.) [Pins 1-2, 4-3]	Current Rating (A rms Max.)
EPZ3043H-102	1.0	2.1
EPZ3043H-122	1.2	2.0
EPZ3043H-152	1.5	1.6
EPZ3043H-222	2.2	1.5
EPZ3043H-272	2.7	1.3
EPZ3043H-392	3.9	1.0
EPZ3043H-472	4.7	1.0
EPZ3043H-682	6.8	0.8
EPZ3043H-822	8.2	0.7
EPZ3043H-183	18	0.5
EPZ3043H-223	22	0.4
EPZ3043H-333	33	0.4
EPZ3043H-473	47	0.3
EPZ3043H-683	68	0.25

### Impedance Characteristics

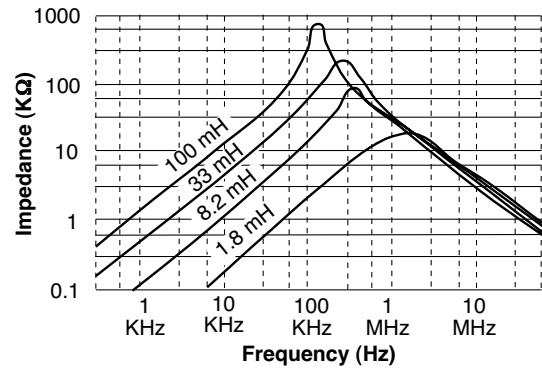

### Schematic

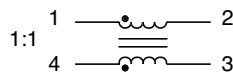

### Circuit Sample

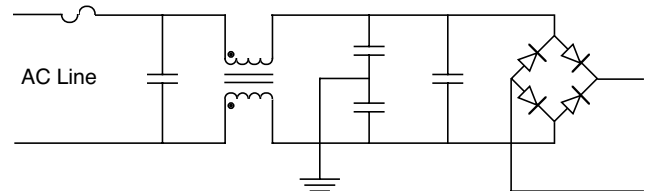

### Package

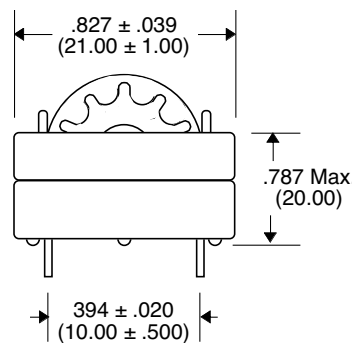
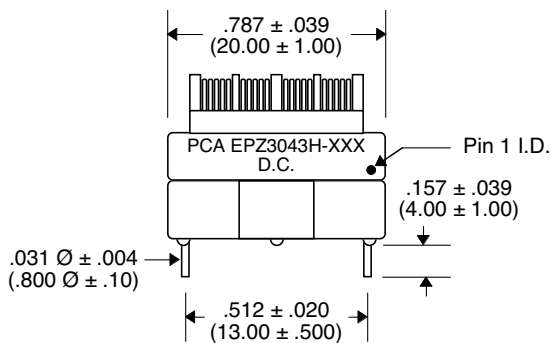

### Recommended PWB Piercing Plan

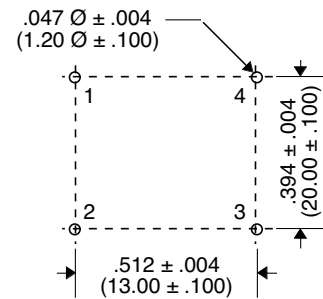

Unless Otherwise Specified Dimensions are in Inches /mm ±.010 /25

## EPZ3044H-XXX

- Used as AC Power Line Filters in CTV, VTR, Audios, PC's, Facsimilies and Power Supply Applications
- UL940-V Recognized Materials
- Temperature Rise : 45°C Max.
- UL1446 Insulating System
- 2000 Vrms Isolation

### Electrical Parameters @ 25° C

Part Number	Inductance (mH Min.) [Pins 1-2, 4-3]	Current Rating (A rms Max.)
EPZ3044H-182	1.8	1.5
EPZ3044H-272	2.7	1.1
EPZ3044H-562	5.6	0.8
EPZ3044H-682	6.8	0.7
EPZ3044H-103	10	0.6
EPZ3044H-183	18	0.5
EPZ3044H-223	22	0.4
EPZ3044H-333	33	0.3

### Impedance Characteristics

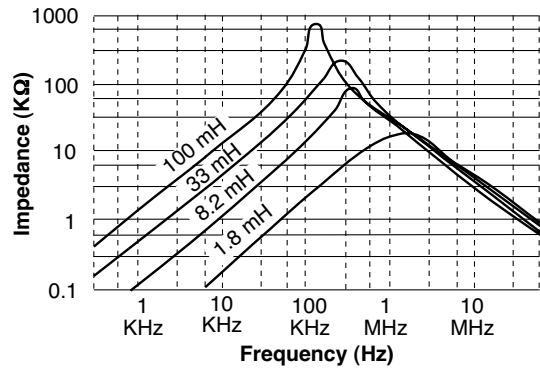

### Schematic

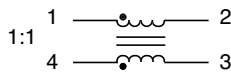

### Circuit Sample

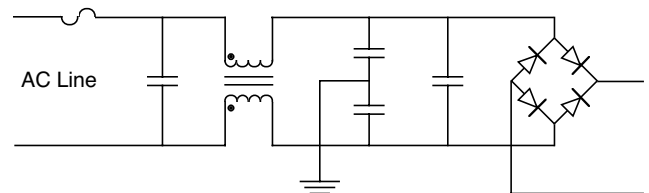

### Package

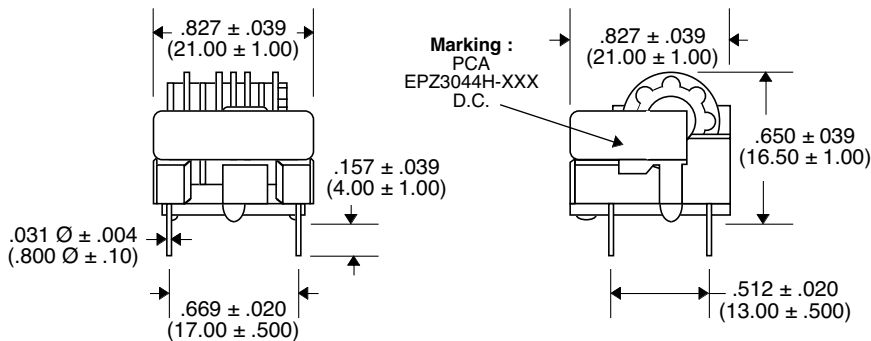

### Recommended PWB Piercing Plan

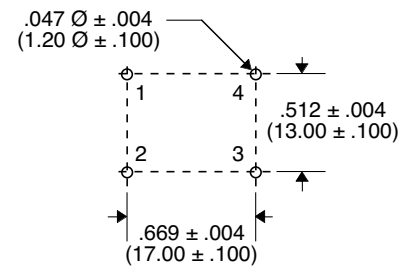

Unless Otherwise Specified Dimensions are in Inches /mm ±.010 /25

## EPZ3045H-XXX

- Used as AC Power Line Filters in CTV, VTR, Audios, PC's, Facsimilies and Power Supply Applications
- UL940-V Recognized Materials
- Temperature Rise : 45°C Max.
- UL1446 Insulating System
- 2000 Vrms Isolation

### Electrical Parameters @ 25° C

Part Number	Inductance (mH Min.) [Pins 1-2, 4-3]	Current Rating (A rms Max.)
EPZ3045H-561	.56	3.4
EPZ3045H-122	1.2	3.0
EPZ3045H-152	1.5	2.4
EPZ3045H-222	2.2	2.2
EPZ3045H-272	2.7	2.0
EPZ3045H-332	3.3	1.8
EPZ3045H-392	3.9	1.5
EPZ3045H-562	5.6	1.4
EPZ3045H-682	6.8	1.2
EPZ3045H-822	8.2	1.0
EPZ3045H-103	10	1.0
EPZ3045H-123	12	0.9
EPZ3045H-183	18	0.8
EPZ3045H-273	27	0.6
EPZ3045H-333	33	0.5
EPZ3045H-393	39	0.5
EPZ3045H-683	68	0.4

### Impedance Characteristics

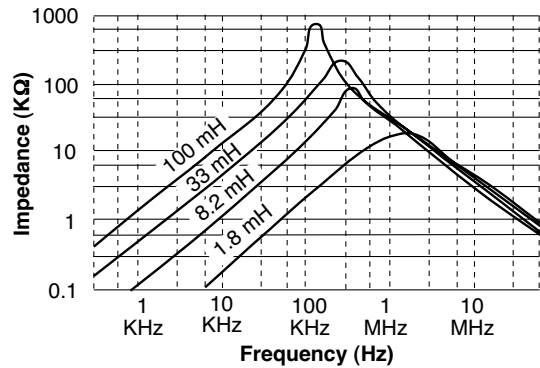

### Schematic

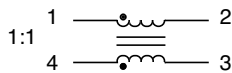

### Circuit Sample

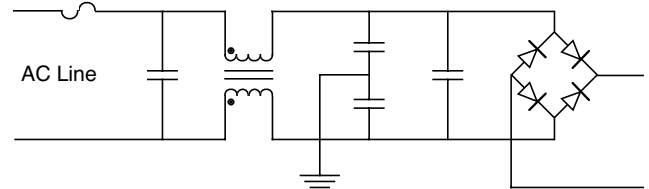

### Package

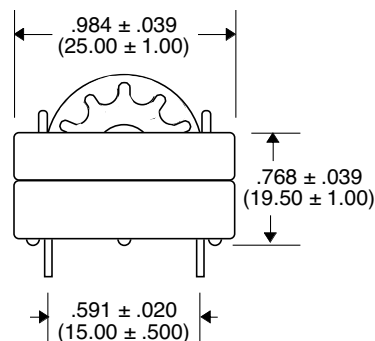
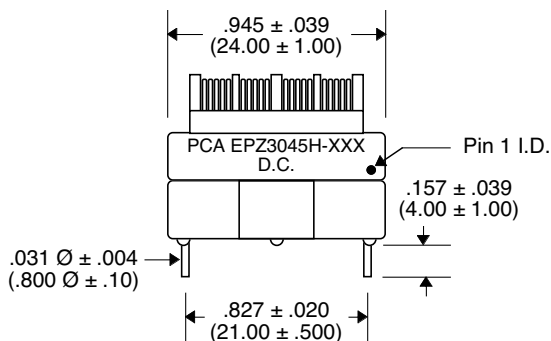

### Recommended PWB Piercing Plan

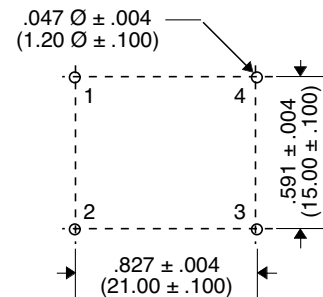

Unless Otherwise Specified Dimensions are in Inches /mm ±.010 /25

## EPZ3046H-XXX & EPZ3046H-XXX-LF



- Used as AC Power Line Filters in CTV, VTR, Audio, PC, Facsimile and Power Supply Applications
- Add "-LF" after part number for Lead-Free
- UL940-V Recognized Materials
- Temperature Rise : 45°C Max.
- UL1446 Insulating System
- 2000 Vrms Isolation

### Electrical Parameters @ 25° C

Part Number	Inductance (mH Min.) [Pins 1-2, 4-3]	Current Rating (A rms Max.)
EPZ3046H-102	1.0	3.4
EPZ3046H-152	1.5	3.1
EPZ3046H-182	1.8	2.8
EPZ3046H-222	2.2	2.8
EPZ3046H-272	2.7	2.6
EPZ3046H-332	3.3	2.5
EPZ3046H-392	3.9	2.2
EPZ3046H-472	4.7	2.0
EPZ3046H-472A	4.7	2.5
EPZ3046H-562	5.6	1.8
EPZ3046H-562A	5.6	2.1
EPZ3046H-822	8.2	1.7
EPZ3046H-103	10	1.6
EPZ3046H-123	12	1.6
EPZ3046H-183	18	1.2
EPZ3046H-223	22	1.0
EPZ3046H-273	27	0.8
EPZ3046H-333	33	0.8
EPZ3046H-393	39	0.7
EPZ3046H-683	68	0.5

### Impedance Characteristics

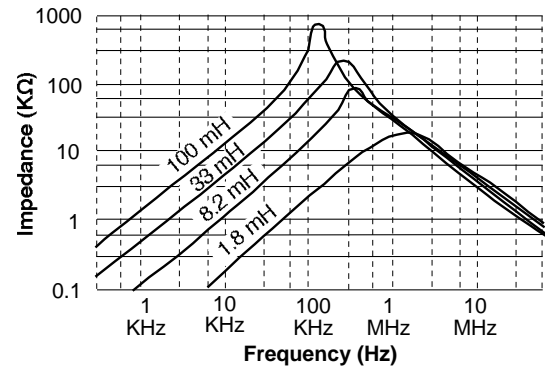

### Circuit Sample

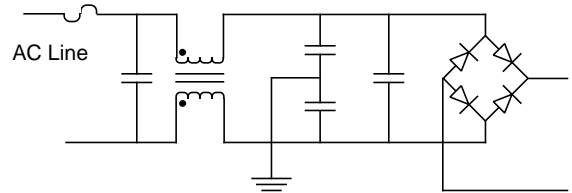

### Schematic

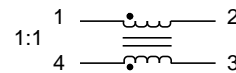

Notes :	EPZ3046H-XXX	EPZ3046H-XXX-LF
1. Assembly Process (Assembly Solder) (Solder Composition)	SnPb	SnAg
2. Peak Solder Rating (per JESD22-B106-B)	260°C 10 (+2/-0) seconds	260°C 10 (+2/-0) seconds
3. Weight	TBD grams	TBD grams
4. Packaging Information (Tray)	TBD pieces/tray	TBD pieces/tray

### Package

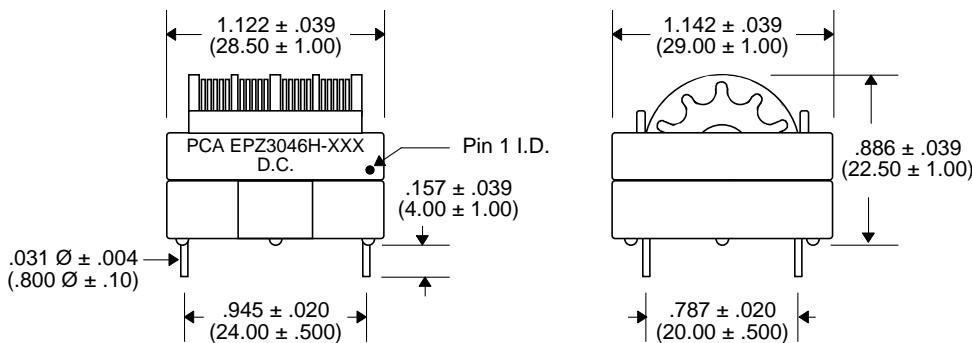

### Recommended PWB Piercing Plan

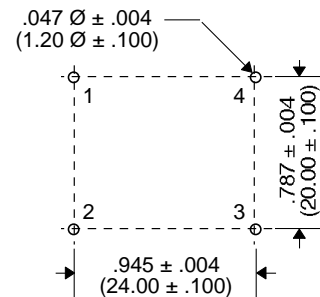

Unless Otherwise Specified Dimensions are in Inches /mm ± .010 / .25

## EPZ3047F-XXX

- Used as AC Power Line Filters in CTV, VTR, Audios, PC's, Facsimilies and Power Supply Applications
- UL940-V Recognized Materials
- Temperature Rise : 45°C Max.
- UL1446 Insulating System
- 2000 Vrms Isolation

### Electrical Parameters @ 25° C

Part Number	Inductance (mH Min.) [Pins 1-2, 4-3]	Current Rating (A rms Max.)
EPZ3047F-102	1.0	2.2
EPZ3047F-122	1.2	2.0
EPZ3047F-152	1.5	1.8
EPZ3047F-202	2.0	1.6
EPZ3047F-252	2.5	1.4
EPZ3047F-352	3.5	1.2
EPZ3047F-502	5.0	1.0
EPZ3047F-602	6.0	0.9
EPZ3047F-802	8.0	0.8
EPZ3047F-103	10	0.7
EPZ3047F-143	14	0.6
EPZ3047F-203	20	0.5
EPZ3047F-303	30	0.4
EPZ3047F-503	50	0.3

### Impedance Characteristics

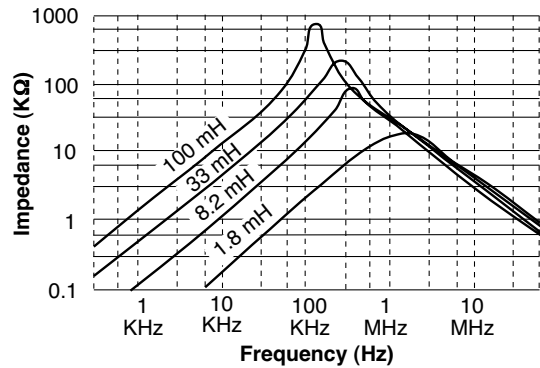

### Schematic

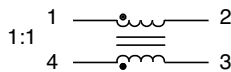

### Circuit Sample

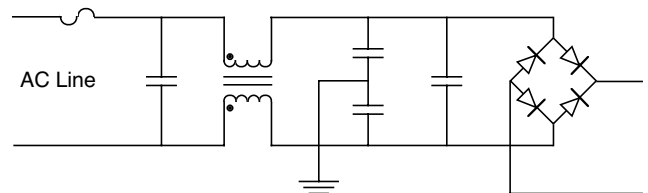

### Package

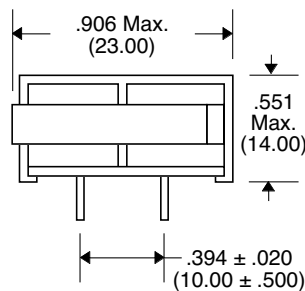
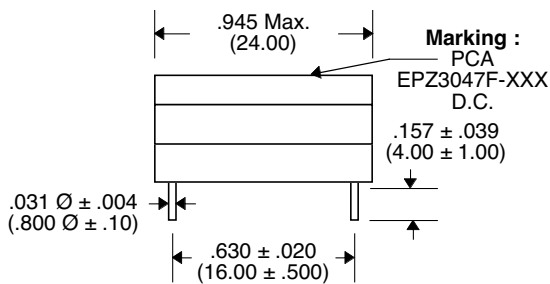

### Recommended PWB Piercing Plan

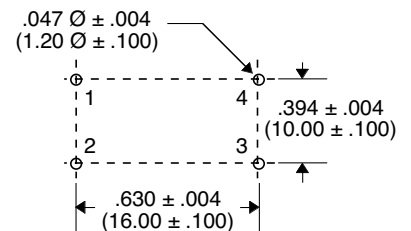

Unless Otherwise Specified Dimensions are in Inches /mm ± .010 / .25

## EPZ3048F-XXX

- Used as AC Power Line Filters in CTV, VTR, Audios, PC's, Facsimilies and Power Supply Applications
- UL940-V Recognized Materials
- Temperature Rise : 45°C Max.
- UL1446 Insulating System
- 2000 Vrms Isolation

### Electrical Parameters @ 25° C

Part Number	Inductance (mH Min.) [Pins 1-2, 4-3]	Current Rating (A rms Max.)
EPZ3048F-132	1.3	2.5
EPZ3048F-162	1.6	2.2
EPZ3048F-202	2.0	2.0
EPZ3048F-252	2.5	1.8
EPZ3048F-302	3.0	1.6
EPZ3048F-302A	3.0	1.8
EPZ3048F-402	4.0	1.4
EPZ3048F-402A	4.0	1.6
EPZ3048F-502	5.0	1.4
EPZ3048F-552	5.5	1.2
EPZ3048F-702	7.0	1.2
EPZ3048F-802	8.0	1.0
EPZ3048F-103	10	0.9
EPZ3048F-103A	10	1.0
EPZ3048F-123	12	0.8
EPZ3048F-123A	12	0.9
EPZ3048F-153	15	0.8
EPZ3048F-163	16	0.7
EPZ3048F-203	20	0.6
EPZ3048F-203A	20	0.7
EPZ3048F-283	28	0.6
EPZ3048F-303	30	0.5
EPZ3048F-503	50	0.4

### Impedance Characteristics

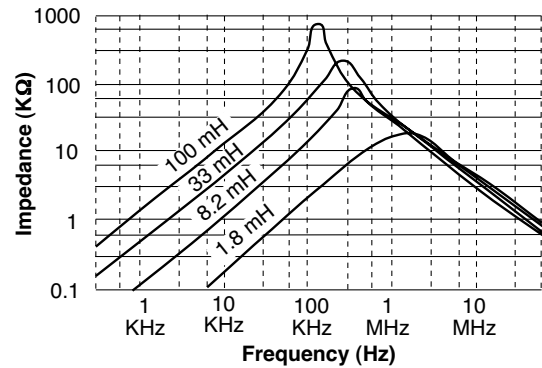

### Schematic



### Circuit Sample

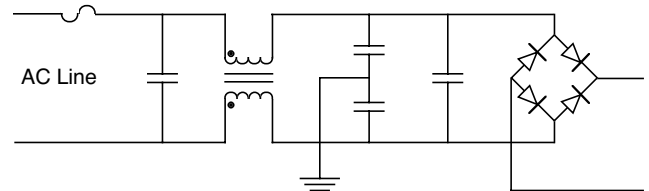

### Package

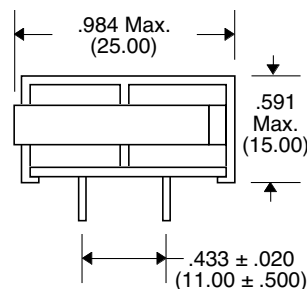
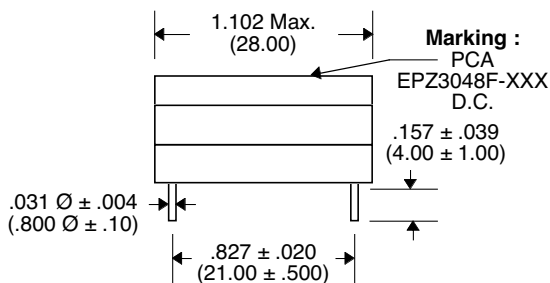

### Recommended PWB Piercing Plan

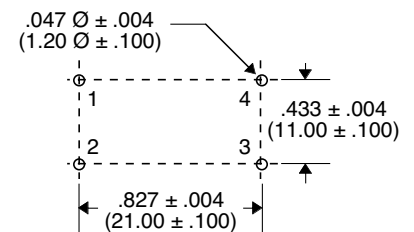

Unless Otherwise Specified Dimensions are in Inches /mm ± .010 / .25



- Used as AC Power Line Filters in CTV, VTR, Audios, PC's, Facsimilies and Power Supply Applications
- UL940-V Recognized Materials
- Temperature Rise : 45°C Max.
- UL1446 Insulating System
- 2000 Vrms Isolation

### Electrical Parameters @ 25° C

Part Number	Inductance (mH Min.) [Pins 1-2, 4-3]	Current Rating (A rms Max.)
EPZ3049M-501	0.5	1.0
EPZ3049M-701	0.7	0.9
EPZ3049M-801	0.8	0.8
EPZ3049M-102	1.0	0.7
EPZ3049M-152	1.5	0.6
EPZ3049M-252	2.5	0.5
EPZ3049M-352	3.5	0.4
EPZ3049M-602	6.0	0.3
EPZ3049M-123	12	0.2
EPZ3049M-303	30	0.1

### Impedance Characteristics

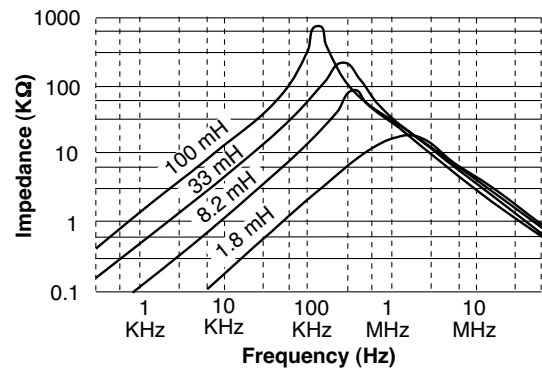

### Schematic

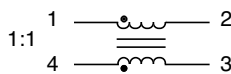

### Circuit Sample

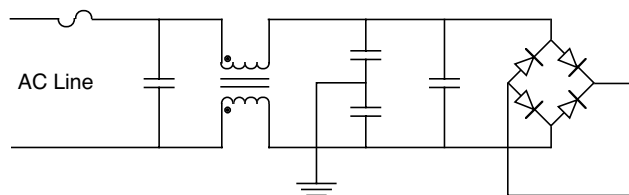

### Package

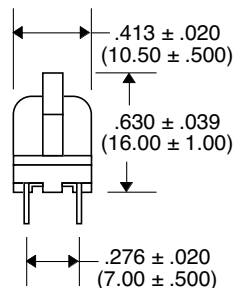
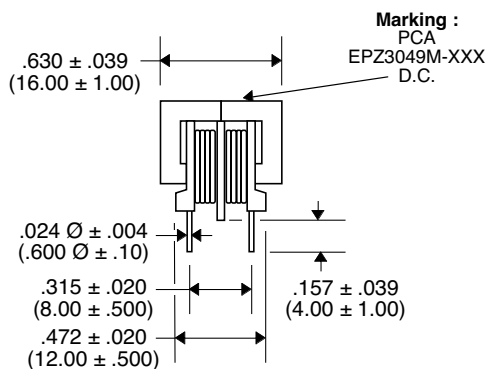

### Recommended PWB Piercing Plan

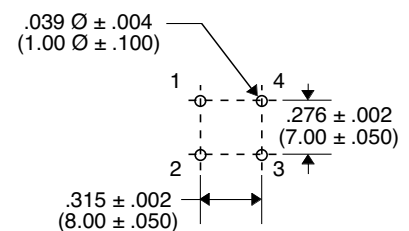

Unless Otherwise Specified Dimensions are in Inches /mm ± .010 / .25

# AC Power Line Choke

## EPZ3050M-XXX

- Used as AC Power Line Filters in CTV, VTR, Audios, PC's, Facsimilies and Power Supply Applications
- UL940-V Recognized Materials
- Temperature Rise : 45°C Max.
- UL1446 Insulating System
- 2000 Vrms Isolation

### Electrical Parameters @ 25° C

Part Number	Inductance (mH Min.) [Pins 1-2, 4-3]	Current Rating (A rms Max.)
EPZ3050M-501	0.5	1.0
EPZ3050M-701	0.7	0.9
EPZ3050M-801	0.8	0.8
EPZ3050M-102	1.0	0.7
EPZ3050M-152	1.5	0.6
EPZ3050M-252	2.5	0.5
EPZ3050M-352	3.5	0.4
EPZ3050M-602	6.0	0.3
EPZ3050M-123	12	0.2
EPZ3050M-303	30	0.1

### Impedance Characteristics

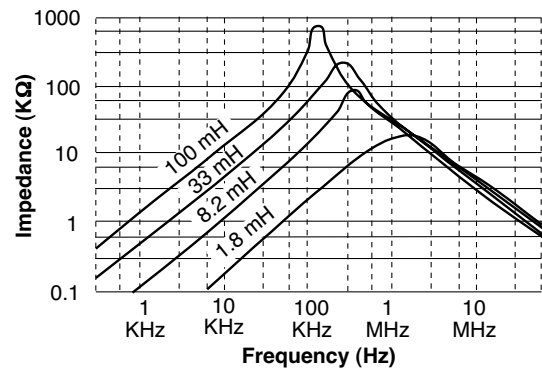

### Schematic

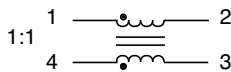

### Circuit Sample

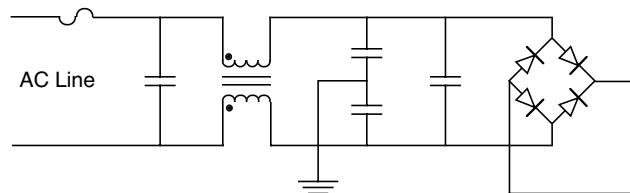

### Package

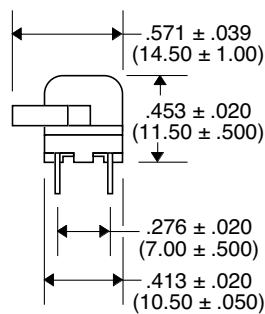
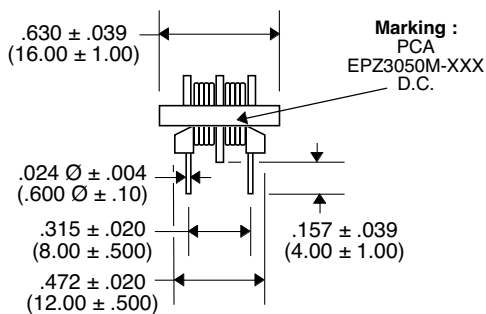

### Recommended PWB Piercing Plan

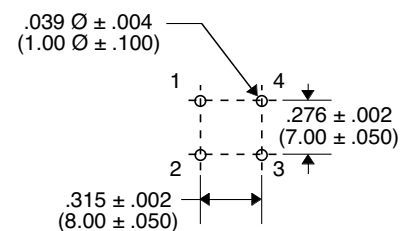

Unless Otherwise Specified Dimensions are in Inches /mm ± .010 / .25

## EPZ3051M-XXX

- Used as AC Power Line Filters in CTV, VTR, Audios, PC's, Facsimilies and Power Supply Applications
- UL940-V Recognized Materials
- Temperature Rise : 45°C Max.
- UL1446 Insulating System
- 2000 Vrms Isolation

### Electrical Parameters @ 25° C

Part Number	Inductance (mH Min.) [Pins 1-2, 4-3]	Current Rating (A rms Max.)
EPZ3051M-501	0.5	2.0
EPZ3051M-601	0.6	1.7
EPZ3051M-801	0.8	1.5
EPZ3051M-102	1.0	1.3
EPZ3051M-202	2.0	1.0
EPZ3051M-352	3.5	0.8
EPZ3051M-502	5.0	0.7
EPZ3051M-702	7.0	0.6
EPZ3051M-802	8.0	0.5
EPZ3051M-153	15	0.4
EPZ3051M-203	20	0.3
EPZ3051M-283	28	0.2

### Impedance Characteristics

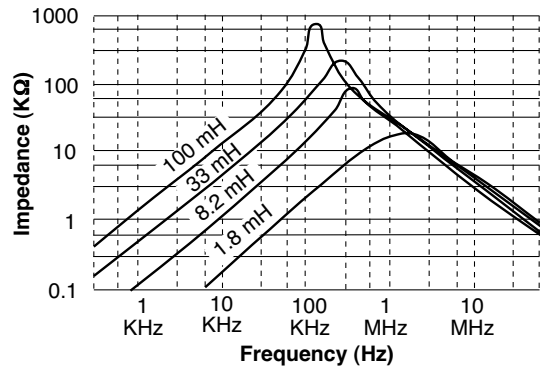

### Schematic

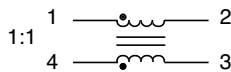

### Circuit Sample

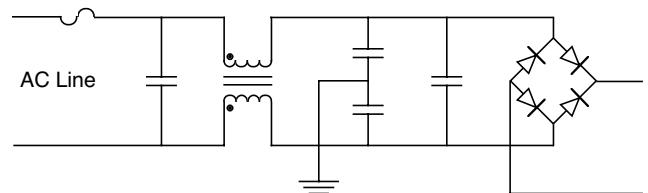

### Package

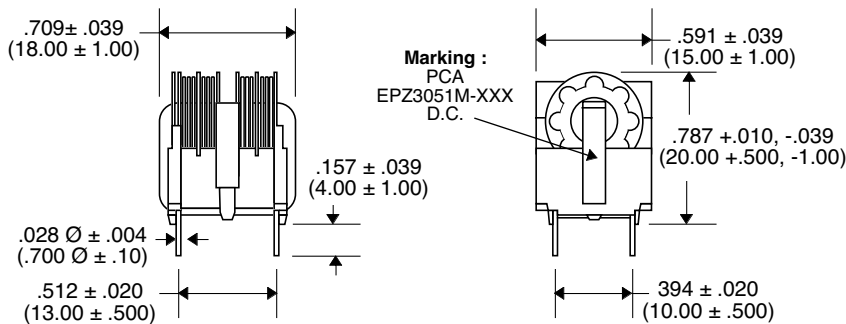

### Recommended PWB Piercing Plan

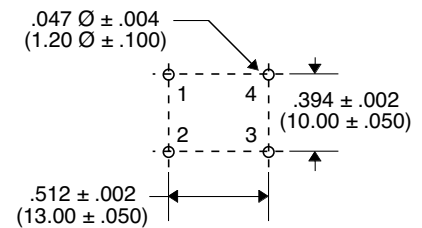

Unless Otherwise Specified Dimensions are in Inches /mm ±.010 /.25

## EPZ3052N-XXX

- Used as AC Power Line Filters in CTV, VTR, Audios, PC's, Facsimilies and Power Supply Applications
- UL940-V Recognized Materials
- Temperature Rise : 45°C Max.
- UL1446 Insulating System
- 2000 Vrms Isolation

### Electrical Parameters @ 25° C

Part Number	Inductance (mH Min.) [Pins 1-2, 4-3]	Current Rating (A rms Max.)
EPZ3052N-601	0.6	3.0
EPZ3052N-102	1.0	2.2
EPZ3052N-172	1.7	1.7
EPZ3052N-212	2.1	1.5
EPZ3052N-272	2.7	1.3
EPZ3052N-402	4.0	1.1
EPZ3052N-532	5.3	1.0
EPZ3052N-682	6.8	0.8
EPZ3052N-103	10	0.7
EPZ3052N-123	12	0.6
EPZ3052N-193	19	0.5
EPZ3052N-263	26	0.4
EPZ3052N-433	43	0.3
EPZ3052N-104	104	0.2

### Impedance Characteristics

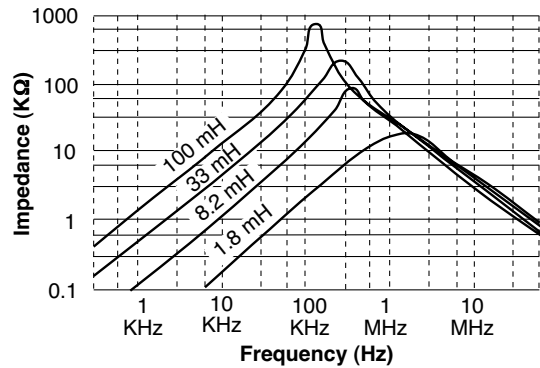

### Package

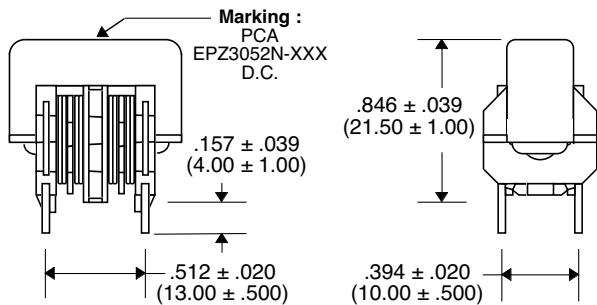

### Circuit Sample

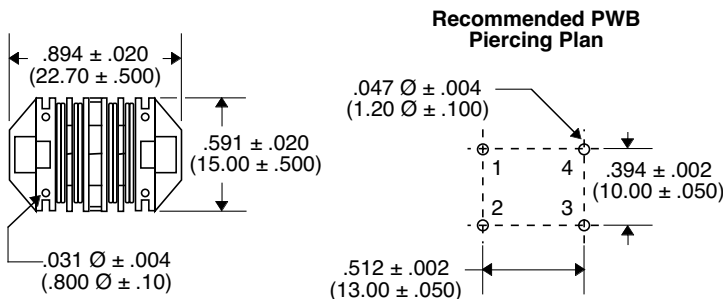
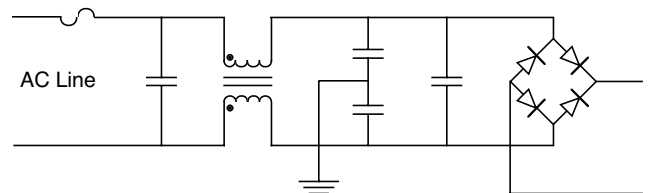

### Schematic

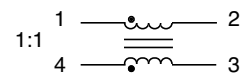

Unless Otherwise Specified Dimensions are in Inches /mm ±.010 / .25

## EPZ3053N-XXX

- Used as AC Power Line Filters in CTV, VTR, Audios, PC's, Facsimilies and Power Supply Applications
- UL940-V Recognized Materials
- Temperature Rise : 45°C Max.
- UL1446 Insulating System
- 2000 Vrms Isolation

### Electrical Parameters @ 25° C

Part Number	Inductance (mH Min.) [Pins 1-2, 4-3]	Current Rating (A rms Max.)
EPZ3053N-142	1.4	3.2
EPZ3053N-242	2.4	2.5
EPZ3053N-422	4.2	2.0
EPZ3053N-602	6.0	1.6
EPZ3053N-952	9.5	1.2
EPZ3053N-153	15	1.0
EPZ3053N-203	20	0.8
EPZ3053N-353	35	0.6
EPZ3053N-503	50	0.5
EPZ3053N-803	80	0.4

### Impedance Characteristics

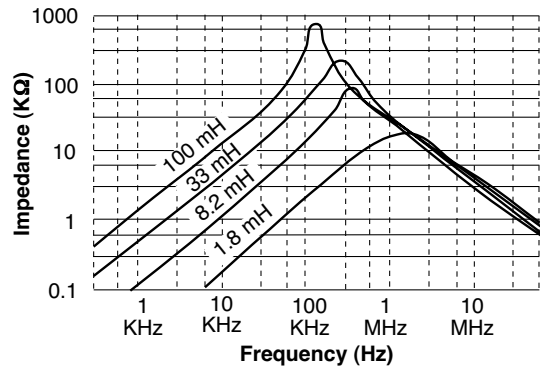

### Package

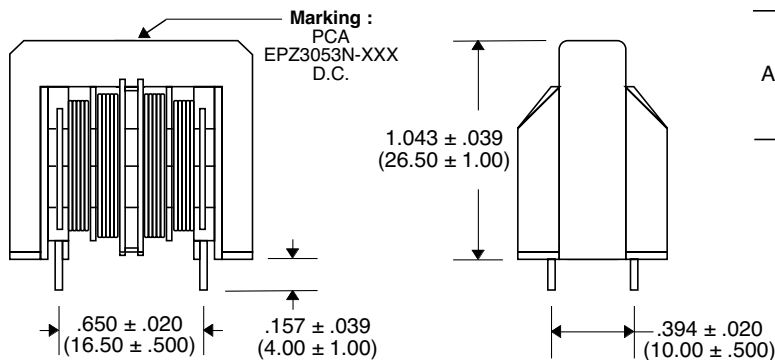

### Circuit Sample

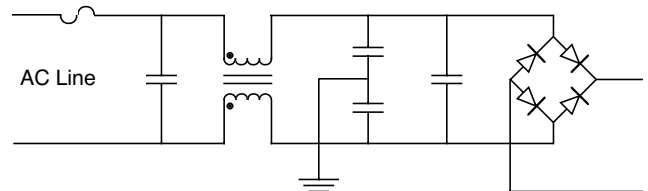

### Schematic

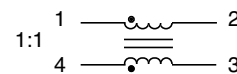

### Recommended PWB Piercing Plan

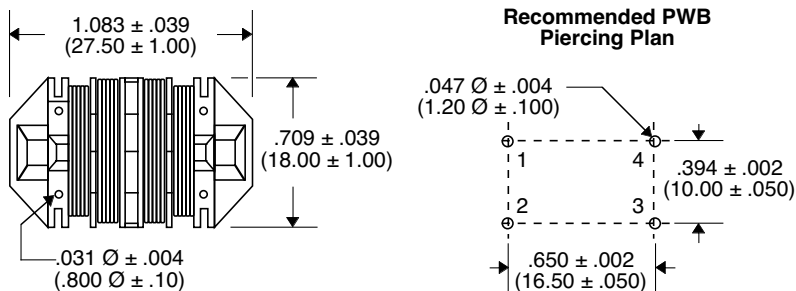

Unless Otherwise Specified Dimensions are in Inches /mm ±.010 / .25

## EPZ3054N-XXX

- Used as AC Power Line Filters in CTV, VTR, Audios, PC's, Facsimilies and Power Supply Applications
- UL940-V Recognized Materials
- Temperature Rise : 45°C Max.
- UL1446 Insulating System
- 2000 Vrms Isolation

### Electrical Parameters @ 25° C

Part Number	Inductance (mH Min.) [Pins 1-2, 4-3]	Current Rating (A rms Max.)
EPZ3054N-152	1.5	4.0
EPZ3054N-202	2.0	3.5
EPZ3054N-292	2.9	3.0
EPZ3054N-472	4.7	2.7
EPZ3054N-492	4.9	2.4
EPZ3054N-622	6.2	2.2
EPZ3054N-702	7.0	2.0
EPZ3054N-752	7.5	1.8
EPZ3054N-123	12	1.6
EPZ3054N-143	14	1.5
EPZ3054N-183	18	1.3
EPZ3054N-283	28	1.0
EPZ3054N-433	43	0.8
EPZ3054N-693	69	0.6

### Impedance Characteristics

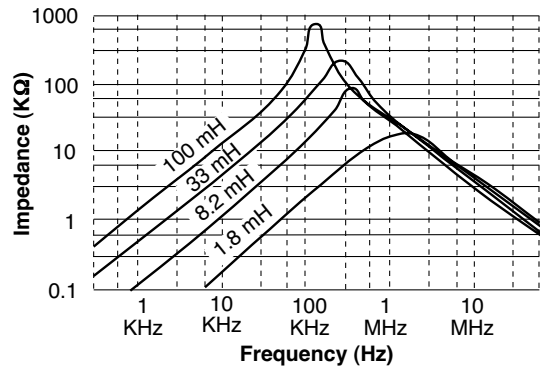

### Package

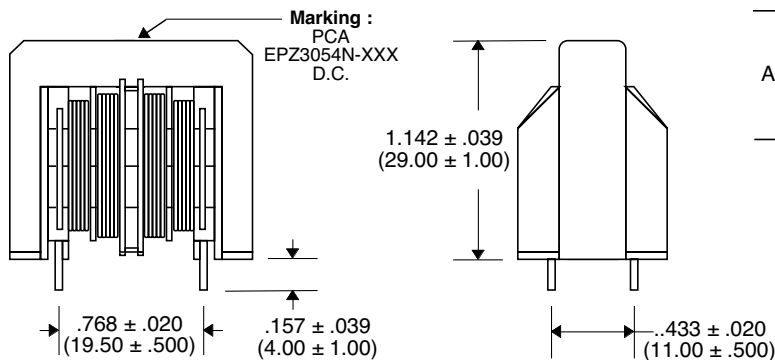

### Circuit Sample

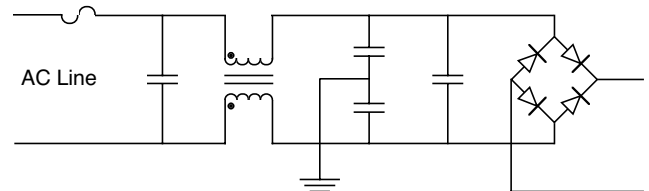

### Schematic

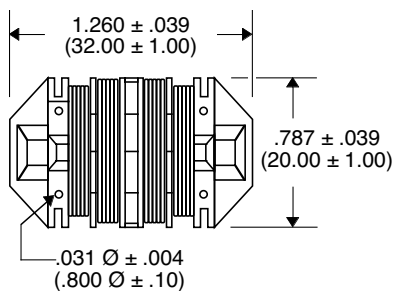
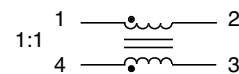

### Recommended PWB Piercing Plan

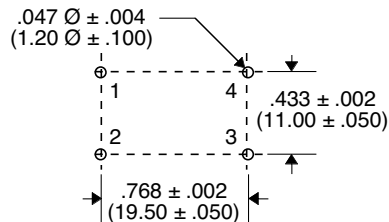

Unless Otherwise Specified Dimensions are in Inches /mm ± .010 / .25

- Used as AC Power Line Filters in CTV, VTR, Audios, PC's, Facsimilies and Power Supply Applications
- UL940-V Recognized Materials
- Temperature Rise : 45°C Max.
- UL1446 Insulating System
- 2000 Vrms Isolation

### Electrical Parameters @ 25° C

Part Number	Inductance (mH Min.) [Pins 1-2, 4-3]	Current Rating (A rms Max.)
EPZ3055HN-801	0.8	3.0
EPZ3055HN-132	1.3	2.2
EPZ3055HN-232	2.3	1.7
EPZ3055HN-292	2.9	1.5
EPZ3055HN-372	3.7	1.3
EPZ3055HN-542	5.4	1.1
EPZ3055HN-722	7.2	1.0
EPZ3055HN-922	9.2	0.8
EPZ3055HN-143	14	0.7
EPZ3055HN-163	16	0.6
EPZ3055HN-263	26	0.5
EPZ3055HN-353	35	0.4
EPZ3055HN-603	60	0.3
EPZ3055HN-143	142	0.2

### Impedance Characteristics

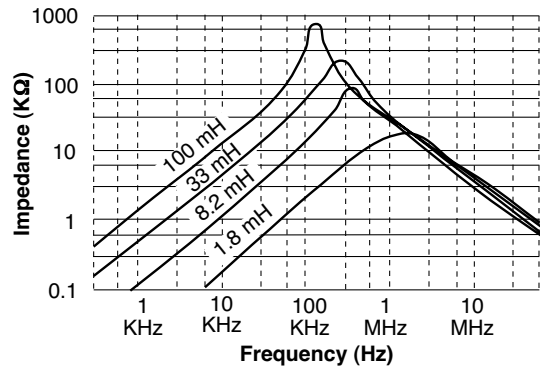

### Package

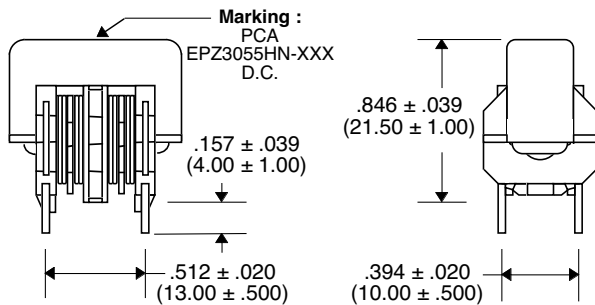

### Circuit Sample

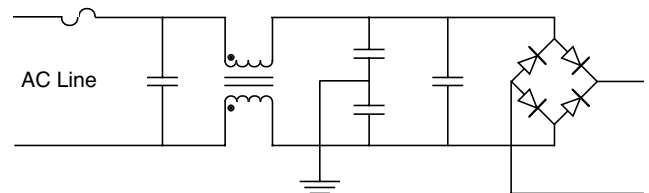

### Recommended PWB Piercing Plan

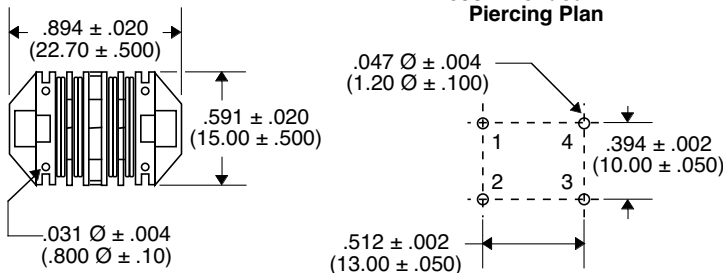

### Schematic

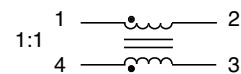

Unless Otherwise Specified Dimensions are in Inches /mm ±.010 /25

- Used as AC Power Line Filters in CTV, VTR, Audios, PC's, Facsimilies and Power Supply Applications
- UL940-V Recognized Materials
- Temperature Rise : 45°C Max.
- UL1446 Insulating System
- High Inductance Series
- 2000 Vrms Isolation

### Electrical Parameters @ 25° C

Part Number	Inductance (mH Min.) [Pins 1-2, 4-3]	Current Rating (A rms Max.)
EPZ3056HN-172	1.7	3.2
EPZ3056HN-302	3.0	2.5
EPZ3056HN-512	5.1	2.0
EPZ3056HN-742	7.4	1.6
EPZ3056HN-123	12	1.2
EPZ3056HN-193	19	1.0
EPZ3056HN-253	25	0.8
EPZ3056HN-443	43	0.6
EPZ3056HN-623	62	0.5
EPZ3056HN-993	99	0.4

### Impedance Characteristics

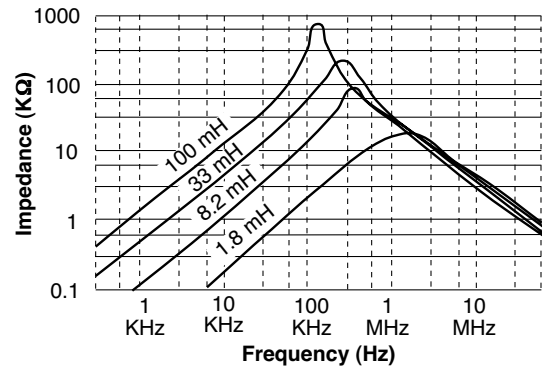

### Package

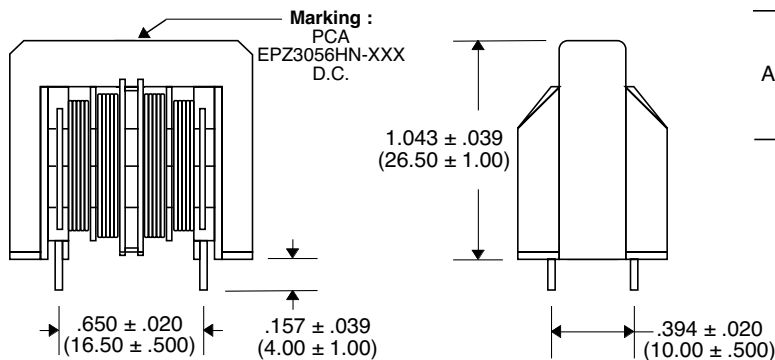

### Circuit Sample

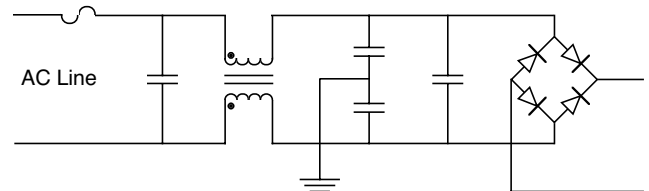

### Schematic

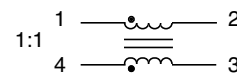

### Recommended PWB Piercing Plan

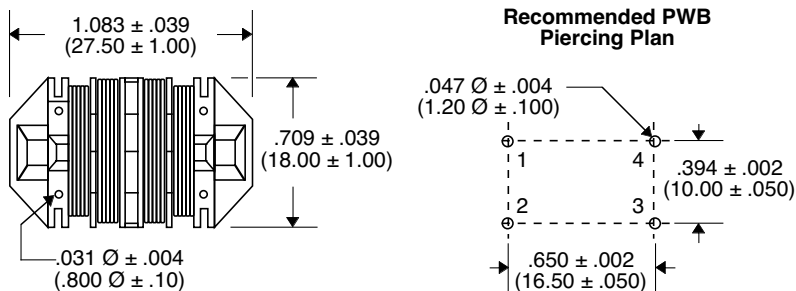

Unless Otherwise Specified Dimensions are in Inches /mm ±.010 /25



- Used as AC Power Line Filters in CTV, VTR, Audios, PC's, Facsimilies and Power Supply Applications
- UL940-V Recognized Materials
- Temperature Rise : 45°C Max.
- UL1446 Insulating System
- High Inductance Series
- 2000 Vrms Isolation

### Electrical Parameters @ 25° C

Part Number	Inductance (mH Min.) [Pins 1-2, 4-3]	Current Rating (A rms Max.)
EPZ3057HN-192	1.9	4.0
EPZ3057HN-252	2.5	3.5
EPZ3057HN-372	3.7	3.0
EPZ3057HN-582	5.8	2.7
EPZ3057HN-612	6.1	2.4
EPZ3057HN-782	7.8	2.2
EPZ3057HN-872	8.7	2.0
EPZ3057HN-942	9.4	1.8
EPZ3057HN-153	15	1.6
EPZ3057HN-183	18	1.5
EPZ3057HN-223	22	1.3
EPZ3057HN-363	36	1.0
EPZ3057HN-543	54	0.8
EPZ3057HN-873	87	0.6

### Impedance Characteristics

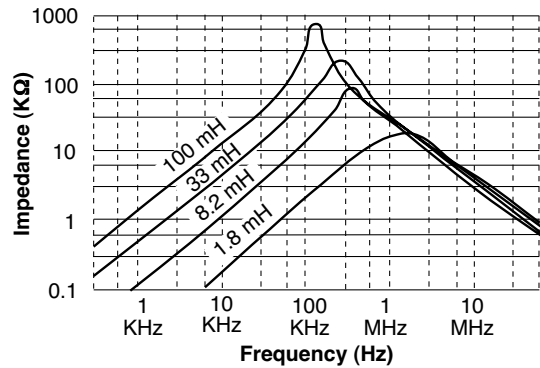

### Package

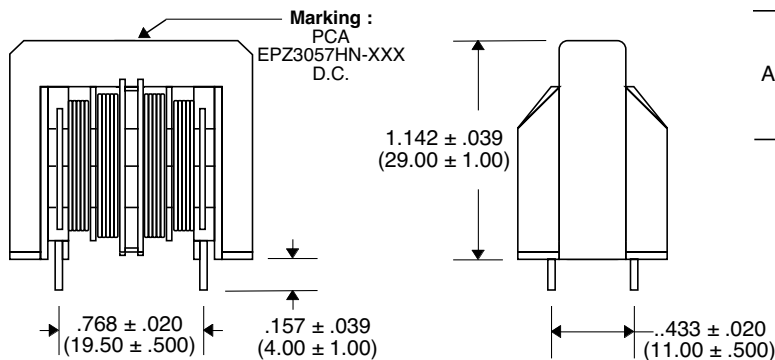

### Circuit Sample

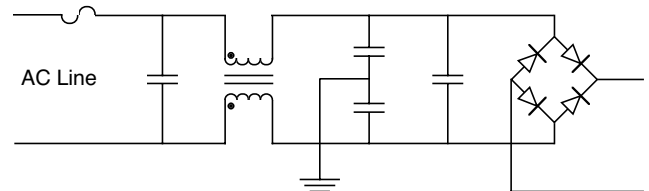

### Schematic

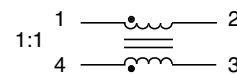

### Recommended PWB Piercing Plan

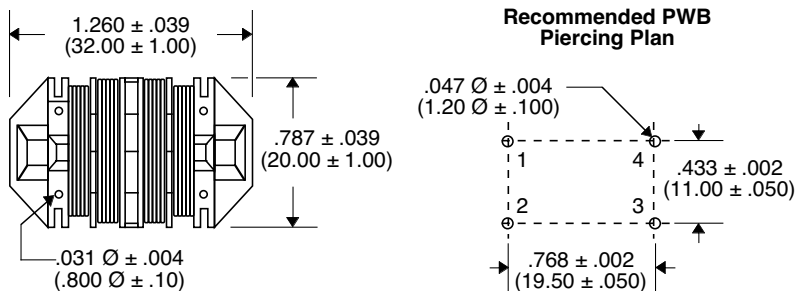

Unless Otherwise Specified Dimensions are in Inches /mm ±.010 / .25

# AC Power Line Choke EPZ3058-XXX

- Used as AC Power Line Filters in CTV, VTR, Audios, PC's, Facsimilies and Power Supply Applications
- Applicable Frequency : 0.1 MHz to 10 MHz
- Low Profile In Vertical Core Layout
- UL940-V Recognized Materials
- Temperature Rise : 45°C Max.
- UL1446 Insulating System
- 2000 Vrms Isolation
- 2-Section Bobbin

### Electrical Parameters @ 25° C

Part Number	Inductance (mH Min.) [Pins 1-2, 4-3]	Current Rating (A rms Max.)
EPZ3058-901	0.9	2.0
EPZ3058-182	1.8	1.6
EPZ3058-452	4.5	1.0
EPZ3058-722	7.2	0.8
EPZ3058-902	9.0	0.7
EPZ3058-183	18	0.5
EPZ3058-273	27	0.4

### Impedance Characteristics

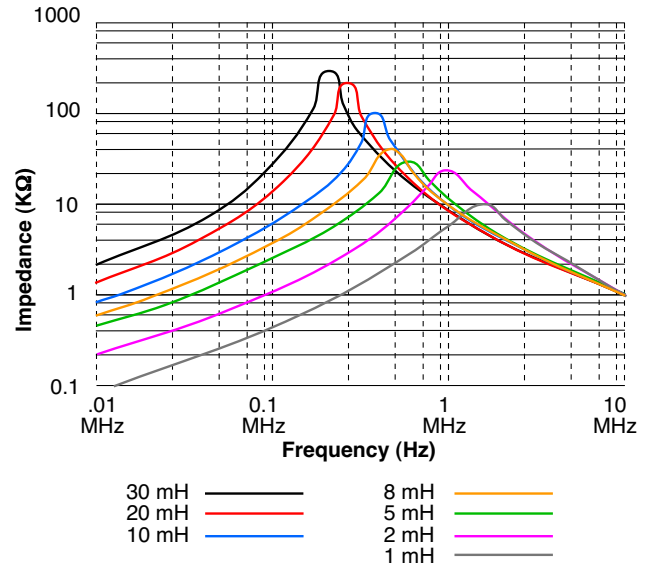

### Circuit Sample

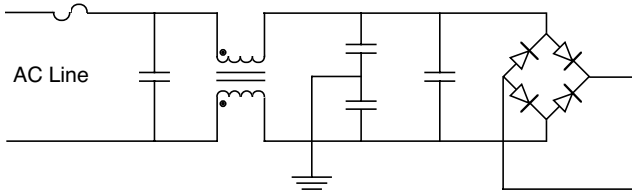

### Schematic

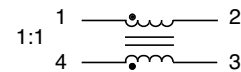

### Recommended PWB Piercing Plan

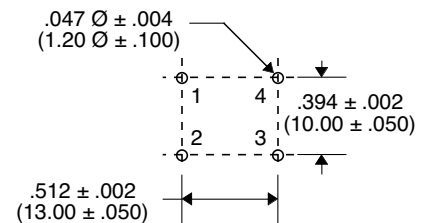

### Package

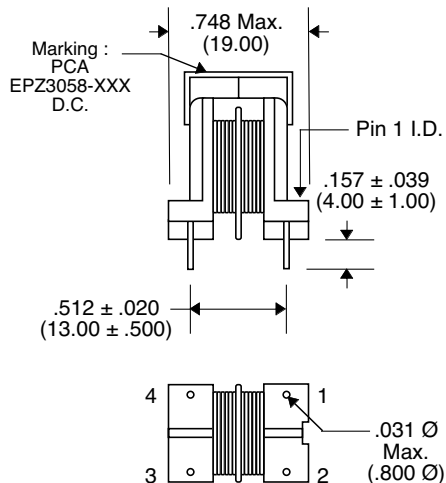

Unless Otherwise Specified Dimensions are in Inches /mm ± .010 / .25

# AC Power Line Choke EPZ3059-XXX

- Used as AC Power Line Filters in CTV, VTR, Audios, PC's, Facsimilies and Power Supply Applications
- Applicable Frequency : 0.2 MHz to 30 MHz
- Low Profile In Vertical Core Layout
- UL940-V Recognized Materials
- Temperature Rise : 45°C Max.
- UL1446 Insulating System
- 2000 Vrms Isolation
- 4-Section Bobbin

### Electrical Parameters @ 25° C

Part Number	Inductance (mH Min.) [Pins 1-2, 4-3]	Current Rating (A rms Max.)
EPZ3059-541	.54	2.0
EPZ3059-901	0.9	1.5
EPZ3059-182	1.8	1.2
EPZ3059-272	2.7	0.9
EPZ3059-452	4.5	0.7
EPZ3059-722	7.2	0.6
EPZ3059-922	9.0	0.5

### Impedance Characteristics

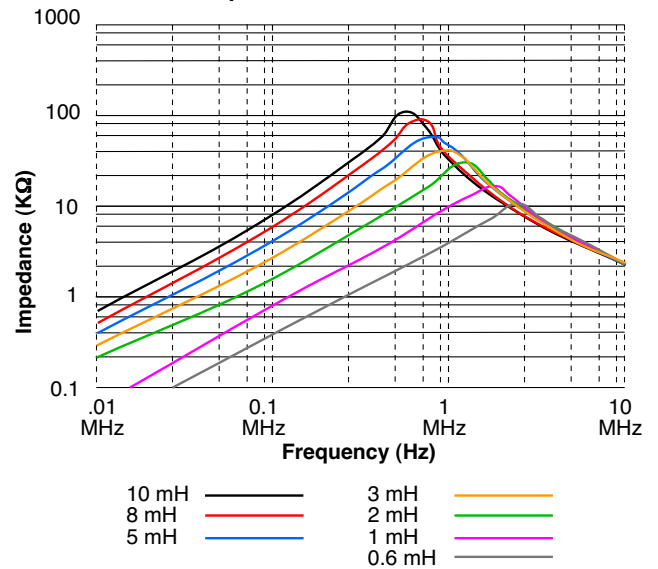

### Circuit Sample

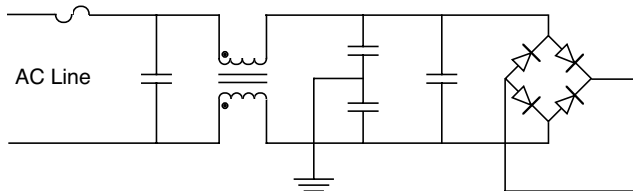

### Package

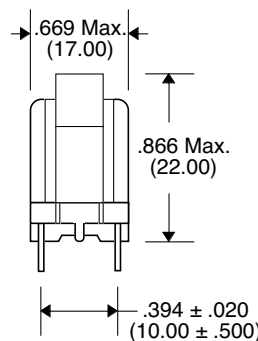
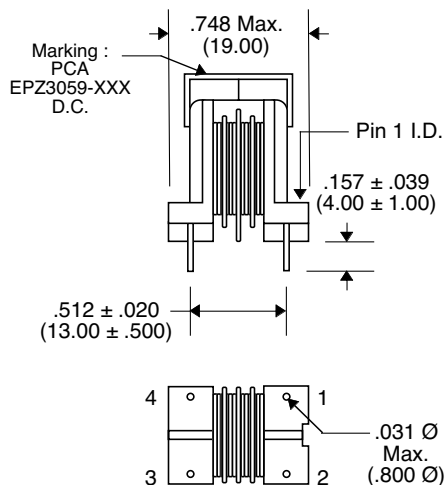

### Schematic

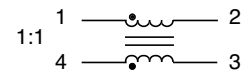

### Recommended PWB Piercing Plan

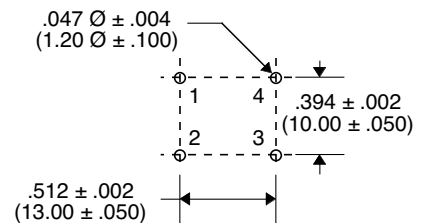

Unless Otherwise Specified Dimensions are in Inches /mm ± .010 / .25

# AC Power Line Choke EPZ3060LP-XXX

- Used as AC Power Line Filters in CTV, VTR, Audios, PC's, Facsimilies and Power Supply Applications
- Applicable Frequency : 0.1 MHz to 10 MHz
- Low Profile In Vertical Core Layout
- UL940-V Recognized Materials
- Temperature Rise : 60°C Max.
- UL1446 Insulating System
- 2000 Vrms Isolation
- 2-Section Bobbin

**Electrical Parameters @ 25° C**

Part Number	Inductance (mH Min.) [Pins 1-2, 4-3]	Current Rating (A rms Max.)
EPZ3060LP-152	1.5	2.0
EPZ3060LP-182	1.8	1.7
EPZ3060LP-222	2.2	1.5
EPZ3060LP-302	3.0	1.3
EPZ3060LP-352	3.5	1.2
EPZ3060LP-552	5.5	1.0
EPZ3060LP-742	7.4	0.8
EPZ3060LP-103	10	0.7
EPZ3060LP-123	12	0.6
EPZ3060LP-203	20	0.5
EPZ3060LP-303	30	0.4
EPZ3060LP-433	43	0.3

**Impedance Characteristics**

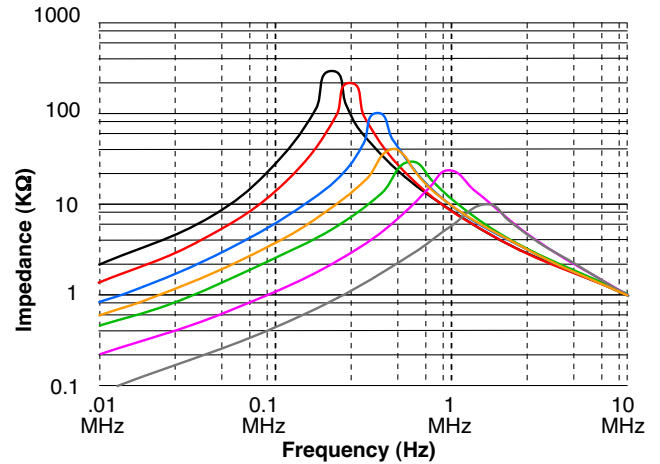

**Circuit Sample**

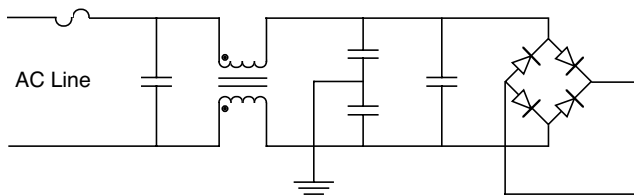

**Schematic**

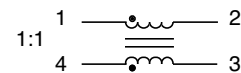

**Package**

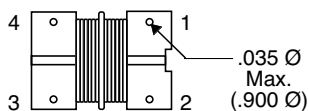
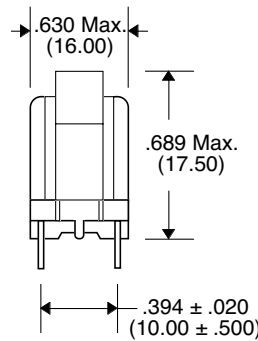
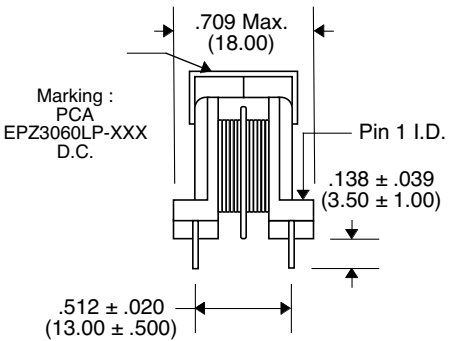

**Recommended PWB Piercing Plan**

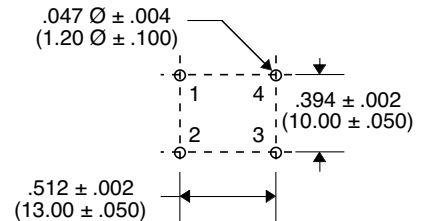

Unless Otherwise Specified Dimensions are in Inches /mm ± .010 /.25

# AC Power Line Choke EPZ3061LP-XXX

- Used as AC Power Line Filters in CTV, VTR, Audios, PC's, Facsimilies and Power Supply Applications
- Applicable Frequency : 0.2 MHz to 30 MHz
- Low Profile In Vertical Core Layout
- UL940-V Recognized Materials
- Temperature Rise : 60°C Max.
- UL1446 Insulating System
- 2000 Vrms Isolation
- 4-Section Bobbin

### Electrical Parameters @ 25° C

Part Number	Inductance (mH Min.) [Pins 1-2, 4-3]	Current Rating (A rms Max.)
EPZ3061LP-901	0.9	2.0
EPZ3061LP-132	1.3	1.7
EPZ3061LP-182	1.8	1.5
EPZ3061LP-202	2.0	1.3
EPZ3061LP-362	3.6	1.0
EPZ3061LP-772	7.7	0.7
EPZ3061LP-133	13	0.5
EPZ3061LP-223	22	0.4
EPZ3061LP-363	36	0.3

### Impedance Characteristics

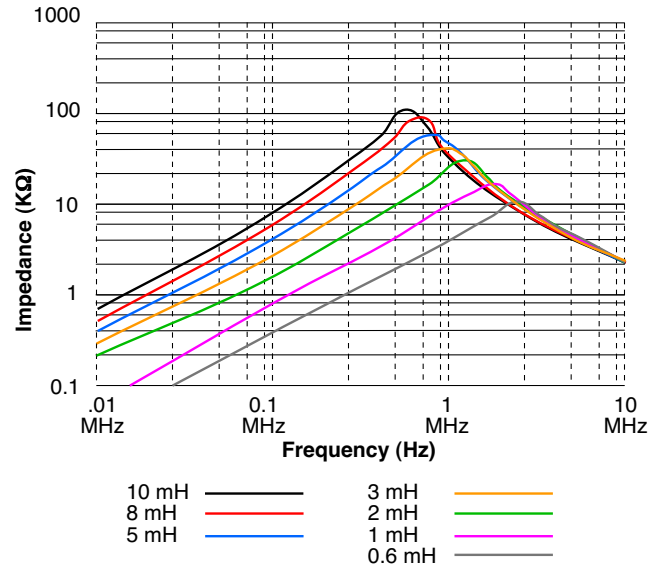

### Circuit Sample

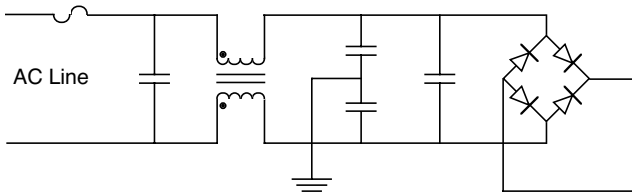

### Schematic

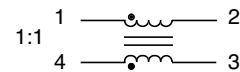

### Package

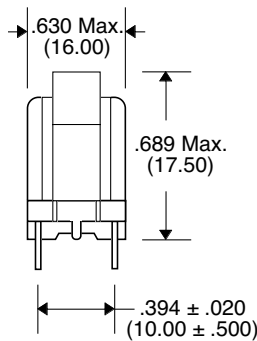
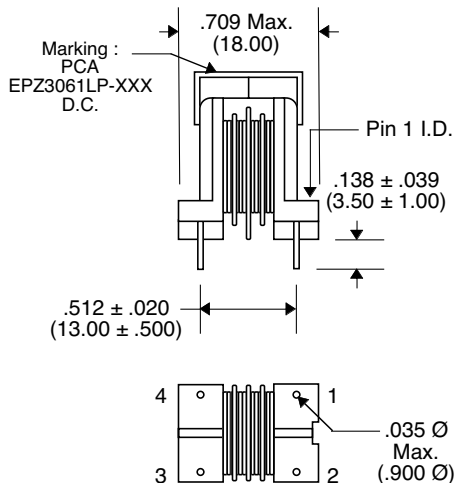

### Recommended PWB Piercing Plan

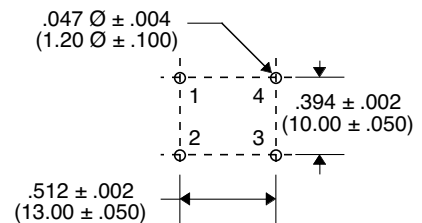

Unless Otherwise Specified Dimensions are in Inches /mm ± .010 / .25

- Used as AC Power Line Filters in CTV, VTR, Audios, PC's, Facsimilies and Power Supply Applications
- UL94V0 Recognized Materials
- Excellent for EMI Suppression
- UL1446 Insulating System
- High Current Ratings

### Electrical Parameters @ 25° C

Part Number	Inductance (mH)		Current Rating (A rms Max.)	DCR ( $\Omega$ Typ.)	Temp. Rise (Typ)
	[Pins 1-2, 4-3] Min.	Typ.			
EPZ3064-102	1.0	1.45	4.8	.019	35
EPZ3064-262	2.6	3.8	2.4	.076	35
EPZ3064-402	4.0	5.8	1.7	.144	34
EPZ3064-552	5.5	7.9	1.4	.206	33
EPZ3064-752	7.5	10.8	1.1	.367	35
EPZ3064-103	10.2	14.6	0.8	.666	34

• Isolation : 3750 Vrms •

### Typical Impedance Characteristics

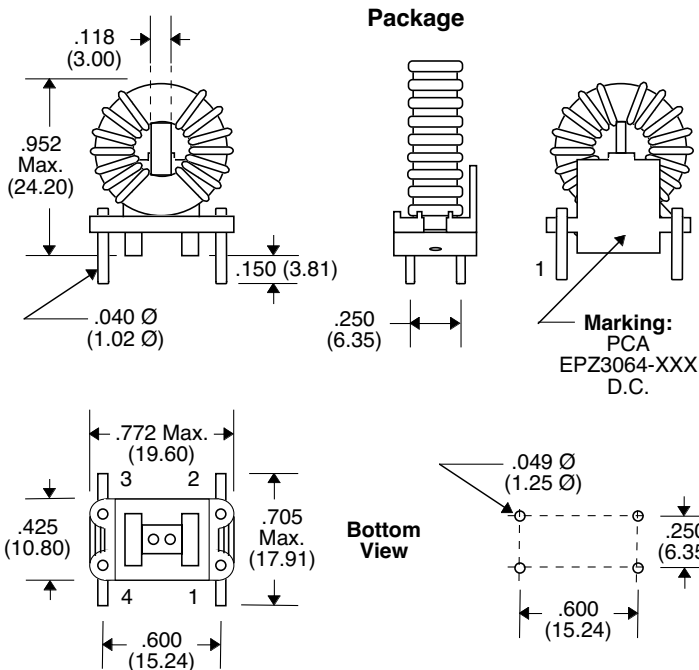
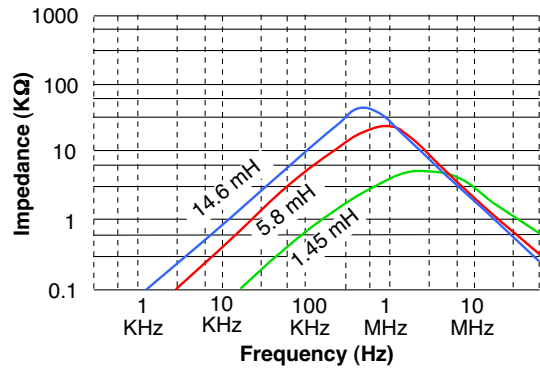

### Circuit Sample

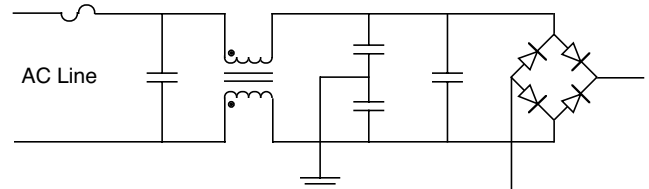

### Schematic

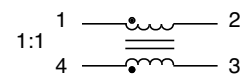

Unless Otherwise Specified Dimensions are in Inches /mm  $\pm .010 / .25$

- Used as AC Power Line Filters in CTV, VTR, Audios, PC's, Facsimilies and Power Supply Applications
- UL94V0 Recognized Materials
- Excellent for EMI Suppression
- UL1446 Insulating System
- High Current Ratings

### Electrical Parameters @ 25° C

Part Number	Inductance (mH)		Current Rating (A rms Max.)	DCR ( $\Omega$ Typ.)	Temp. Rise (Typ)
	[Pins 1-2, 4-3] Min.	Typ.			
EPZ3065-102	1.0	1.45	11	.008	34
EPZ3065-202	2.0	3.1	6.6	.022	36
EPZ3065-302	3.3	4.8	4.6	.044	35
EPZ3065-522	5.2	7.5	3.7	.070	36
EPZ3065-752	7.5	10.8	2.8	.123	36
EPZ3065-103	10.2	14.7	2.4	.168	36
EPZ3065-153	15.5	22.2	1.9	.267	36
EPZ3065-203	20	28.8	1.5	.380	33
EPZ3065-303	30	43.2	1.1	.743	34

• Isolation : 3750 Vrms •

### Typical Impedance Characteristics

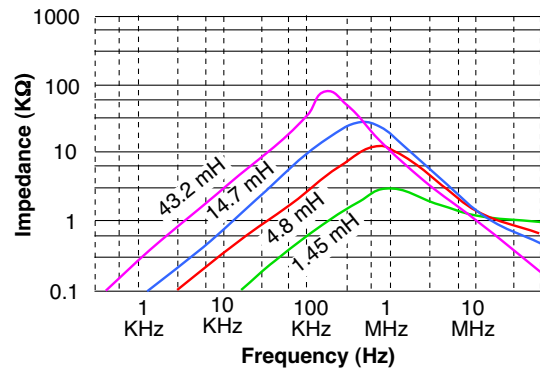

### Circuit Sample

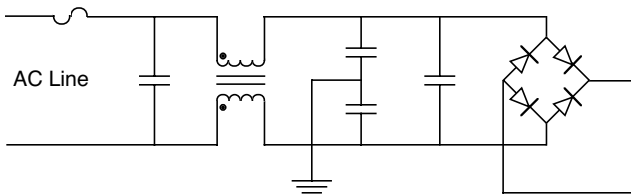

### Schematic

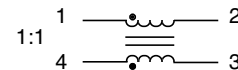

### Package

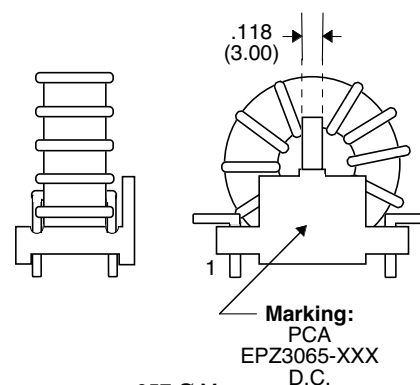
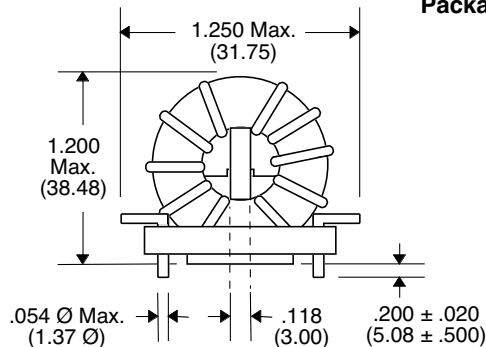

### Bottom View

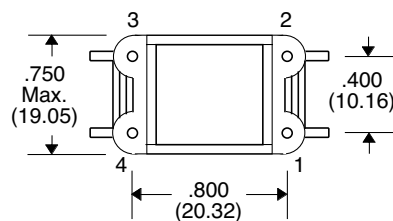

Unless Otherwise Specified Dimensions are in Inches /mm ± .010 / .25



## Contents LAN Common Mode Chokes

PCA Part No.	Inductance Range (mH)	Tolerance	Current	Length	Width	Height
EPA120	328	Min.	4	.280	.420	.175
EPA2163	85	Min.	2	.220	.280	.230
EPA2794	22.5	Min.	4	.470	.280	.230
EPA3308A	35	Min.	2	.195	.260	.150
EPA3308S	35	Min.	2	.215	.300	.160
EPA3393	2.0	Min.	3	.900	.400	.390
EPA3482	4.0	Min.	2 x 8	1.13	.490	.255
EPA3569S	36	Min.	2 x 4	.490	.270	.240
EPA3571	36	Min.	2	.220	.250	.220
EPT7003	5.0	Typ.	4	.230	.265	.180
EPT7003G	5.0	Typ.	4	.215	.300	.160
EPZ3022G	.033	Min.	---	.450	.265	.215
EPZ3027G	115	5%	---	.260	.170	.250
EPZ4000SE	5.0	Typ.	2	.240	.280	.160
EPZ4000SEM	5.0	Typ.	2	.299	.216	.102



# 4 Line Common Mode Filter

## EPA120 & EPA120G

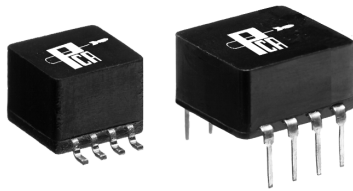

- Impedance limits per chart measured using HP4193A Vector Impedance Meter
- Package transfer-molded epoxy suitable for auto-insertion
- Part is symmetrical : May be inserted either way
- Temperature Rise 45°C Max. @ 25°C Ambient
- Maximum Current : 1 Adc/Winding
- Hipot : 300 Vac

### Schematic

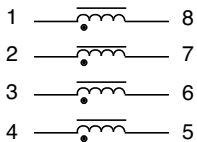

### Impedance Lower Limit

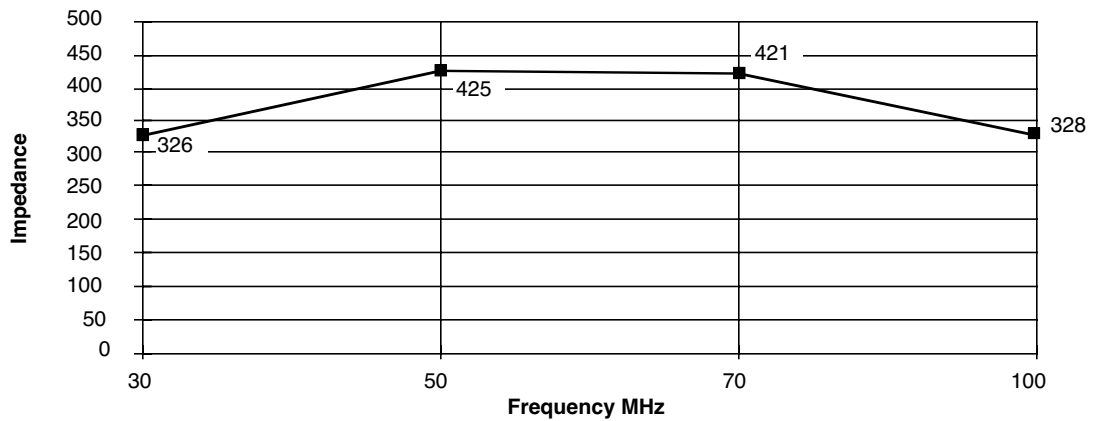

### DIP Package

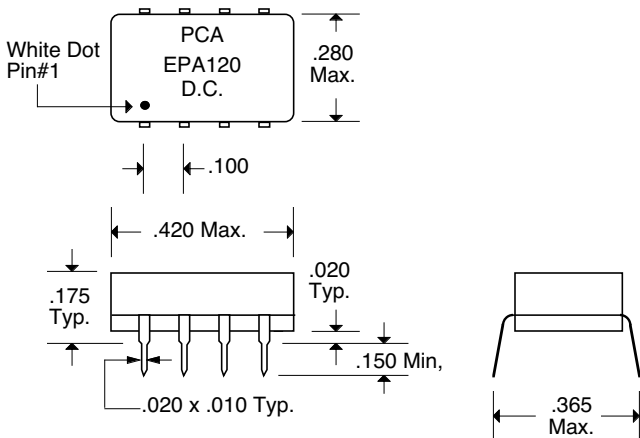

### SMD Package

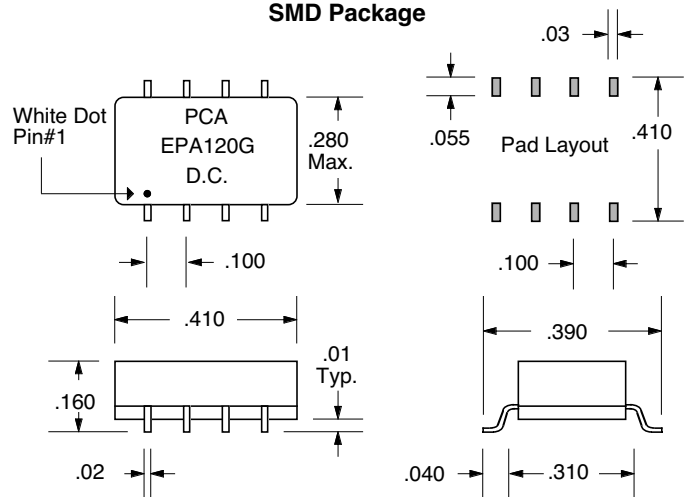

Unless Otherwise Specified Dimensions are in Inches /mm ±.010 /.25

## EPA2163



- Applications including FDDI-TP, Token Ring, Ethernet/10Base-T, ISDN, T1/CEPT/ISDN-PRI, and Fast Ethernet 10/100Base-T
- High impedance to minimize Common Mode Noise
- Complies with or exceeds IEEE Requirements
- Data Line Filters for EMI Noise Suppression

### Electrical Parameters @ 25° C

OCL ( $\mu$ H Min.)	Interwinding Capacitance (pF Max.)	Leakage Inductance ( $\mu$ H Max.)	DCR ( Max.)
@ 100 KHz, 0.1 Vrms	@ 100 KHz, 0.1 Vrms	@ 100 KHz, 0.1 Vrms	
85	12	0.25	0.20

### Schematic

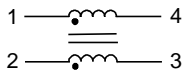

### Impedance Vs Frequency

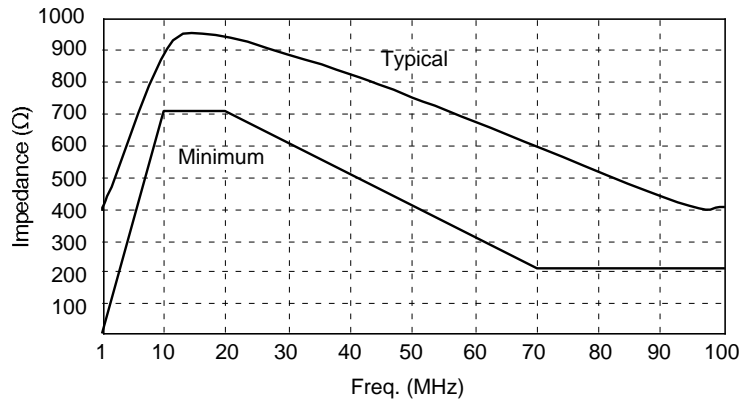

### Package

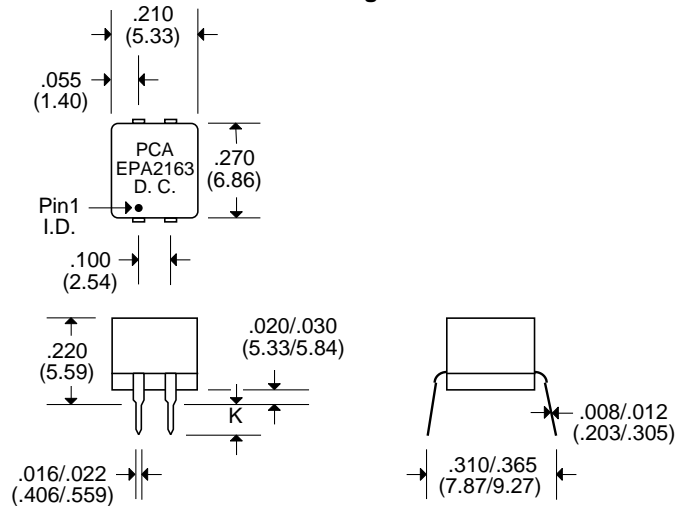

Unless Otherwise Specified Dimensions are in Inches /mm  $\pm .010 / .25$

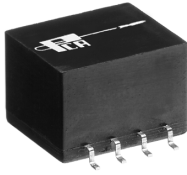

- Common Mode Filter Choke for Telecom Application
- Designed for 4-Wire Links, such as ISDN-S/T and T1/E1/CEPT
- High Frequency Chokes for EMI Reduction
- 500 Vrms Hipot

### Electrical Parameters @ 25° C

OCL ( $\mu$ H Min.)	Interwinding Capacitance (pF Max.)	Leakage Inductance ( $\mu$ H Max.)	DCR ( $\Omega$ Max.)
22.5	17	0.23	0.30

Typical Impedance

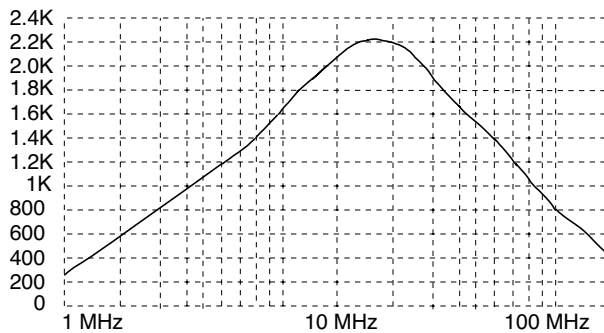

Typical Common Mode Attenuation

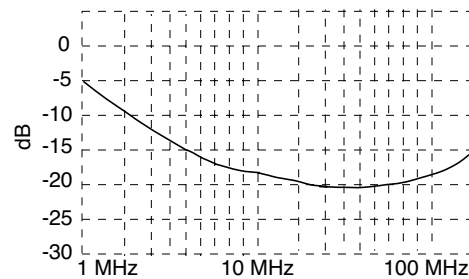

### Package

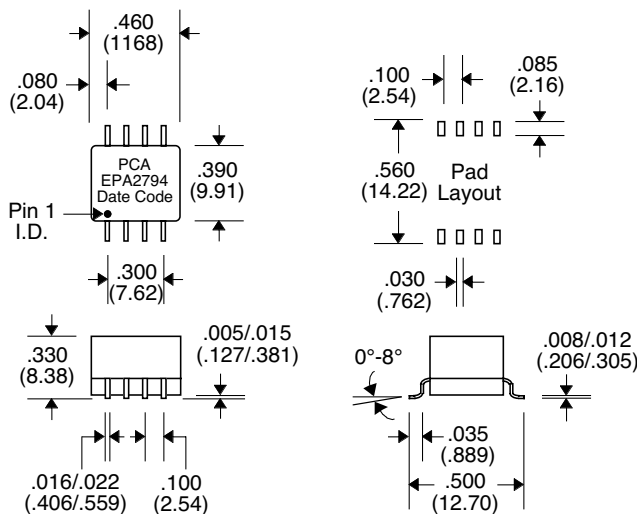

### Schematic

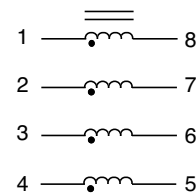

Unless Otherwise Specified Dimensions are in Inches /mm  $\pm$ .010 /.25

## EPA3308A

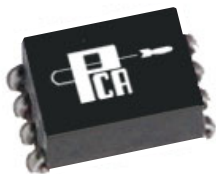

- Common Mode Choke for EMI Reduction
- Robust Construction to meet tough reflow process
- Rated Current : 500 mA
- 1500 Vrms Isolation

### Electrical Parameters @ 25° C

Primary Inductance ( $\mu$ H Min.)	Leakage Inductance ( $\mu$ H Max.)	DCR ( $\Omega$ Max.)
@ 100 KHz, 0.1 Vrms	@ 100 KHz, 0.1 Vrms	
35	.03	0.75

### Schematic

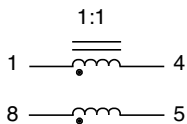

### Package

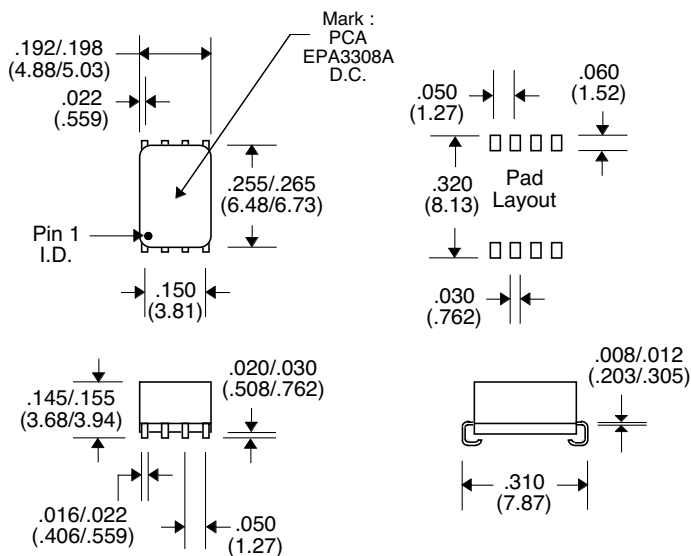

Unless Otherwise Specified Dimensions are in Inches /mm  $\pm .010 / .25$

## EPA3308S

- Common Mode Choke for EMI Reduction
- Robust Construction to meet tough reflow process
- Rated Current : 500 mA
- 1500 Vrms Isolation

### Electrical Parameters @ 25° C

Primary Inductance ( $\mu$ H Min.)	Leakage Inductance ( $\mu$ H Max.)	DCR ( $\Omega$ Max.)
@ 100 KHz, 0.1 Vrms	@ 100 KHz, 0.1 Vrms	
35	.03	0.75

### Schematic

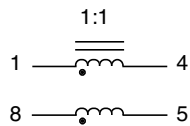

### Package

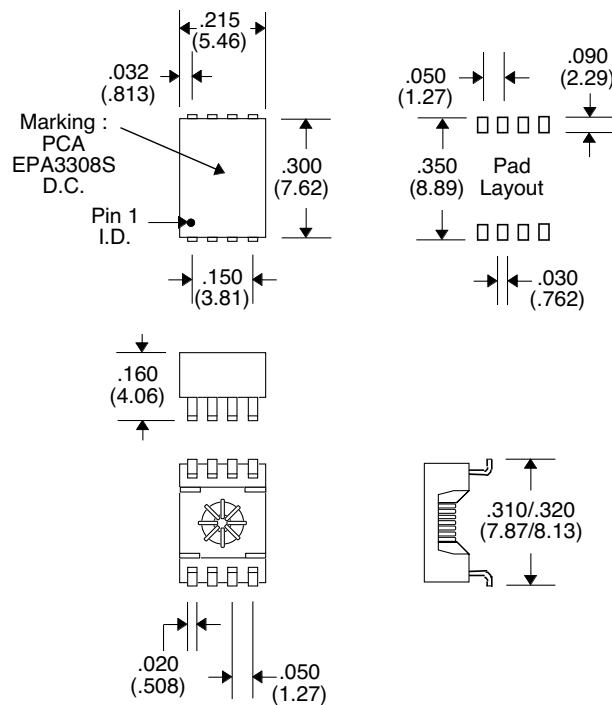

Unless Otherwise Specified Dimensions are in Inches /mm  $\pm$ .010 / .25

## EPA3393

- Greater or equal to 140  $\Omega$  impedance @ 1 GHz
- Material meets Class 130
- 1500 Vrms Isolation

### Electrical Parameters @ 25° C

OCL ( $\mu$ H Min.)	Interwinding Capacitance (pF Ref.)	Leakage Inductance ( $\mu$ H Ref.)	DCR ( $\Omega$ Max.)	Impedance ( $\Omega$ Min.)
@ 100 KHz, 0.1 Vrms	@ 100 KHz, 0.1 Vrms	@ 100 KHz, 0.1 Vrms		@ 1 GHz
2.0	1.3	0.08	0.01	140

### Typical Zp Graph

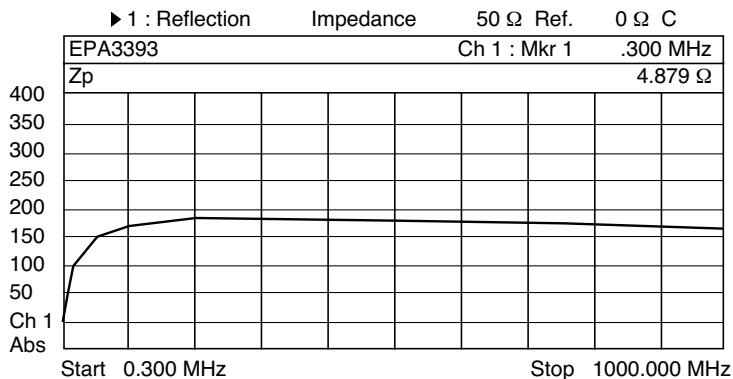

1 : Mkr	(MHz)	$\Omega$
1:	0.30	4.879
2:	1.00	10.75
3:	10.00	68.08
4:	50.00	139.3
5:	100.00	166.2
6:	200.00	180.3
7:	500.00	183.4
8:	1000.00	172.6

### Package

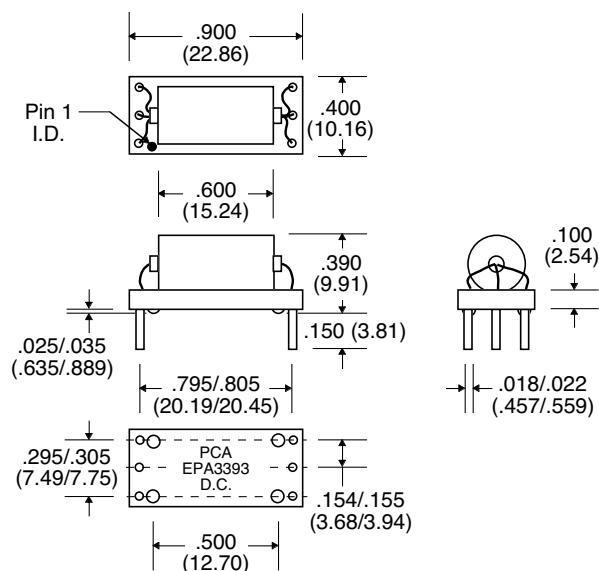

### Schematic

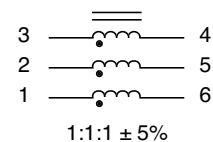

Unless Otherwise Specified Dimensions are in Inches /mm  $\pm$  .010 / .25

## EPA3482S

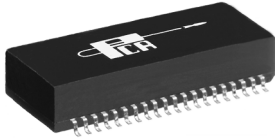

- Ideal for LAN Applications
- For use with 10Base-T, Token Ring and 100 MBPS
- High Frequency Choke for EMI Reduction

### Electrical Parameters @ 25° C

OCL ( $\mu$ H Min.)	Turns Ratio ( $\pm 1\%$ )	DCR ( $\Omega$ Max.)	Hipot (Vrms)
@ 100 KHz, 100m Vrms			for 1 minute
40	1:1	0.6	500

### Schematic

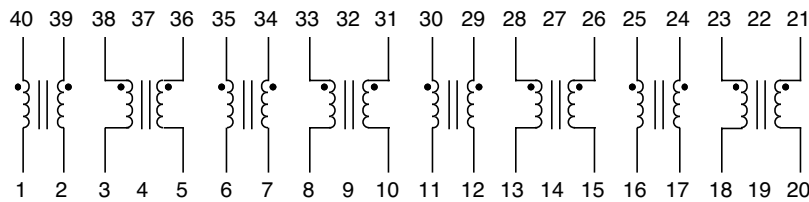

### Package

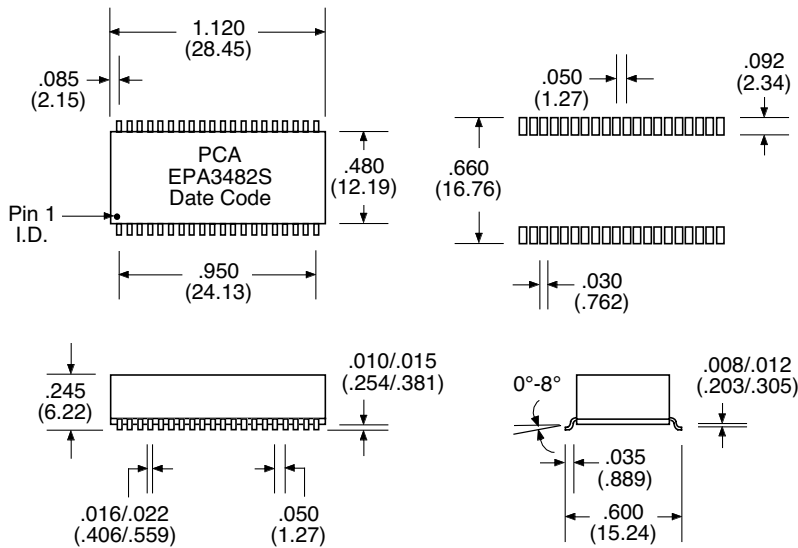

### Impedance Vs. Frequency

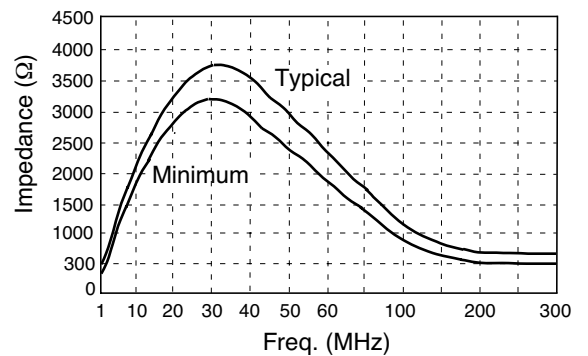

Unless Otherwise Specified Dimensions are in Inches /mm  $\pm .010 / .25$

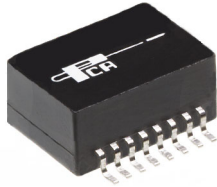

- Optimized for T1/E1 Applications
- Common Mode Choke for EMI Reduction

### Electrical Parameters @ 25° C

OCL ( $\mu$ H Min.)	Interwinding Capacitance (pF Max.)	Leakage Inductance ( $\mu$ H Max.)	DCR ( $\Omega$ Max.)
36	15	0.3	0.4

### Schematic

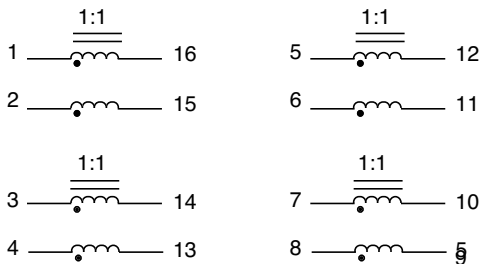

### Impedance Graph (deg $\Omega$ )



### Package

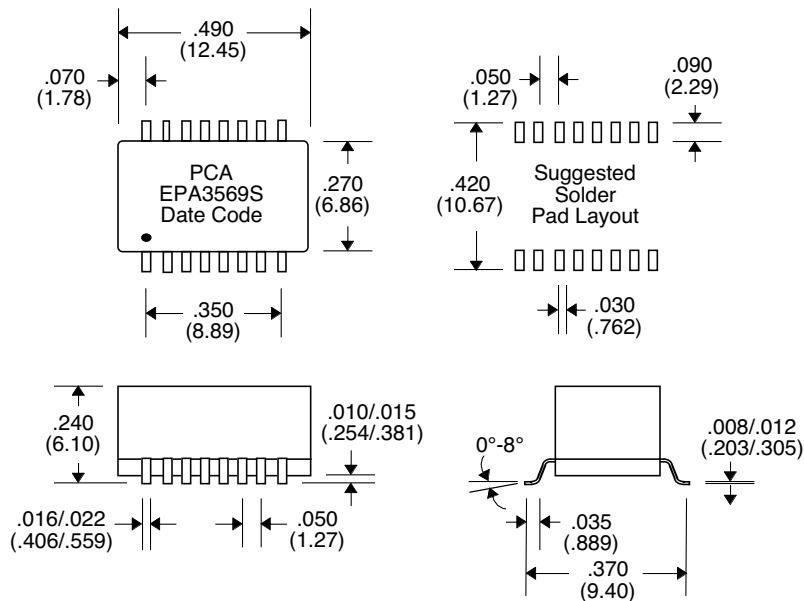

Unless Otherwise Specified Dimensions are in Inches /mm  $\pm .010 / .25$



## EPA3571G



- Common Mode Choke for EMI Reduction

### Electrical Parameters @ 25° C

OCL ( $\mu\text{H}$ Min.)	Interwinding Capacitance (pF Max.)	Leakage Inductance ( $\mu\text{H}$ Max.)	DCR ( $\Omega$ Max.)
36	15	0.3	0.4

### Schematic

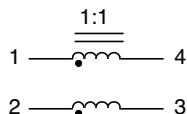

### Typical Common Mode Impedance ( $\Omega$ )

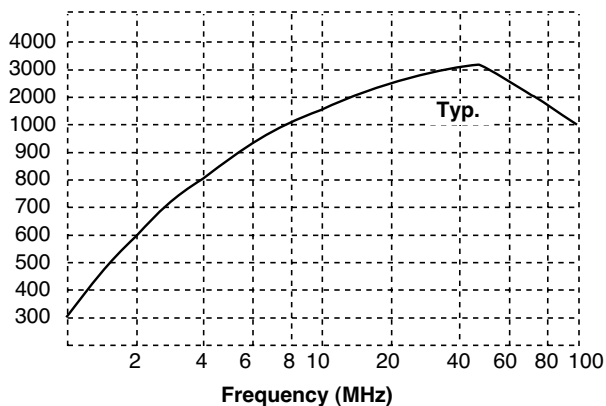

### Package

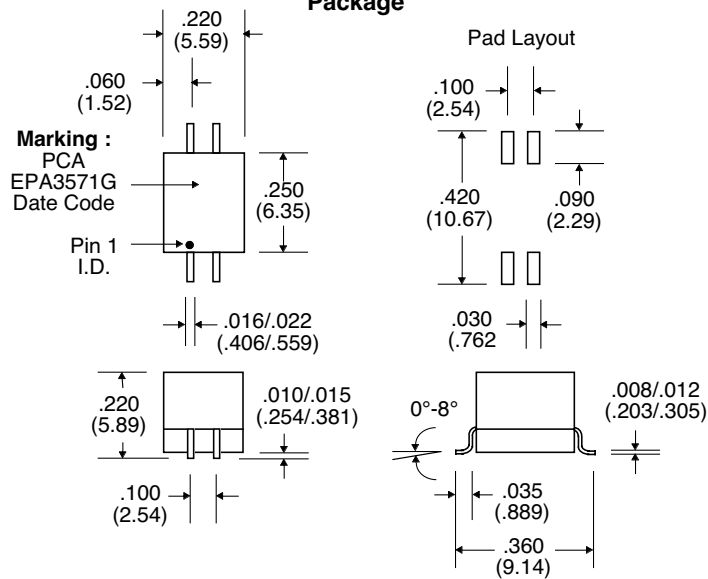

Unless Otherwise Specified Dimensions are in Inches /mm  $\pm .010 / .25$

## EPT7003



- Surface Mount Package
- Robust Construction for IR Processes
- Operating Temperature : 0°C to 85°C

### Electrical Parameters @ 25° C

Inductance ( $\mu$ H Typ.)	DCR ( $\Omega$ Max.)	Hipot (Vrms)	CMRR
@100 KHz, 100 m Vrms			
5.0	0.250	300	See Graph
Pins 1-8, 2-7, 3-6 and 4-5	Pins 1-8, 2-7, 3-6 and 4-5		

### Schematic

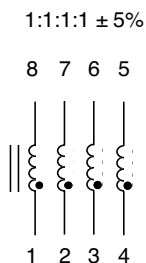

### Typical CMRR

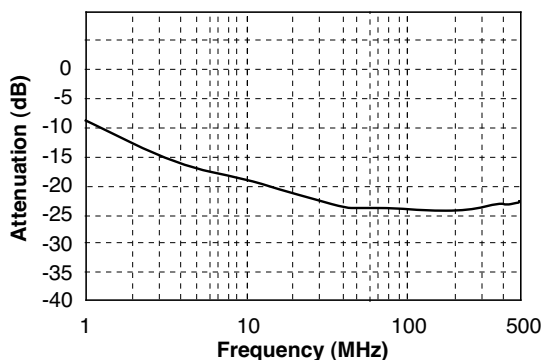

### Package

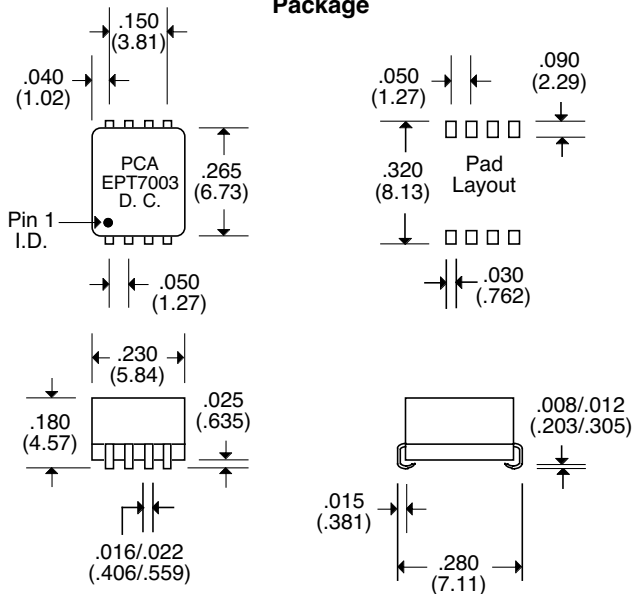

Unless Otherwise Specified Dimensions are in Inches /mm  $\pm$  .010 / .25

## EPT7003C & EPT7003C-RC



- Surface Mount Package
- Robust Construction for Reflow Processing
- Operating Temperature : 0°C to 85°C
- Peak Solder Rating (See Note 2)
- RoHS Compliant

### Electrical Parameters @ 25° C

Inductance (µH Min.)	DCR ( Max.)	Hipot (Vrms)	CMRR
@100 KHz, 100 m Vrms			
4.0	0.250	300	See Graph
Pins 1-8, 2-7, 3-6 and 4-5	Pins 1-8, 2-7, 3-6 and 4-5		

Notes :	EPT7003C	EPT7003C-RC
1. Assembly Process (Solder Composition)	SnPb	Pb-Free + (RoHS exemption 7a)
2. Peak Solder Rating (per IPC/JEDEC J-STD-020C)	225°C	260°C
3. Moisture Sensitive Levels (MSL) (per IPC/JEDEC J-STD-020C)	MSL = 3 (168 Hours, 30°C/60%RH)	MSL = 4 (72 Hours, 30°C/60%RH)
4. Weight	0.33 grams	0.33 grams
5. Packaging Information (*Add "TR" to end of part number when placing order)	1000 pieces/13" reel (*EPT7003C-TR)	1000 pieces/13" reel (*EPT7003C-RCTR)

### Schematic

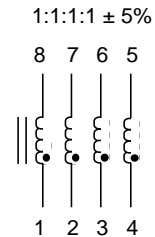

### Package

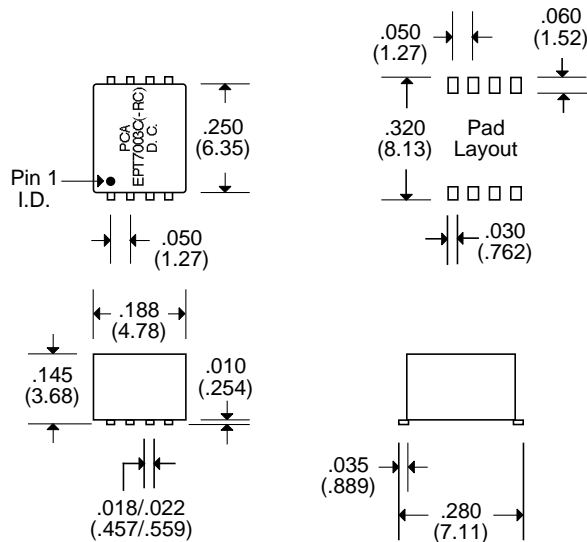

### Typical CMRR

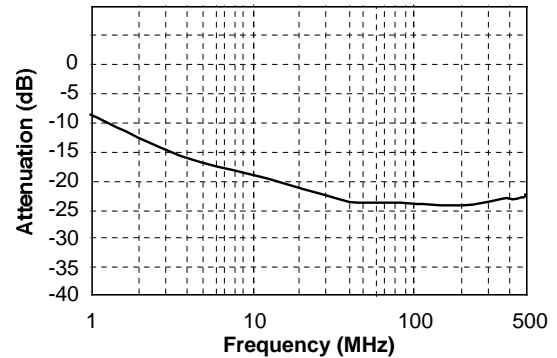

Unless Otherwise Specified Dimensions are in Inches /mm ± .010 / .25

## EPZ3022G

- Designed for 4-Wire Links, such as ISDN-S/T and T1/E1/CEPT
- High Frequency Chokes for EMI Reduction
- Operating Temperature : 0°C to +70°C

### Electrical Parameters @ 25° C

OCL ( $\mu$ H Min.) +25°C	Interwinding Capacitance (pF Max.)	Leakage Inductance ( $\mu$ H Max.)	Hipot (Vrms)	DCR ( $\Omega$ Max.)
@ 100 KHz, 0.1 Vrms	@ 100 KHz, 0.1 Vrms	@ 100 KHz, 0.1 Vrms		
33	20	0.3	500	0.2

### Schematic

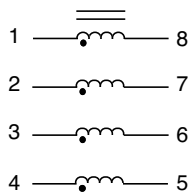

### Typical Common Mode Attenuation

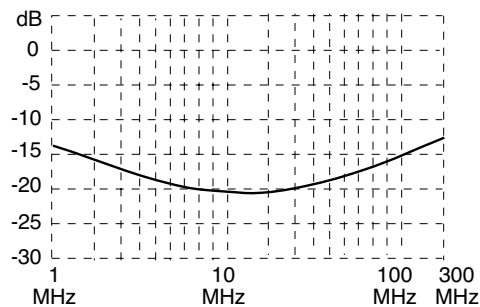

### Package

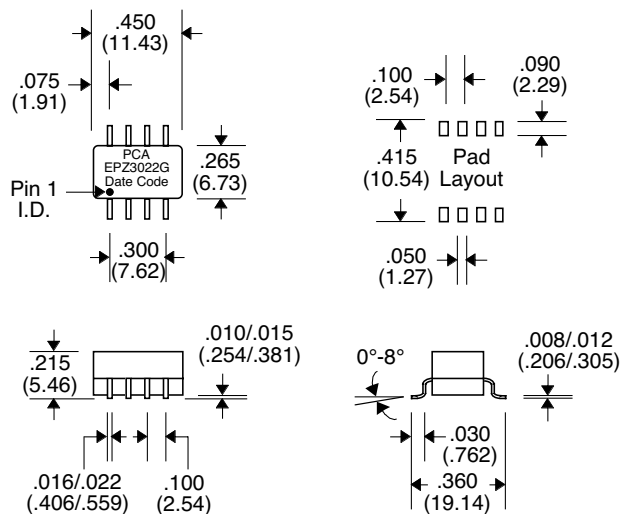

Unless Otherwise Specified Dimensions are in Inches /mm  $\pm .010 / .25$

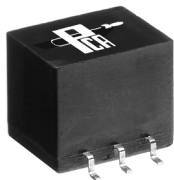

- Robust Construction allows for IR Processes
- Operating Temperature : 0°C to +70°C
- 6 Pin SMD Package

### Electrical Parameters @ 25° C

Inductance ( $\mu$ H Min.)	CMRR (dB Typ.)					DCR ( $\Omega$ Max.)
	@ 100 KHz	@ 1 MHz	@ 10 MHz	@ 100 MHz	@ 500 MHz	
@ 100 KHz, 100 mVrms	-4	-13	-19	-19	-14	0.095
115						
Pins 1-6, 2-5 & 3-4						

### Schematic

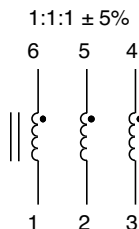

### Package

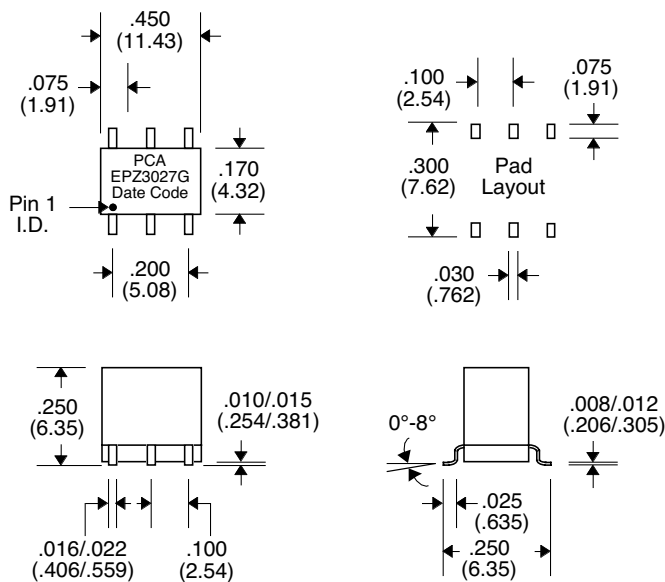

Unless Otherwise Specified Dimensions are in Inches /mm  $\pm$  .010 / .25

## EPZ4000SE

- Common Mode Attenuation : 200 MHz to 2.5 GHz
- Robust Construction allows for IR/VP processes
- Operating Temperature : -40°C to +85°C

### Electrical Parameters @ 25° C

OCL ( $\mu$ H Typ.)	DCR ( $\Omega$ Max.)
@ 100 KHz, 0.1 Vrms	
5	0.15

### Schematic

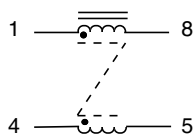

### Package

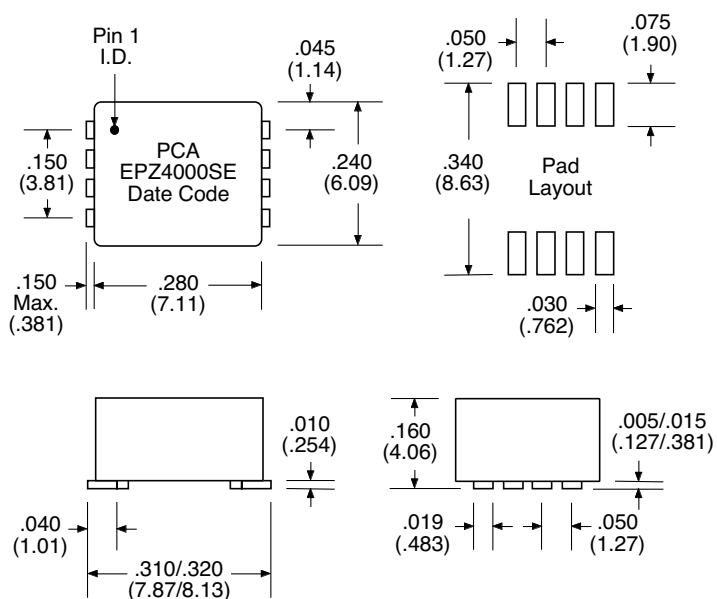

### Attenuation Vs Frequency

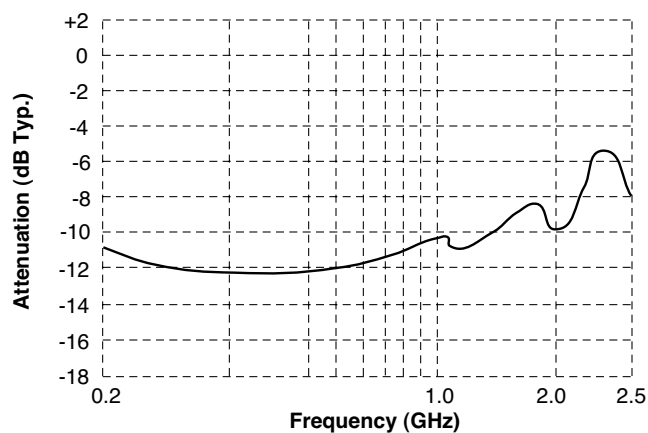

Unless Otherwise Specified Dimensions are in Inches /mm  $\pm .010 / .25$

## EPZ4000SME

- Common Mode Attenuation : 200 MHz to 2.5 GHz
- Robust Construction allows for IR/VP processes
- Operating Temperature : -40°C to +85°C

### Electrical Parameters @ 25° C

OCL ( $\mu$ H Typ.)	DCR ( $\Omega$ Max.)
@ 100 KHz, 0.1 Vrms	
5	0.15

### Schematic

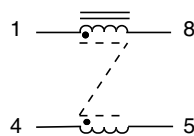

### Package

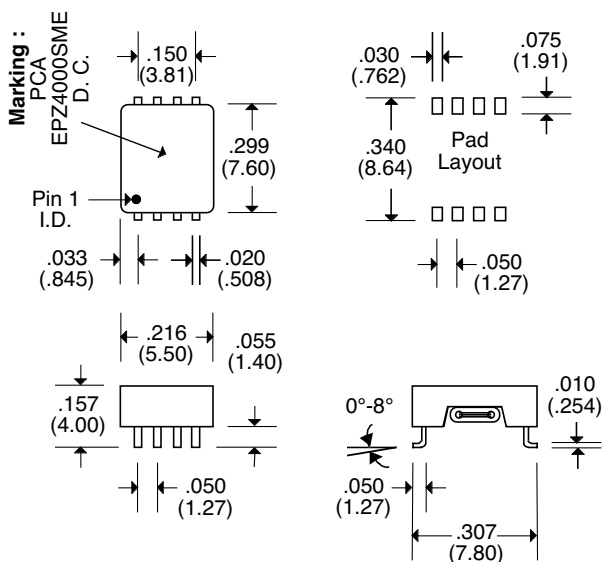

### Attenuation Vs Frequency

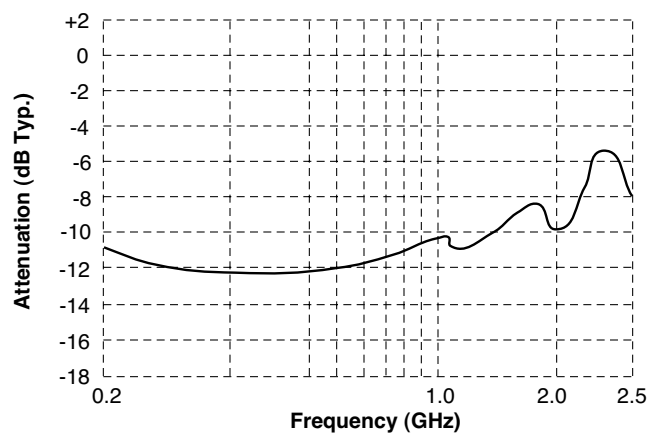

Unless Otherwise Specified Dimensions are in Inches /mm  $\pm .010 / .25$



## Contents DC Power Chokes

PCA Part No.	Inductance Range (mH)	Tolerance	Current	Length	Width	Height
EPZ3001G	3.0	Min.	2.5 A	.585	.720	.390
EPZ3002G	3.0	30%	2.5 A	.670	.770	.390
EPZ3003G	.0015	Min.	5.0 A	.275	.364	.234
EPZ3004G	1.17	25%	1.22 A	.500	.500	.215
EPZ3005G	.884	25%	1.63 A	.500	.500	.215
EPZ3006G	1.47	25%	2.80 A	.670	.770	.390
EPZ3007G	1.32	25%	3.30 A	.670	.770	.390
EPZ3008G	.225	25%	3.30 A	.670	.770	.390
EPZ3009G	.768	25%	4.70 A	.670	.770	.390
EPZ3010GE	.590	25%	5.60 A	.670	.770	.390
EPZ3011G	.530	25%	7.20 A	1.11	1.00	.390
EPZ3012G	.809	25%	9.70 A	1.22	1.00	.500
EPZ3013G	.630	25%	11.6 A	1.22	1.00	.500
EPZ3014G	.473	25%	14.0 A	1.22	1.00	.500
EPZ3023G	.003	25%	10.0 A	.450	.265	.215





- Noise Suppression Choke
- 2.5 A Max. Rated Current
- 500 Vrms Isolation

### Electrical Parameters @ 25° C

Inductance (mH Min.)	Inductance (mH Min.) @ 2 mA DC Bias	DCR (mΩ Max.)	Turns Ratio	SRF (MHz Typ. )	Temp. Rise @ 2.5 A (°C Typ. )
@10 KHz, 0.1 Vrms	@1 KHz, 0.1 Vrms	Matched with ± 5%			
3.0	2.4	.080	1 : 1	1.0	42
Pins 1-2, 3-4	Pins 1-2, 3-4	Pins 1-2, 3-4	Pins 1-2 : 3-4		

### Schematic

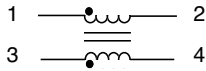

### Impedance (mp)

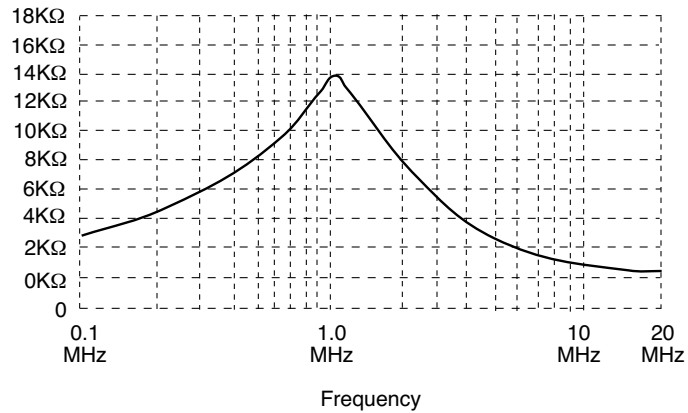

### Package

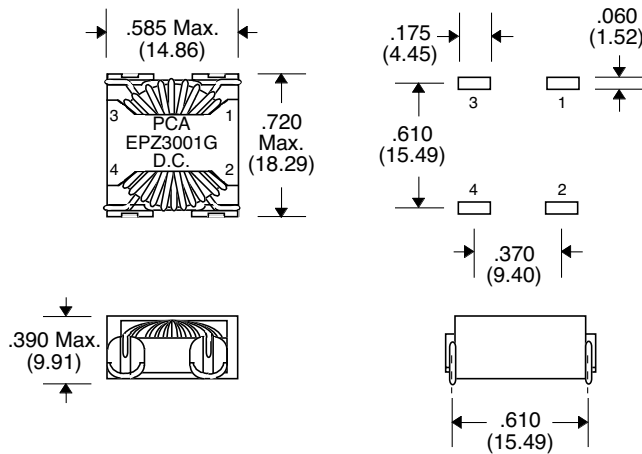

Unless Otherwise Specified Dimensions are in Inches /mm ± .010 / .25



- Noise Suppression Choke
- 2.5 A Max. Rated Current
- 500 Vrms Isolation

### Electrical Parameters @ 25° C

Inductance (mH ± 30%)	DCR (mΩ Max.)	Turns Ratio	SRF (MHz Typ. )	Temp. Rise @ 2.5 A (°C Typ. )
@10 KHz, 0.1 Vrms	Matched with ± 5%			
3.0	.080	1 : 1	1.5	37
Pins 1-2, 3-4	Pins 1-2, 3-4	Pins 1-2 : 3-4		

### Schematic

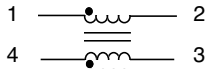

### Impedance (mp)

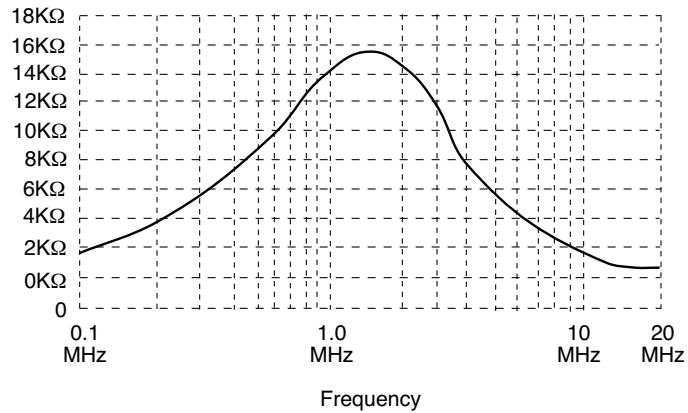

### Package

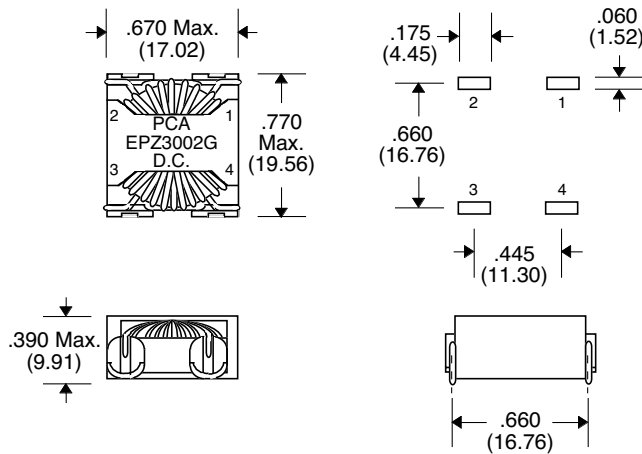

Unless Otherwise Specified Dimensions are in Inches /mm ± .010 / .25

- Noise Suppression Choke
- 5 A Max. Rated Current
- 250 Vrms Isolation

### Electrical Parameters @ 25° C

Inductance ( $\mu\text{H} \pm 30\%$ )	Impedance ( $\Omega$ Min. )	DCR ( $\text{m}\Omega$ Max.)	Turns Ratio	SRF (MHz Typ. )
	@100 MHz			
1.5	600	11	1 : 1	80
Pins 1-4, 2-3	Pins 1-4, 2-3	Pins 1-4, 2-3	Pins 1-4 : 2-3	

### Schematic

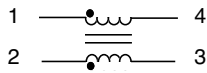

### Impedance Curve

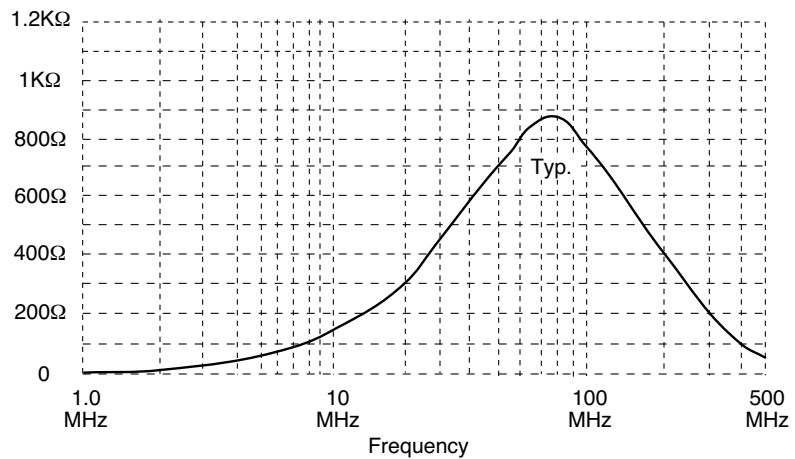

### Package

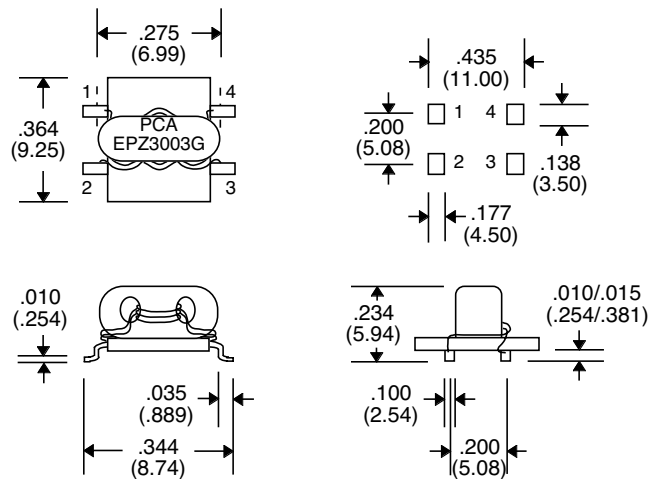

Unless Otherwise Specified Dimensions are in Inches /mm  $\pm .010 / .25$



- Noise Suppression Choke
- 1.22 A Max. Rated Current
- 500 Vrms Isolation

### Electrical Parameters @ 25° C

Inductance (mH ± 25%)	DCR (mΩ Max.)	Turns Ratio	SRF (MHz Typ. )	Temp. Rise @ 1.22 A (°C Typ. )
@10 KHz, 0.1 Vrms	Matched with ± 5%			
1.17	.200	1 : 1	3.0	37
Pins 1-2, 3-4	Pins 1-2, 3-4	Pins 1-2 : 3-4		

### Schematic

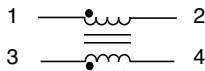

### Impedance Curve

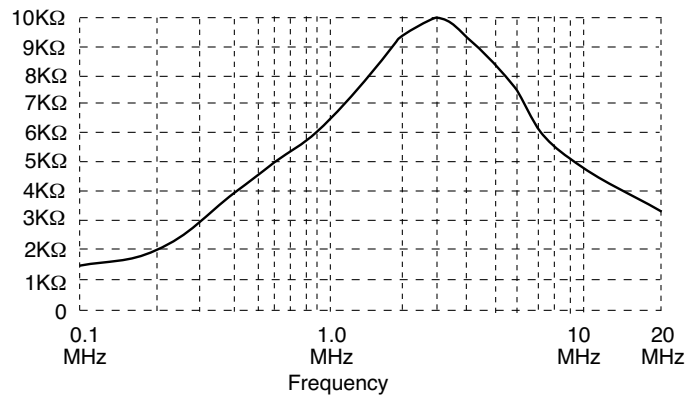

### Package

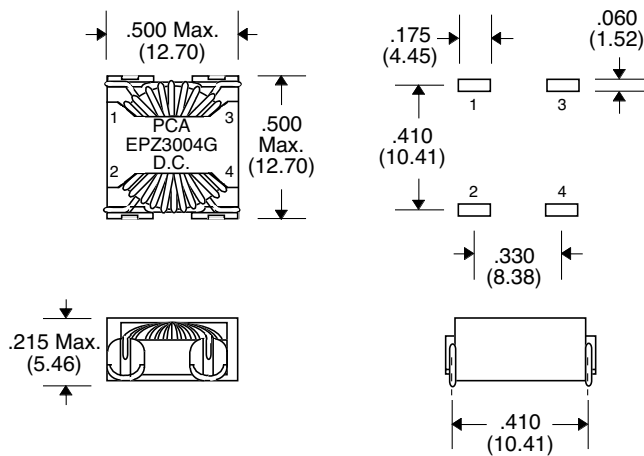

Unless Otherwise Specified Dimensions are in Inches /mm ± .010 / .25



- Noise Suppression Choke
- 1.63 A Max. Rated Current
- 500 Vrms Isolation

### Electrical Parameters @ 25° C

Inductance (mH ± 25%)	DCR (mΩ Max.)	Turns Ratio	SRF (MHz Typ. )
@10 KHz, 0.1 Vrms	Matched with ± 5%		
.884	110	1 : 1	4.0
Pins 1-2, 3-4	Pins 1-2, 3-4	Pins 1-2 : 3-4	

### Schematic

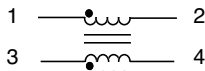

### Impedance Curve

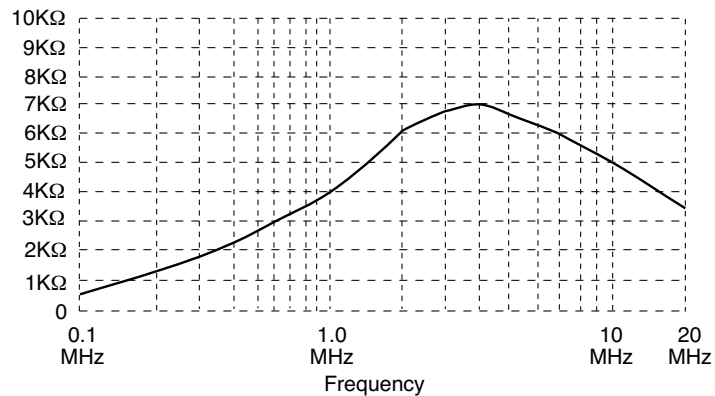

### Package

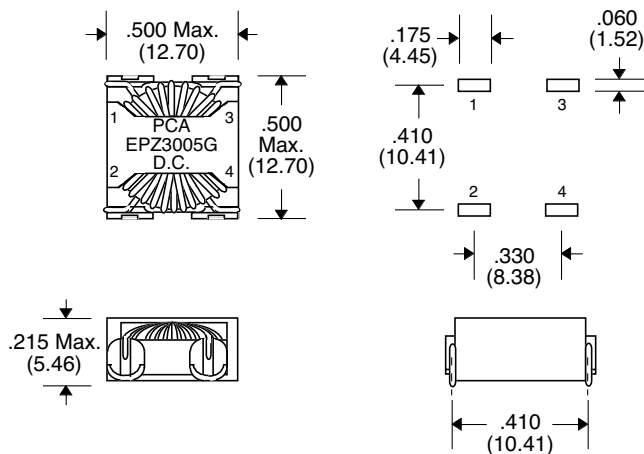

Unless Otherwise Specified Dimensions are in Inches /mm ± .010 / .25



- Noise Suppression Choke
- 2.80 A Max. Rated Current
- 500 Vrms Isolation

### Electrical Parameters @ 25° C

Inductance (mH ± 25%)	DCR (mΩ Max.)	Turns Ratio	SRF (MHz Typ.)
@10 KHz, 0.1 Vrms	Matched with ± 5%		
1.47	80	1 : 1	2.0
Pins 1-2, 3-4	Pins 1-2, 3-4	Pins 1-2 : 3-4	

### Schematic

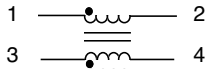

### Impedance Curve

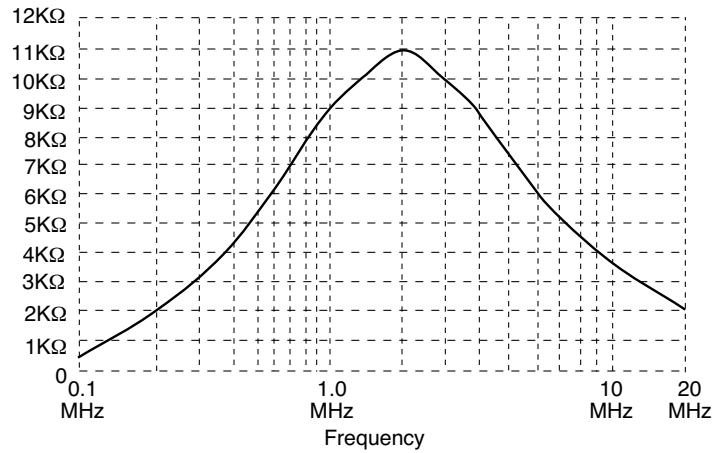

### Package

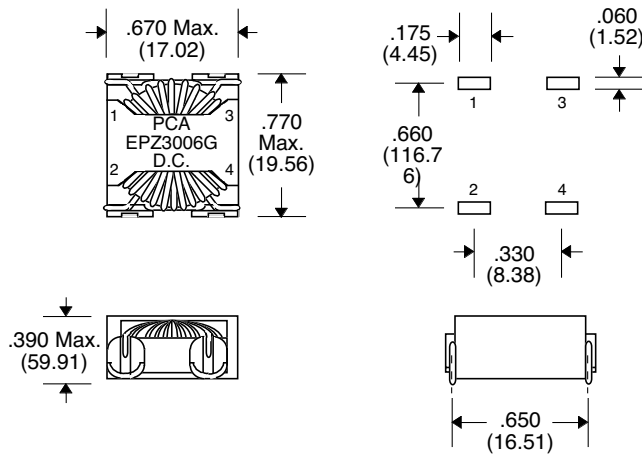

Unless Otherwise Specified Dimensions are in Inches /mm ± .010 / .25

## EPZ3007G



- Used in DC/DC Converter
- UL94V-0 Recognized Materials
- UL1446 Class B Insulating System
- Operating Temperature : -40°C to +85°C
- Noise suppression Choke
- 3.30 A Rated Current
- 500 Vrms Isolation

### Electrical Parameters @ 25° C

Inductance (mH ± 25%)	DCR (mΩ Max.)	Turns Ratio	SRF (MHz Typ. )
@10 KHz, 0.1 Vrms	Matched with ± 5%		
Pins 1-2, 3-4	Pins 1-2, 3-4	Pins 1-2 : 3-4	
1.32	60	1 : 1	2.0

### Schematic

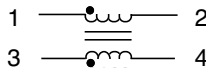

### Impedance Curve

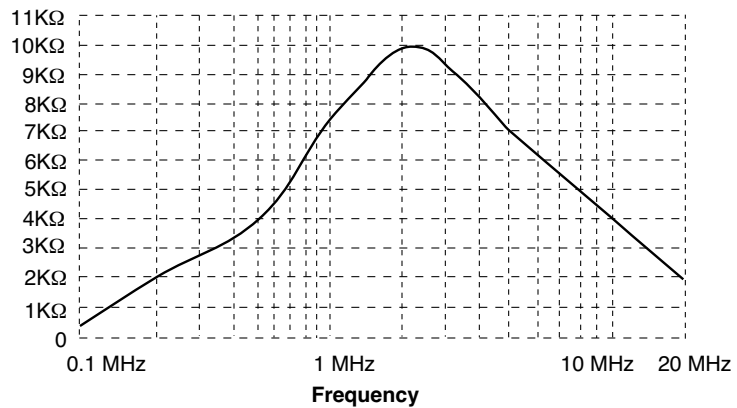

### Package

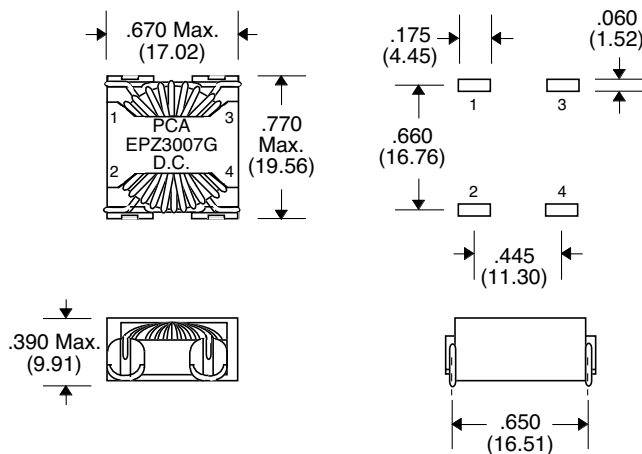

Unless Otherwise Specified Dimensions are in Inches /mm ± .010 / .25



- Noise Suppression Choke
- 3.30 A Max. Rated Current
- 500 Vrms Isolation

### Electrical Parameters @ 25° C

Inductance (mH ± 25%)	DCR (Ω Max.)	Turns Ratio	SRF (MHz Typ. )
@10 KHz, 0.1 Vrms	Matched with ± 5%		
.225	60	1 : 1	18
Pins 1-2, 3-4	Pins 1-2, 3-4	Pins 1-2 : 3-4	

### Schematic

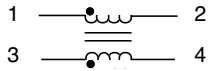

### Impedance Curve

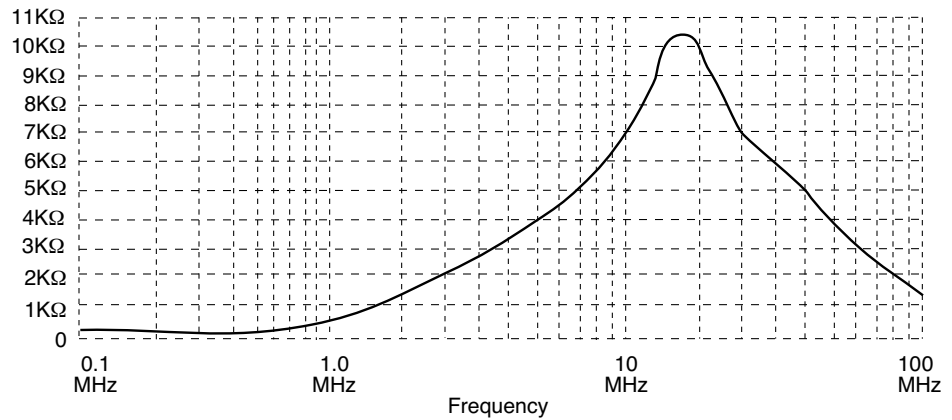

### Package

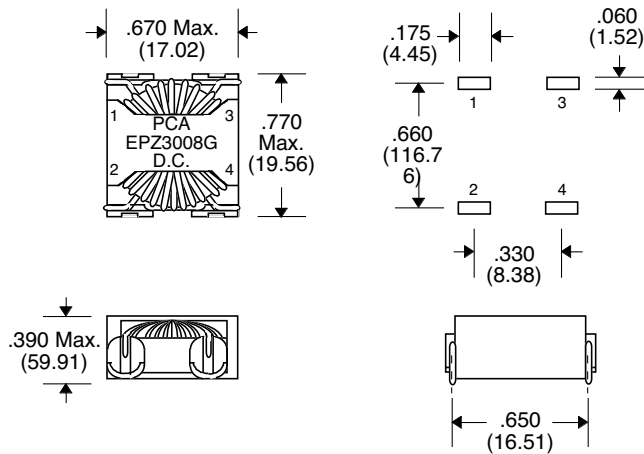

Unless Otherwise Specified Dimensions are in Inches /mm ± .010 / .25





- Used in DC/DC Converter
- UL 94V-0 Recognized Material
- UL 1446 Class B Insulation System
- Operating Temperature : -40°C to +85°C
- Noise suppression Choke
- 4.70 A Rated Current
- 500 Vrms Isolation

### Primary Specification

Inductance (mH $\pm$ 25%)	DCR (m $\Omega$ Max.)	Turns Ratio	SRF (MHz Typ. )
@10 KHz, 0.1 Vrms	Matched with $\pm$ 5%		
0.768	40	1 : 1	3.0
Pins 1-2, 3-4	Pins 1-2, 3-4	Pins 1-2 : 3-4	

### Schematic

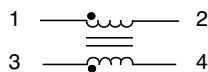

### Impedance Curve

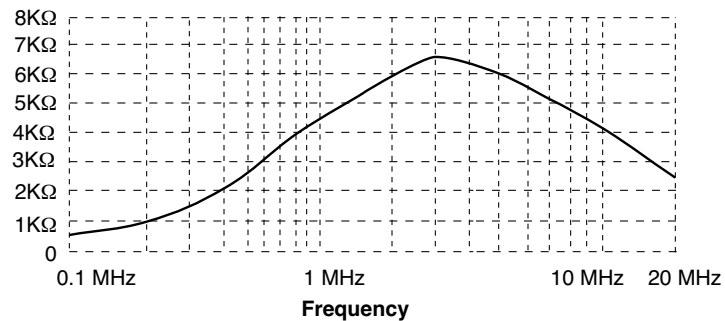

### Package

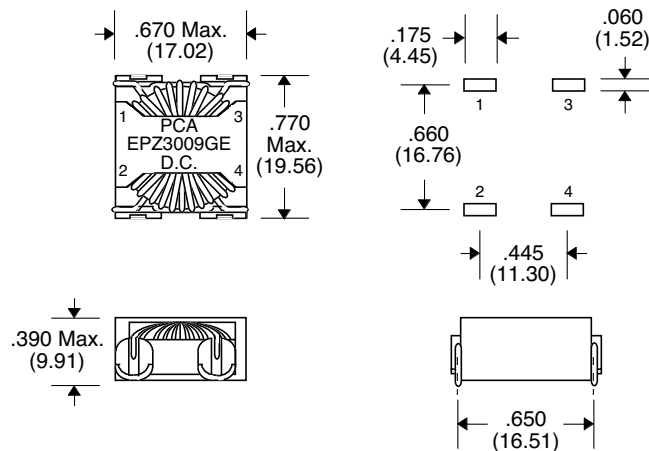

Unless Otherwise Specified Dimensions are in Inches /mm  $\pm$  .010 / .25



- Used in DC/DC Converter
- Noise suppression Choke
- 5.60 A Rated Current
- 1500 Vrms Isolation
- Operating Temperature : -40°C to 85°C

### Electrical Parameters @ 25° C

Inductance (mH $\pm$ 25%)	DCR (m $\Omega$ Max.)	Turns Ratio	SRF (MHz Typ. )
@10 KHz, 0.1 Vrms	Matched with $\pm$ 5%		
Pins 1-2, 3-4	Pins 1-2, 3-4	Pins 1-2 : 3-4	
0.590	20	1 : 1	4.0

**Impedance Curve**

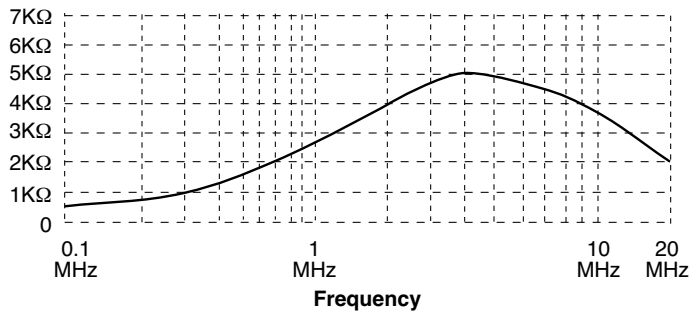

**Temperature Graph**

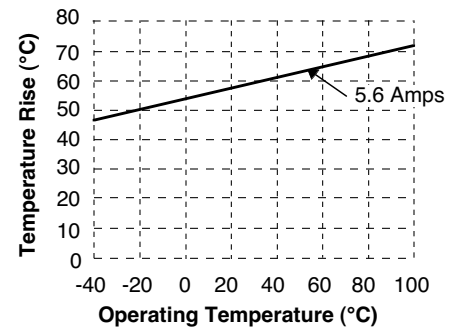

**Package**

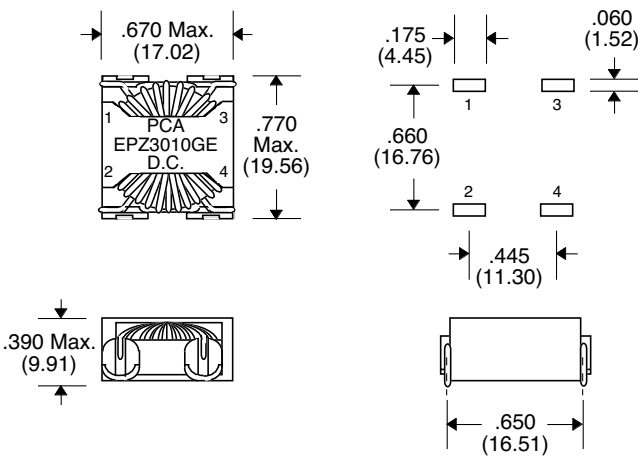

**Schematic**

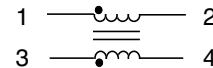

Unless Otherwise Specified Dimensions are in Inches /mm  $\pm$  .010 / .25

## EPZ3011G & EPZ3011G-LF



- Noise Suppression Choke
- 7.20 A Max. Rated Current
- Add "-LF" after part number for Lead Free
- 500 Vrms Isolation

### Electrical Parameters @ 25° C

Inductance (mH ± 25%)	DCR (m Max.)	Turns Ratio	SRF (MHz Typ. )
@10 KHz, 0.1 Vrms	Matched with ± 5%		
.530	15	1 : 1	4.0
Pins 1-2, 3-4	Pins 1-2, 3-4	Pins 1-2 : 3-4	

Notes :	EPZ3011G	EPZ3011G-LF
1. Assembly Process (Solder Composition)	SnPb	Pb-Free
2. Peak Solder Rating (per IPC/JEDEC-J-STD-020C)	225°C	260°C
3. Moisture Sensitive Levels (MSL) (per IPC/JEDEC-J-STD-020C)	1 (Unlimited, 30°C/60%RH)	1 (Unlimited, 30°C/60%RH)
4. Weight	TBD grams	TBD grams
5. Packaging Information (Tube)	TBD pcs / tube	TBD pcs / tube

### Schematic

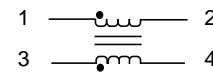

### Package

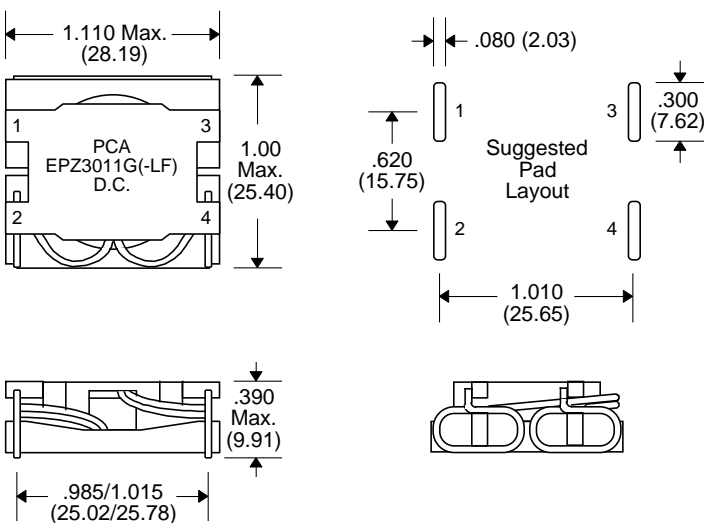

### Impedance Curve

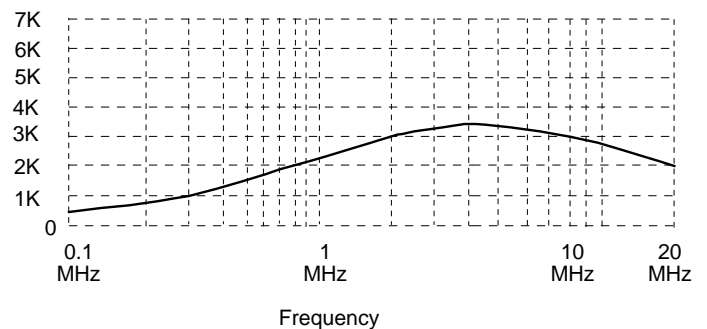

Unless Otherwise Specified Dimensions are in Inches /mm ± .010 / .25

## EPZ3012G & EPZ3012G-LF



- Noise Suppression Choke
- 9.70 A Max. Rated Current
- Add "-LF" after part number for Lead Free
- 500 Vrms Isolation

### Electrical Parameters @ 25° C

Inductance (mH ± 25%)	DCR (m Max.)	Turns Ratio	SRF (MHz Typ. )
@10 KHz, 0.1 Vrms	Matched with ± 5%		
.809	14	1 : 1	3.0
Pins 1-2, 3-4	Pins 1-2, 3-4	Pins 1-2 : 3-4	

Notes :	EPZ3012G	EPZ3012G-LF
1. Assembly Process (Solder Composition)	SnPb	Pb-Free
2. Peak Solder Rating (per IPC/JEDEC-J-STD-020C)	225°C	260°C
3. Moisture Sensitive Levels (MSL) (per IPC/JEDEC-J-STD-020C)	1 (Unlimited, 30°C/60%RH)	1 (Unlimited, 30°C/60%RH)
4. Weight	TBD grams	TBD grams
5. Packaging Information (Tube)	TBD pcs / tube	TBD pcs / tube

### Schematic

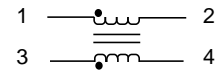

### Package

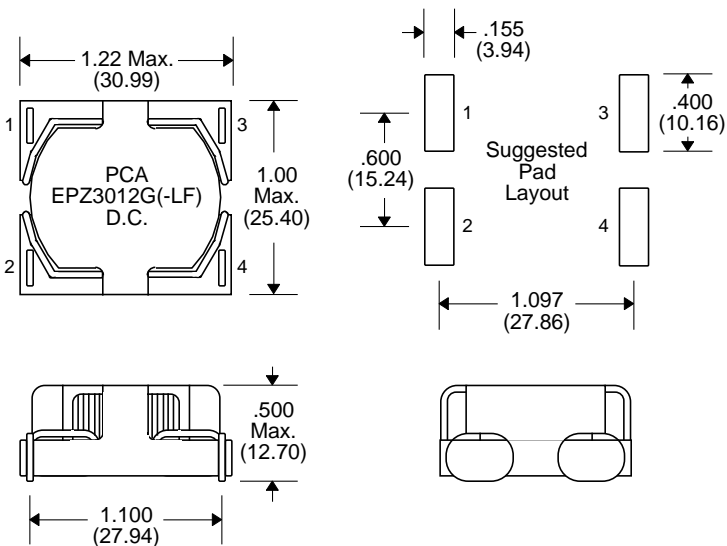

### Impedance Curve

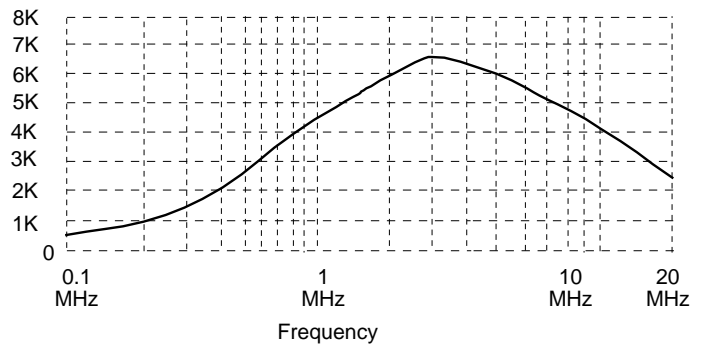

Unless Otherwise Specified Dimensions are in Inches /mm ± .010 / .25



- Noise Suppression Choke
- 11.6 A Max. Rated Current
- 500 Vrms Isolation

### Electrical Parameters @ 25° C

Inductance (mH ± 25%)	DCR (Ω Max.)	Turns Ratio	SRF (MHz Typ. )
@10 KHz, 0.1 Vrms	Matched with ± 5%		
.630	10	1 : 1	4.0
Pins 1-2, 3-4	Pins 1-2, 3-4	Pins 1-2 : 3-4	

### Schematic

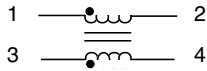

### Impedance Curve

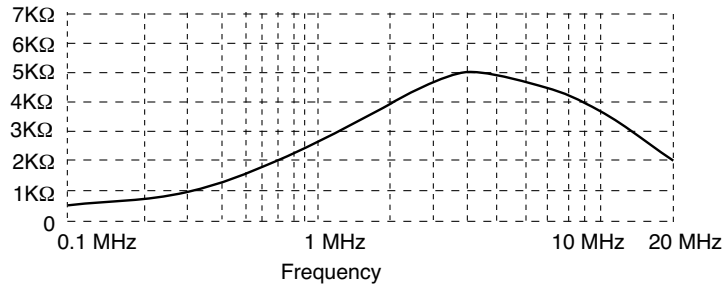

### Package

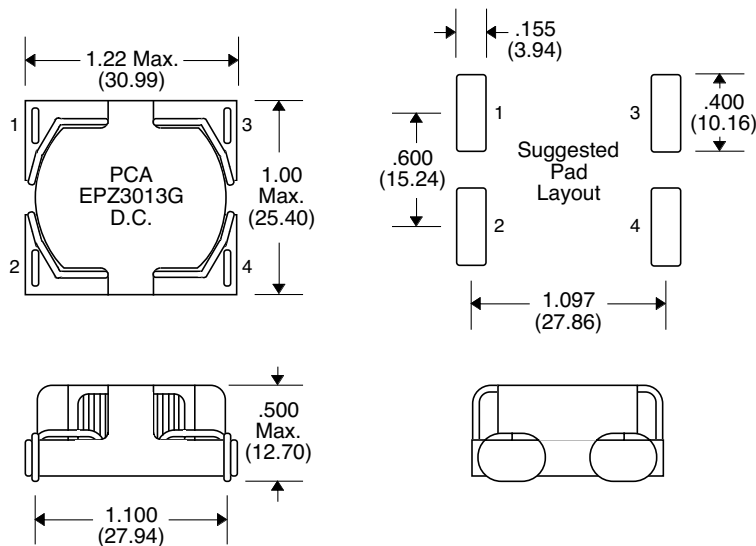

Unless Otherwise Specified Dimensions are in Inches /mm ± .010 / .25

## EPZ3023G

- High Frequency Chokes for EMI Reduction
- 10 A Continuous Maximum Current
- 40°C Maximum Temperature Rise

### Electrical Parameters @ 25° C

Impedance ( $\Omega$ Typ.)			Hipot (Vrms)	DCR ( $\Omega$ Max.)
@ 100 KHz	@ 500 KHz	@ 16 Hz		
130	270	230	250	.003

### Schematic

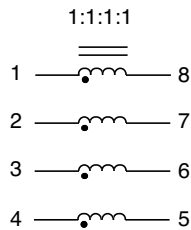

### Impedance Characteristic

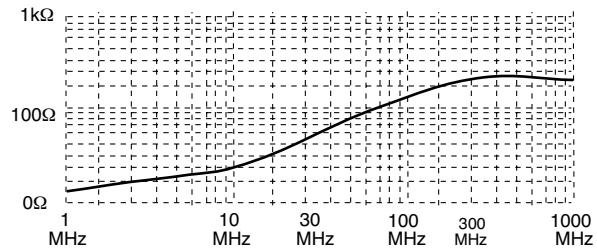

### Package

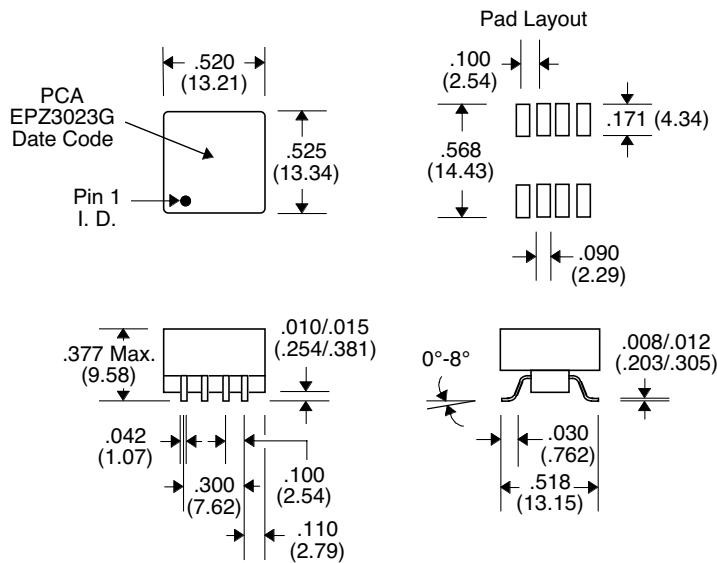

Unless Otherwise Specified Dimensions are in Inches /mm  $\pm .010 / .25$

## EPZ3014G & EPZ3014G-LF



- Noise Suppression Choke
- 14.0 A Max. Rated Current
- Add "-LF" after part number for Lead Free
- 500 Vrms Isolation

### Electrical Parameters @ 25° C

Inductance (mH ± 25%)	DCR (m Max.)	Turns Ratio	SRF (MHz Typ.)
@10 KHz, 0.1 Vrms	Matched with ± 5%		
.473	8.0	1 : 1	3.0
Pins 1-2, 3-4	Pins 1-2, 3-4	Pins 1-2 : 3-4	

Notes :	EPZ3014G	EPZ3014G-LF
1. Assembly Process (Solder Composition)	SnPb	Pb-Free
2. Peak Solder Rating (per IPC/JEDEC-J-STD-020C)	225°C	260°C
3. Moisture Sensitive Levels (MSL) (per IPC/JEDEC-J-STD-020C)	1 (Unlimited, 30°C/60%RH)	1 (Unlimited, 30°C/60%RH)
4. Weight	TBD grams	TBD grams
5. Packaging Information (Tube)	TBD pcs / tube	TBD pcs / tube

### Schematic

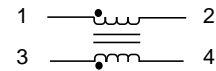

### Package

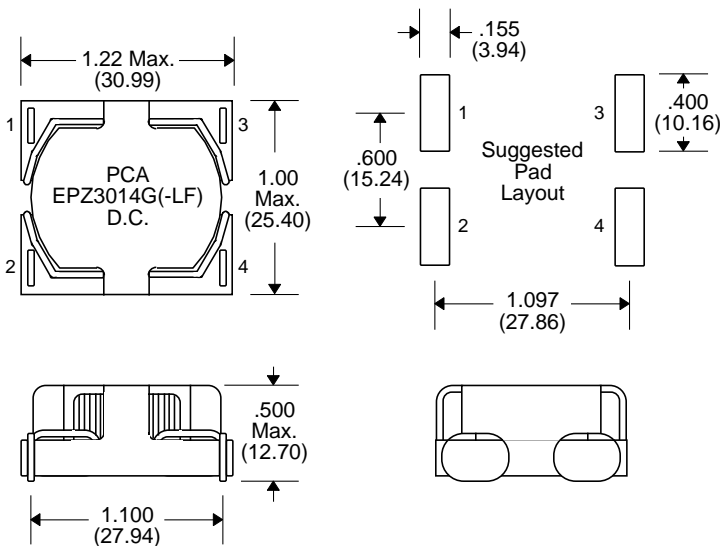

### Impedance Curve

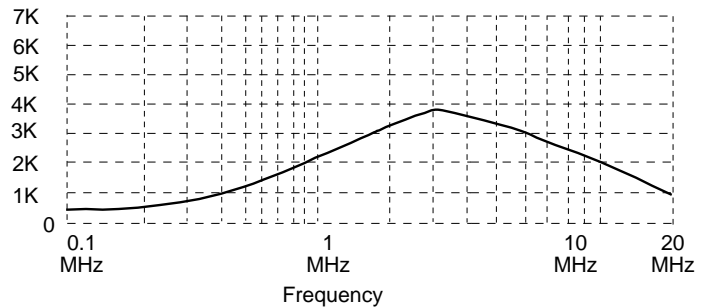

Unless Otherwise Specified Dimensions are in Inches /mm ± .010 / .25

Products and Applications:

Local Area Networking

Telecommunication

Broadband

Power Magnetics

Integrated Magnetics

Delay Lines

Custom Magnetics

In North America:

**PCA Electronics, Inc.**

16799 Schoenborn St.

North Hills, CA 91343

TEL: (888) 892-0761

(818) 892-0761

FAX: (818) 894-5791

WEB: [www.pca.com](http://www.pca.com)

Outside North America:

**HPC Limited**

26 Wong Chuk Hang Rd. 2nd Fl.

Aberdeen, Hong Kong

TEL: 011 852 2580 1878

FAX: 011 852 2870 2663



*Providing Magnetic Solutions Since 1950*