



# Evaluation Board for 12-bit high speed, low power, successive-approximation ADC

## EVAL-AD7492CB

### FEATURES

**Full-Featured Evaluation Board for the AD7492  
EVAL-CONTROL BRD2 Compatible  
Stand Alone Capability  
On-Board Analog Buffering and Reference  
Optional On-Board Analog Bias-Up Circuit  
Various Linking Options  
PC Software for Control and Data Analysis when used  
with EVAL-CONTROL BRD2**

### INTRODUCTION

This Technical Note describes the evaluation board for the AD7492 12-bit, high speed, low power, internal reference and clock, successive approximation A/D converter that operates from a single 2.7 V to 5.25 V supply. Full data on the AD7492 is available in the AD7492 data sheet available from Analog Devices and should be consulted in conjunction with this Technical Note when using the Evaluation Board.

On-board components include an AD780 which is a pin programmable +2.5 V or +3 V ultra high precision bandgap reference, two AD797 op-amps used to buffer the analog input, and an OP07 op-amp used to buffer the DC bias voltage applied to the optional analog input bias-up circuit. There are various link options which are explained in detail on page 2.

Interfacing to this board is through a 96-way connector. This 96-way connector is compatible with the EVAL-CONTROL BRD2 which is also available from Analog Devices. External sockets are provided for the  $\overline{\text{CONVST}}$  input and the VIN inputs.

### OPERATING THE AD7492 EVALUATION BOARD

#### Power Supplies

When using this evaluation board with the EVAL-CONTROL BRD2, all supplies are provided from the EVAL-CONTROL BRD2 through the 96 way connector.

When using the board as a stand alone unit, external supplies must be provided. This evaluation board has five power supply inputs:  $V_{DD}$ ,  $A_{GND}$ ,  $V_{SS}$ ,  $V_{DRIVE}$  and  $D_{GND}$ . +5 V must be connected to the  $V_{DD}$  input to supply the  $AV_{DD}$  and  $DV_{DD}$  pins on the AD7492, the AD780 voltage reference, the positive supply pin of all three op-amps and the digital control logic. 0 V is connected to the  $A_{GND}$  input. -5 V must be connected to the  $V_{SS}$  input to supply the negative supply pins on all three op-amps. The  $V_{DRIVE}$  input can be used to provide an external voltage for the output drivers on the AD7492. If an external  $V_{DRIVE}$  is supplied, it is referenced to the  $D_{GND}$  input which should be tied to 0 V. The supplies are decoupled to the relevant ground plane with 47 $\mu$ F tantalum and 0.1 $\mu$ F multilayer ceramic capacitors at the point where they enter the board. The supply pins of the op-amps and

### FUNCTIONAL BLOCK DIAGRAM

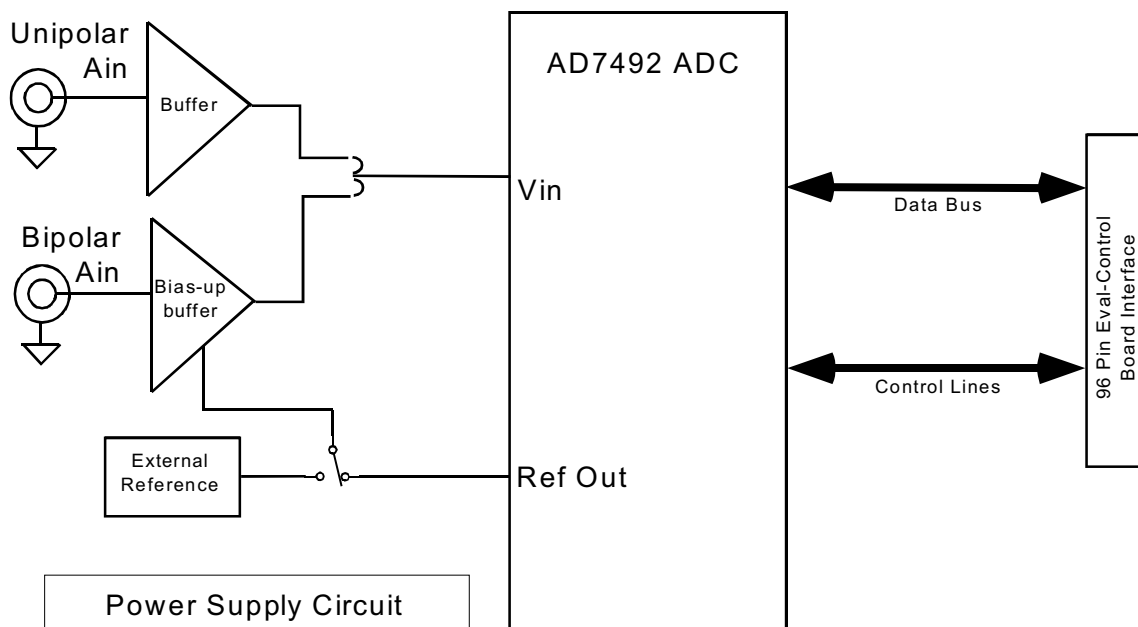

### REV. A

Information furnished by Analog Devices is believed to be accurate and reliable. However, no responsibility is assumed by Analog Devices for its use, nor for any infringements of patents or other rights of third parties which may result from its use. No license is granted by implication or otherwise under any patent or patent rights of Analog Devices.

# EVAL-AD7492CB

reference are also decoupled to  $A_{GND}$  with a 10 $\mu$ F tantalum and a 0.1 $\mu$ F ceramic capacitor. The AD7492  $AV_{DD}$  supply pin is decoupled to  $A_{GND}$  with 10 $\mu$ F tantalum and 0.1 $\mu$ F multilayer ceramic capacitors. The AD7492  $DV_{DD}$  and  $VDRIVE$  pins are decoupled to  $A_{GND}$  with 10 $\mu$ F tantalum capacitors and to  $D_{GND}$  with 0.1 $\mu$ F multilayer ceramic capacitors.

Extensive ground planes are used on this board to minimize the effect of high frequency noise interference. There are two ground planes,  $A_{GND}$  and  $D_{GND}$ . These are connected at one location close to the AD7492.

## Analog Input Section

The analog input section of this evaluation board accommodates unipolar and bipolar signals. Unipolar signals within the AD7492 analog input signal range of 0 V - 2.5 V are connected via SK1. They are then buffered by the on-board buffer before being applied to the  $VIN$  pin of the AD7492. Bipolar signals are connected via SK3 and are biased up by the on-board bias-up buffer circuit before being applied to the  $VIN$  pin of the AD7492. The input impedance of the bias-up circuit is 50 $\Omega$  which is determined by the value of R7. The input impedance may be modified by removing/changing the value of R7. To obtain optimum performance from this evaluation board the use of an impedance matched, passive filter is recommended before the analog signal is applied to the evaluation board. For example, when using a 100KHz input tone, a 100KHz 50 $\Omega$  filter from TTE (part number KC5-100K-15K-50/50-720B) is suitable.

## R13 Potentiometer (50Kohm)

This variable resistor is used to trim the DC bias voltage applied to the optional analog input bias-up circuit. This bias voltage is factory preset to 1.25 V which biases a bipolar signal to swing around the midpoint of the analog input range (0 - 2.5 V). If any adjustment is required, the user can use the histogram window in the eval-board software to analyze the DC voltage variation while adjusting the trim pot. To view this properly, an analog input signal should not be applied to the board. Under normal operation this pot should not be adjusted as it is preset for optimum performance.

## LINK AND SWITCH OPTIONS

There are 12 link options which must be set for the required operating setup before using the evaluation board. The functions of these options are outlined below.

### Link No.      Function.

- LK1      This link is used to select the DC bias voltage to be applied to the optional  $Vin$  bias-up circuit. If the user is using the bias-up circuit, this link must be inserted which will apply the 2.5 V reference voltage to the bias-up circuit. This causes a bipolar signal (applied to the bipolar  $vin$  input socket) to be biased up around +1.25 V before it is applied to the AD7492  $VIN$  pin. - see also LK10 (below).  
When this link is in position "A" the bias-up circuit is supplied by the AD7492 internal reference.  
When this link is in position "B" the bias-up circuit is supplied by the AD780 external reference.  
If the bias up circuit is not being used this link should be removed.
- LK2      This link must be in position "A" if external power supplies are being used. In this position the control logic is being powered by the voltage applied to the  $VDD$  input.  
When power is being supplied from the EVAL-CONTROL BRD2, this link can be moved to position "B" if the user wants to drive the control logic from a separate +5 V which is generated on the EVAL-CONTROL BRD2.
- LK3      This link option selects the sleep mode that the AD7492 can be put into.  
When this link is in position "A" the part goes into full sleep when low power operation is selected.  
When this link is in position "B" the part goes into partial sleep when low power operation is selected.
- LK4      This link option selects the source of the  $\overline{CONVST}$  input.  
When this link is in position "A" the  $\overline{CONVST}$  input is provided by the EVAL-CONTROL BRD2.  
When this link is in position "B" the  $\overline{CONVST}$  input is provided via the external socket, SK2.
- LK5      This link option selects the source of the  $\overline{RD}$  input.  
When this link is in position "A" the  $\overline{RD}$  input is provided by the EVAL-CONTROL BRD2.  
When this link is in position "B" the  $\overline{RD}$  input is tied to GND.
- LK6      This link option selects the source of the  $\overline{CS}$  input.  
When this link is in position "A" the  $\overline{CS}$  input is provided by the EVAL-CONTROL BRD2.  
When this link is in position "B" the  $\overline{CS}$  input is tied to GND.
- LK7      This link option sets the voltage applied to the  $VDRIVE$  pin on the AD7492.  
When this link is in position "A",  $VDRIVE$  is connected directly to the  $DVDD$  pin.  
When this link is in position "B", an external voltage must be applied to the  $VDRIVE$  pin Via J3.
- LK8      This link selects the source of the  $V_{DD}$  supply.  
When this link is in position "A"  $V_{DD}$  must be supplied from an external source via J2.  
When this link is in position "B"  $V_{DD}$  is supplied from the EVAL-CONTROL BRD2.
- LK9      This link selects the source of the  $V_{SS}$  supply.  
When this link is in position "A"  $V_{SS}$  must be supplied from an external source via J2.  
When this link is in position "B"  $V_{SS}$  is supplied from the EVAL-CONTROL BRD2.

Continued on next page

- LK10      This link must be in position "A" if a bipolar AIN signal is being applied to the bipolar Vin socket, SK3.  
This link must be in position "B" if a unipolar AIN signal is being applied to the unipolar Vin socket, SK1.
- LK11      This link is used to connect in the impedance matching resistor, R5, for unipolar Vin.
- LK12      This link is used to connect in the impedance matching resistor, R7, for bipolar Vin.

### SET-UP CONDITIONS

Care should be taken before applying power and signals to the evaluation board to ensure that all link positions are as per the required operating mode. Table I shows the position in which all the links are set when the evaluation board is sent out. All links are set for use with the EVAL-CONTROL BRD2.

**Table I. Initial Link and Switch Positions**

Link No.	Position	Function.
LK1	B	Provides DC bias voltage to the analog bias-up circuit using AD780 external reference.
LK2	B	The digital logic circuitry is powered from the EVAL-CONTROL BRD2.
LK3	B	Part goes into partial sleep mode if low power operation selected.
LK4	A	$\overline{\text{CONVST}}$ signal is provided by the EVAL-CONTROL BRD2 via J1.
LK5	A	$\overline{\text{RD}}$ signal is provided by the EVAL-CONTROL BRD2 via J1.
LK6	A	$\overline{\text{CS}}$ signal is provided by the EVAL-CONTROL BRD2 via J1.
LK7	A	AD7492 VDRIVE pin is connected to the AD7492 DVDD pin.
LK8	B	$V_{\text{DD}}$ is supplied by the EVAL-CONTROL BRD2 via J1.
LK9	B	$V_{\text{SS}}$ is supplied by the EVAL-CONTROL BRD2 via J1.
LK10	A	The AD7492 Vin pin is connected to the bipolar Vin.
LK11	Inserted	Unipolar Vin impedance matching resistor is connected into circuit.
LK12	Inserted	Bipolar Vin impedance matching resistor is connected into circuit.

# EVAL-AD7492CB

## EVAL-CONTROL BRD2 INTERFACING

Interfacing to the EVAL-CONTROL BRD2 is via a 96-way connector, J1. The pinout for the J1 connector is shown in Figure 2 and its pin designations are given in Table II.

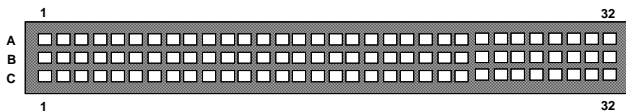

Figure 1. Pin Configuration for the 96-Way Connector, J1

### 96-Way Connector Pin Description

- D0-D11 Data Bit 0 to Data Bit 11. Three-state TTL outputs. D11 is the MSB.
- +5VD Digital +5 V supply. This can be used to provide a separate +5 V supply for the digital logic if required via LK2.
- $\overline{RD}$  Read. This is an active low logic input connected to the  $\overline{RD}$  pin of the AD7492 via LK5.
- $\overline{CS}$  Chip Select. This is an active low logic input connected to the  $\overline{CS}$  pin of the AD7492 via LK6.
- FL0 Flag zero. This logic input is connected to the  $\overline{CONVST}$  input of the AD7492 via LK4.
- $\overline{IRQ2}$  Interrupt Request 2. This is a logic output and is connected to the BUSY logic output on the AD7492.
- DGND Digital Ground. These lines are connected to the digital ground plane on the evaluation board. It allows the user to provide the digital supply via the connector along with the other digital signals.
- AGND Analog Ground. These lines are connected to the analog ground plane on the evaluation board.
- AV<sub>SS</sub> Negative Supply Voltage. This provides a negative supply to the on-board op-amps via LK9.
- AV<sub>DD</sub> Positive Supply Voltage. This provides a positive supply to the op-amps, the reference, the AD7492 and the digital logic.

When interfacing directly to the EVAL-CONTROL BRD2, all power supplies and control signals are generated by the EVAL-CONTROL BRD2. However, due to the nature of the DSP interface on the EVAL-CONTROL BRD2, AD7492 sampling rates greater than 750 KHz are not supported when interfacing the EVAL-AD7492CB directly to the EVAL-CONTROL BRD2.

Table II. 96-Way Connector Pin Functions.

	ROW A	ROW B	ROW C
1			
2		D0	
3		D1	
4	DGND	DGND	DGND
5		D2	
6		D3	
7		D4	
8	+5VD	+5VD	+5VD
9	$\overline{RD}$	D5	
10		D6	$\overline{CS}$
11		D7	
12	DGND	DGND	DGND
13		D8	
14		D9	
15		D10	
16	DGND	DGND	DGND
17	FL0	D11	$\overline{IRQ2}$
18			
19			
20	DGND	DGND	DGND
21	AGND	AGND	AGND
22	AGND	AGND	AGND
23	AGND	AGND	AGND
24	AGND	AGND	AGND
25	AGND	AGND	AGND
26	AGND	AGND	AGND
27		AGND	
28		AGND	
29	AGND	AGND	AGND
30		AGND	
31	AVSS	AVSS	AVSS
32	AVDD	AVDD	AVDD

Note: The unused pins of the 96-way connector are not shown.

## SOCKETS

There are three input sockets relevant to the operation of the AD7492 on this evaluation board. The function of these sockets is outlined in Table III.

**Table III. Socket Functions**

Socket	Function
SK1	Sub-Miniature BNC Socket for unipolar analog input. Analog inputs in the acceptable AD7492 analog input range (0 V to REFIN) are applied to this socket. The signal is then buffered before it is applied to the AD7492 VIN pin.
SK2	Sub-Miniature BNC Socket for external CONVST input.
SK3	Sub-Miniature BNC Socket for Bipolar analog input. The AD7492 can only accept analog inputs in the range 0 V to REFIN. Bipolar analog inputs in the range -1.25 V to +1.25 V applied to this socket are biased up to the acceptable AD7492 input range by the on-board bias-up circuit before being applied to the AD7492 VIN pin.

## CONNECTORS

There are three connectors on the AD7492 evaluation board as outlined in Table IV.

**Table IV. Connector Functions**

Connector	Function
J1	96-Way Connector for EVAL-CONTROL BRD2 interface connections.
J2	External VDD, VSS & AGND power connector.
J3	External VDRIVE & DGND power connector.

## OPERATING WITH THE EVAL-CONTROL BRD2

The evaluation board can be operated in a stand-alone mode or operated in conjunction with the EVAL-CONTROL BRD2. This EVAL-CONTROL BRD2 is available from Analog Devices under the order entry "EVAL-CONTROL BRD2". When interfacing directly to this control board, all supplies and control signals to operate the AD7492 are provided by the EVAL-CONTROL BRD2 when it is run under control of the AD7492 software which is provided with the AD7492 evaluation board package. This EVAL-CONTROL BRD2 will also operate with all Analog Devices evaluation boards which end with the letters CB in their title.

The 96-way connector on the EVAL-AD7492CB plugs directly into the 96-way connector on the EVAL-CONTROL BRD2. No power supplies are required in the system. The EVAL-CONTROL BRD2 generates all the required supplies for itself and the EVAL-AD7492CB. The EVAL-CONTROL BRD2 is powered from a 12 V AC transformer. Suitable transformers are available as an accessory from Analog Devices under the following part numbers:

EVAL-110VAC-US:	For use in the U.S. or Japan
EVAL-220VAC-UK:	For use in the U.K.
EVAL-220VAC-EU:	For use in Europe

These transformers are also available for other suppliers including Digikey (U.S.) and Campbell Collins (U.K.).

Connection between the EVAL-CONTROL BRD2 and the serial port of a PC is via a standard RS-232 cable which is provided as part of the EVAL-CONTROL BRD2 package. Please refer to the manual which accompanies the EVAL-CONTROL BRD2 for more details on the EVAL-CONTROL BRD2 package.

# EVAL-AD7492CB

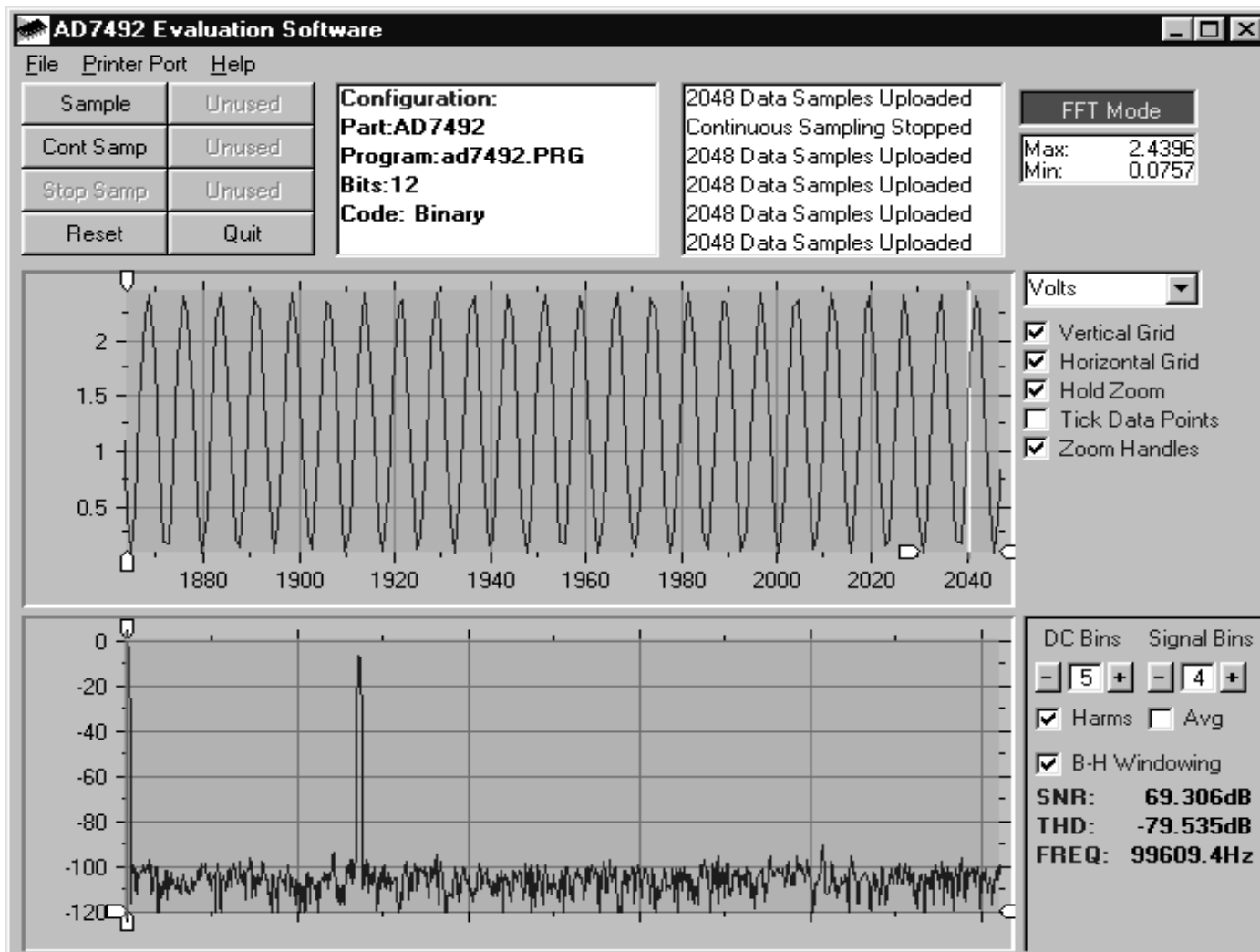

Figure 2. Main Screen

## SOFTWARE DESCRIPTION

The software which controls the Evaluation Board Controller and hence the evaluation board has three main screens.

The screen shown in Figure 2 shows the screen which appears when the software is run. The main function of this screen is to allow the user to read a predetermined number of samples from the evaluation board and display them in both the time and frequency domain. The screen can be divided into 3 sections. The upper third of the screen contains the control buttons, the menu bar and various status windows. The control buttons allow the user to enter the setup menu, take samples and get information about the software. The menu bar allows the user to select which printer port is to be used to control the Evaluation Board Controller, load and save data etc. The status windows indicate the setup of the evaluation board/device, number of samples taken and any information/error messages that are generated.

The middle third of the screen is a Digital Storage Oscilloscope (DSO). When samples are uploaded from the Evaluation Board Controller they are displayed here. The samples can be displayed either as integer values or as voltages (determined by the input range of the device in question). Once samples have been displayed clicking at any point in the graph will

display the sample number and value of the point directly beneath the cursor. Along the axis of the graph are the “zoom handles”. These allow the user to zoom in and out to get a closer look at a particular sample if required. When another set of samples is taken the graph will attempt to display all values collected unless the Hold Zoom check box is ticked. In this case the graph will keep the same axis settings as for the previous set of data samples. Additional check boxes are provided to give the user control over the vertical and horizontal grids and data points. The lower third of the screen will show either a Fast Fourier Transform (FFT) of the data or a Histogram which shows the number of occurrences of each particular code read back. The FFT (the default option) is typically used when the user is concerned with examining an ADC’s performance in the frequency domain while the Histogram will give an indication of the ADC’s performance to DC signals. The option displayed can be toggled by clicking on the FFT Mode/Histogram Mode button in the top right of the screen. Figure 3 shows how the main screen looks when the Histogram Option is selected.

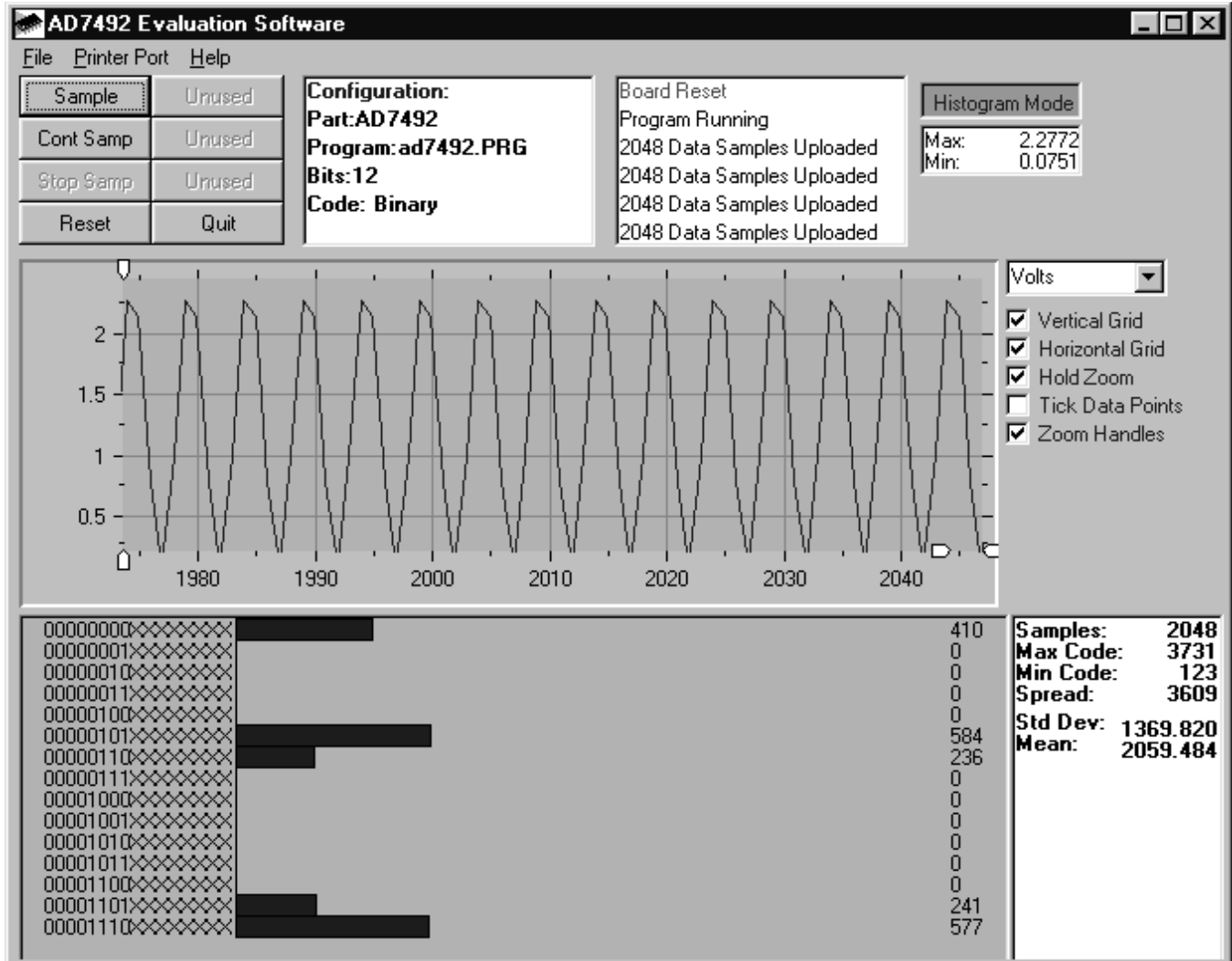

Figure 3. Main Screen - Histogram Mode

### Setup Screen

The Setup Screen is responsible for allowing the user to load a configuration file for the evaluation board. The configuration file will give the software detailed information about the evaluation board and part connected to the Evaluation Board Controller such as number of bits, maximum sampling rate, power supply requirements etc. The configuration file also tells the software the name of the DSP program file which it should download to the Evaluation Board Controller. These files are supplied by Analog Devices with the evaluation board. Figure 4 shows the Setup Screen.

### SETTING UP THE EVALUATION BOARD CONTROLLER

The following text describes how the evaluation board Evaluation Board Controller and software should be set up for the user to begin using the complete system. The Evaluation Board Controller and evaluation board should be connected together (via the 96 way connector). The power should be applied to the Evaluation Board Controller. At this stage the red LED should be flashing which indicates that the Evaluation Board Controller is functional and ready to receive instructions. The software which should have

been installed should be loaded before the printer port cable is connected between the Evaluation Board Controller and the PC. This will ensure that the printer port has been initialized properly. The printer port cable can then be connected between the PC and the Evaluation Board Controller.

### Running the Software

With the hardware setup the user is now in a position to use the software to control the Evaluation Board Controller and evaluation board. In the software the user should select the **File** menu and click on **Setup**. This will display the setup form. A window on the left of the setup form list all the available configuration files. The configuration files are text based files which contain information about the particular evaluation board to be tested. The information will cover such things as the part name, number of samples to be taken, default and maximum sampling frequency power supply settings etc. The configuration file also contains the name of the DSP program file which is to be downloaded to the Evaluation Board Controller. The user should select the relevant configuration file and click **Load**. The Evaluation Board Controller will be reset and the DSP program will be downloaded. When the download has been completed the

# EVAL-AD7492CB

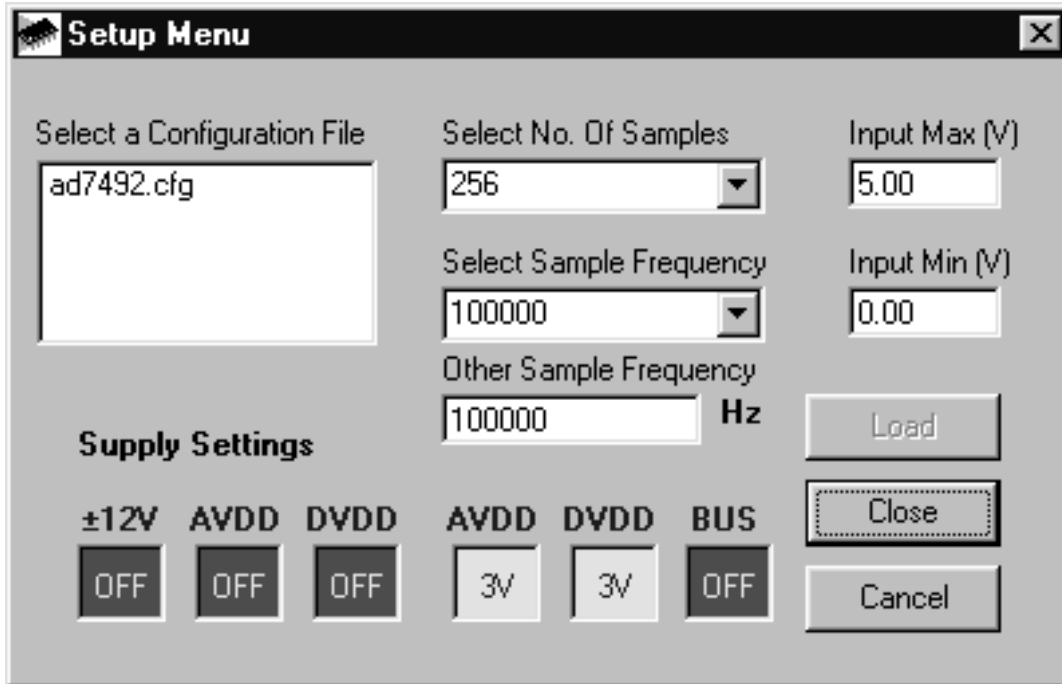

Figure 4. Setup Screen

power supply settings indicated in the configuration file are set and the user may hear some of the relays clicking. The pull-down menus items such as number of samples and sampling frequency will have been set to the default values specified by the configuration file. The user is free to change these at will. Once all the settings had been decided the user can click **Close** to return to the main form.

### Taking Samples

When the user clicks **Sample** the software will instruct the Evaluation Board Controller to take the required number of samples at the required frequency from the evaluation board. These samples are then uploaded and displayed. An FFT and Histogram are also calculated and displayed. If the user clicks **Cont Samp** the software will repeat the process indefinitely until the user clicks the button again. While the software is continuously sampling data the other control buttons are disabled.

### Other Buttons

The **Reset** button will cause the Evaluation Board Controller to perform a reset function. When this happens the power supplies are turned off and the program in DSP memory is lost. The user should repeat the setup instructions to download another program if required.

The **Quit** button will exit the software, the program running on the Evaluation Board Controller is not terminated.

### MENU BAR ITEMS

The main screen of the Evaluation Board Controller contains a number of options available as pull-down menu items. The functions of these are listed below.

#### File Menu:

**Setup Menu:** Selecting this option displays the Setup Screen as shown in Figure 4.

**Load Raw Data:** Selecting this option allows the user to load data which had been saved by the software during a previous session.

**Save Raw Data:** Selecting this option allows the user to save the current set of sample data points. The data can be reloaded to the Evaluation Board Controller software at a later date or can be used by other programs for further analysis

**Save Binary Data:** Selecting this option allows the user to save the current set of sample data points. The data is saved in binary format as a text file. This method can be useful for examining code flicker, looking for stuck bits etc.

**Save FFT Data:** Selecting this option allows the user to save the current set of FFT data points. FFT data cannot be reloaded into the Evaluation Board Controller software but can be loaded into other software packages for further analysis.

**Exit:** Quits the program.

#### Printer Port:

This menu item allows the user to select which printer port should be used for communication with the Evaluation Board Controller.

**LPT1:** This option selects 0x378 as the printer port address. This is the default option.

**LPT2:** This option selects 0x278 as the printer port address.

**PRN:** This option selects 0x3BC as the printer port address.

#### Help:

This menu item gives information about the current revision of software for the particular evaluation board being used.



**SOFTWARE CONFIGURATION FILES**

Software Configuration Files give the Evaluation Board Controller software information on how the software and hardware should perform . They contain information such as the name of the DSP program to download, the default and maximum sample frequencies, the number of samples to take and the power supply settings to use. A typical Software Configuration File (\*.cfg) is shown in Table V.

**Table V.: Typical Software Configuration File.**

```
[EVAL-CONTROL BOARD]
partname:AD7492
programname:ad7492.PRG
```

```
samplefrequency:100000
maxsamplefrequency:750000
samples:2048
```

```
+/-15V:on
dvdd:5:on
avdd:5:on
bus:on
;options 2scomp, binary
dataformat:binary
numberofbits:12
inputVmax:2.5
inputVmin:0
[endofconfig]
```

# EVAL-AD7492CB

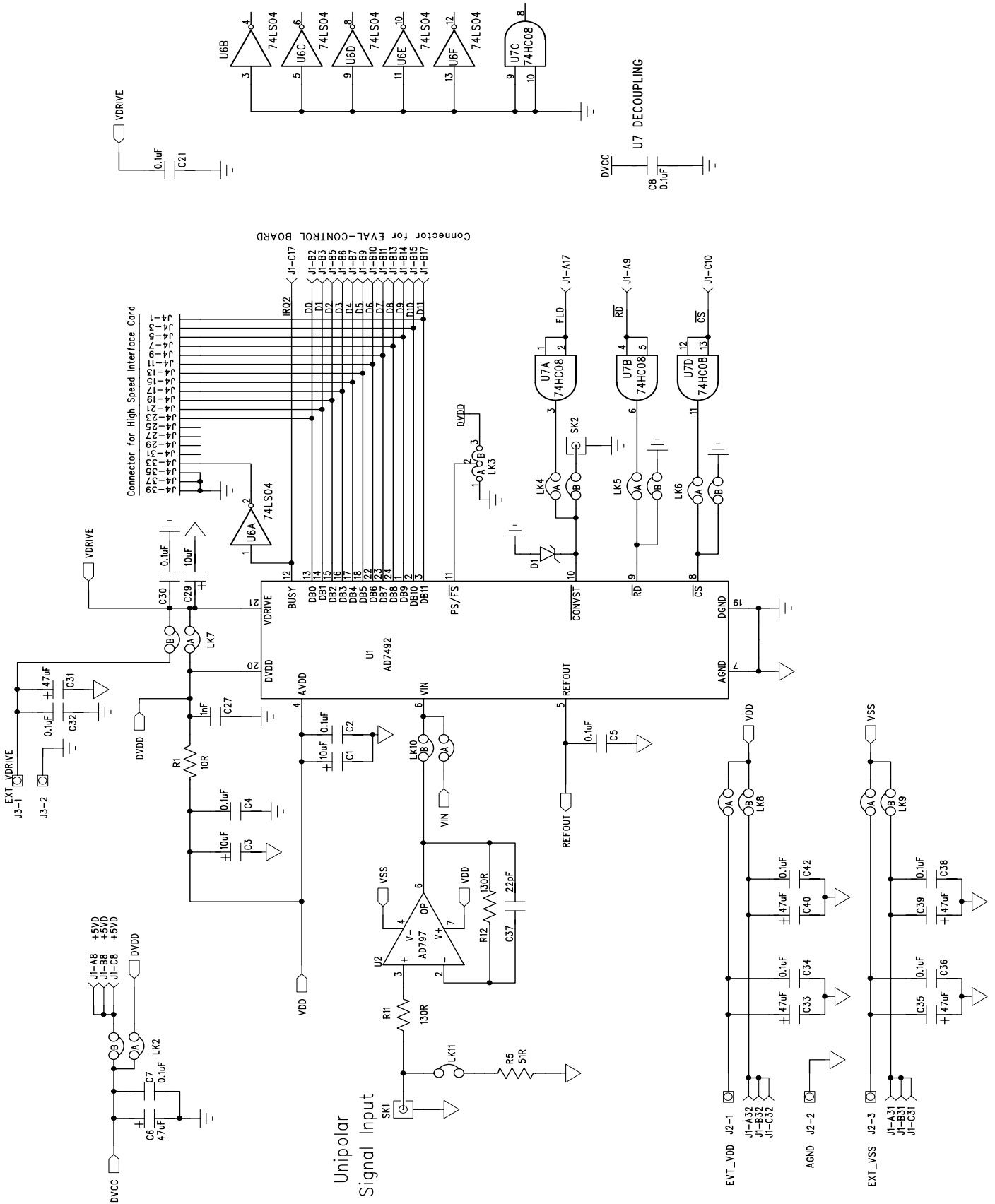

Figure 5. AD7492 Evaluation Board Circuit Diagram



# EVAL-AD7492CB

Table VI. AD7492 Evaluation Board Bill Of Materials

Qty.	PartType	RefDes	Order Number	Supplier/Manuf
1	AD7492BRU	U1	AD7492BRU	ADI
2	AD797BN	U2 U3	AD797BN	ADI
1	OP07DP	U4	OP07DP	ADI
1	AD780AR	U5	AD780AR	ADI
1	MM74HC04M	U6	FEC 379-220	Motorola
1	MM74HC08M	U7	FEC 379-224	Motorola
1	SD103C Schottky Diode	D1	SD103C	
10	10uF, 10V (TAJ-B Series)	C1 C3 C9 C11 C13 C15 C17 C19 C23 C29	FEC 498-660	AVX
2	0.1uF 16V X7R (0603 size)	C2 C4	FEC 499-675	AVX
13	0.1uF 50V X7R (0805 size)	C5 C7 C8 C10 C12 C14 C16 C18 C20-C22 C42 C38	FEC 499-687	AVX
5	0.1uF 50V X7R (0805 size)	C28 C30 C32 C34 C36	FEC 499-687	AVX
1	0.01uF 50V X7R (0805 size)	C24	FEC 499-225	AVX
1	27pF 50V NPO (0603 size)	C25	FEC 722-017	Phillips
1	1nF 50V NPO (0805 size)	C27	FEC 317-457	AVX
6	47uF 16V (TAJ-D Series)	C6 C31 C33 C35 C40 C39	FEC 498-762	AVX
2	22pF 100V NPO (0805 size)	C37 C26	FEC-317-500	AVX
1	4.7uF 16V (TAJ-B Series)	C41	FEC 498-725	AVX
1	10Ω ±1% (0603 Size)	R1	FEC 910-995	Multicomp
2	1KΩ ±1% (0805 Size)	R2 R3	FEC 911-239	Multicomp
2	100Ω ±1% (0805 Size)	R4 R8	FEC 911-732	Multicomp
2	51Ω ±1% (0805 Size)	R5 R7	FEC 771-181	Multicomp
3	20kΩ ±1% (0805 Size)	R6 R9 R10	FEC 771-491	Multicomp
1	130Ω ±1% (0805 Size)	R11	FEC 771-235	Multicomp
1	130Ω ±1% (0805 Size)	R12	FEC 771-235	Multicomp
1	50KΩ Multi-turn trimmer pot	R13	FEC 348-144	Bourns
1	220uH Inductor (8RHB Series)	L1	FEC 598-215	TOKO
1	2 pin header	LK1	FEC 511-705	Harwin
8	4 (2+2) pin header	LK2 LK4 LK5 LK6 LK7 LK8 LK9 LK10	FEC 511-791	Harwin
1	3 pin header (SIP3)	LK3	FEC 671-927	Harwin
10	Shorting Link	LK1 - LK10	FEC 528-456	Berg
24	Ultra Low Profile Sockets	U3 U4 U5	FEC 519-959	Harwin
1	96 Pin 90° DIN41612 Plug	J1	FEC 269-931	Siemens
1	3 Pin Terminal Block	J2	FEC 151-786	Lumberg
1	2 Pin Terminal Block	J3	FEC 151-785	Lumberg
1	40 Pin 90° IDC Ribbon Connector	J4	FEC 727-714	3M
3	Gold 50Ω SMB Jack	SK1 SK2 SK3	FEC 310-682	M/ACOM
4	Stick-on Feet	Each Corner	FEC 148-922	3M
1	PCB	EVAL-AD7492CB	n/a	

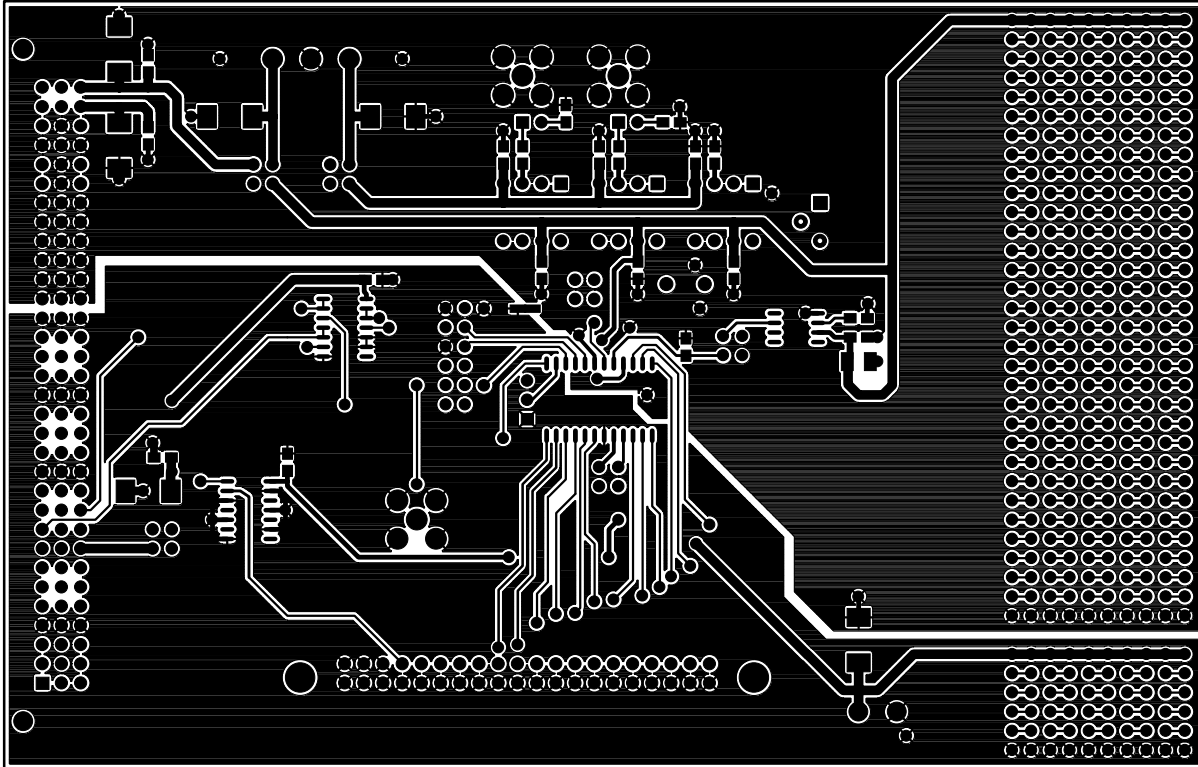

Figure 7. Component Side Artwork

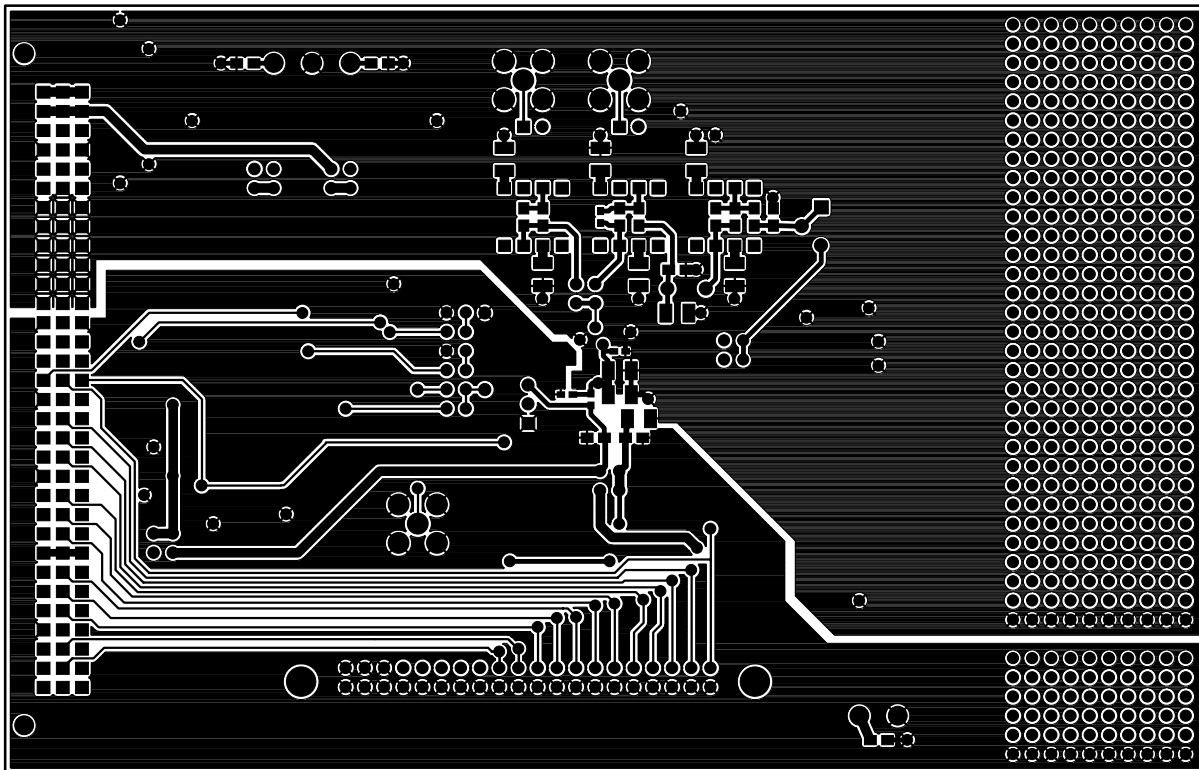

Figure 8. Solder Side Artwork

# EVAL-AD7492CB

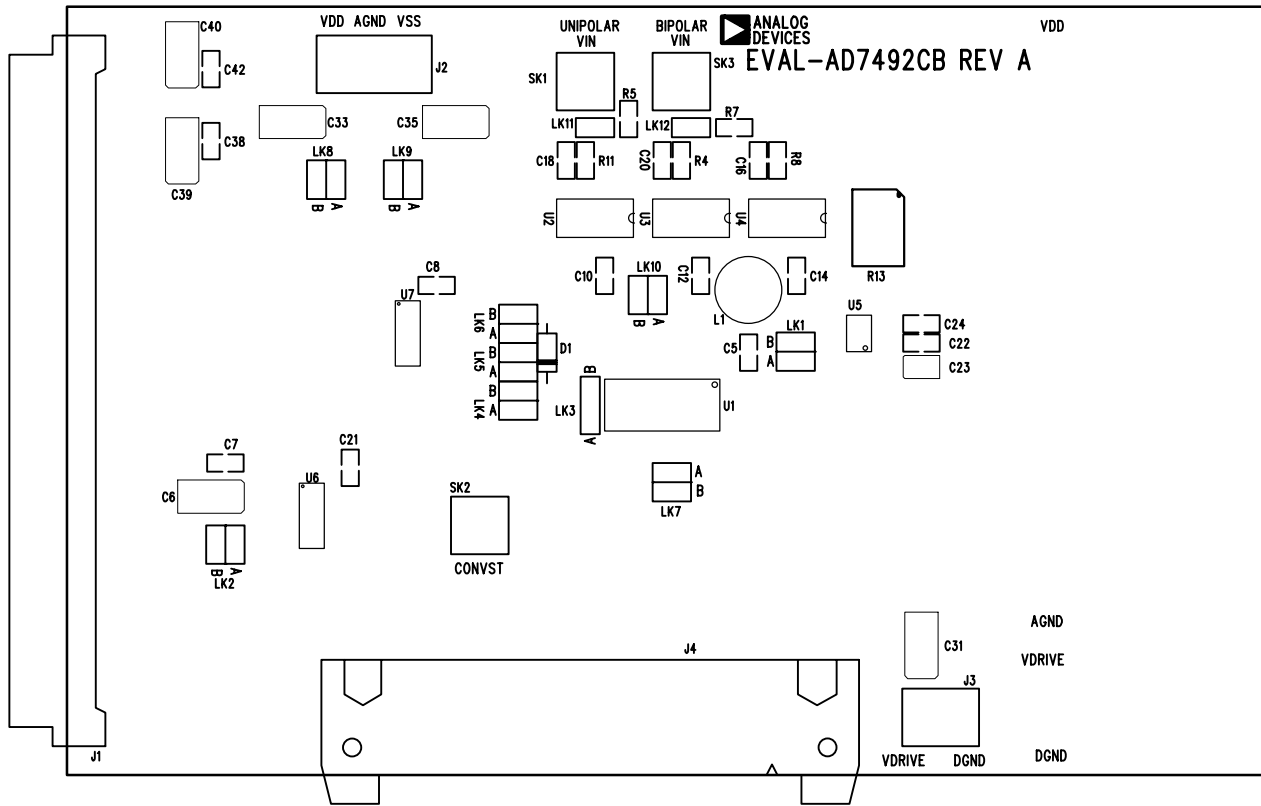

Figure 6. Component Side Artwork