

# FAN8434

## Camcorder 3 in 1 Motor Driver

### Features

Capstan motor drive block

- 3-phase, linear BLDC motor driver with 3 hall sensors.
- Built-in FG amplifier.
- Forward and reverse rotation function.
- Built-in amplitude limiter.

Drum motor drive block

- 3-phase soft commutating sensor less drive method.
- Built-in FG amplifier.
- Built-in PG amplifier.

Loading motor drive block

- Single phase H-bridge driving method.
- 4-mode selection function(forward, reverse, brake,standby).

Common block

- Built-in TSD(thermal shut down)
- Built-in 4-normal op-amp.

### Typical Applications

- Camcorder

### Description

The FAN8434 is a camcorder one-chip motor driver IC. It is composed of capstan motor driver , drum motor driver and loading motor driver.

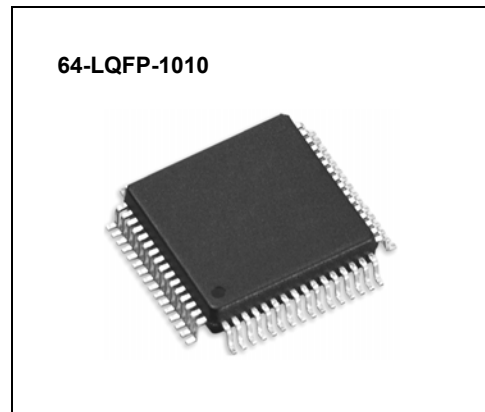

### Ordering Information

Device	Package	Operating Temp.
FAN8434	64-LQFP-1010	-25°C ~ +75°C
FAN8434_NL <sup>note2</sup>	64-LQFP-1010	-25°C ~ +75°C
FAN8434X <sup>note1</sup>	64-LQFP-1010	-25°C ~ +75°C
FAN8434X_NL <sup>note2</sup>	64-LQFP-1010	-25°C ~ +75°C

#### Notes:

1. X: Tape & Reel
2. NL: Lead-free type

## Pin Assignments

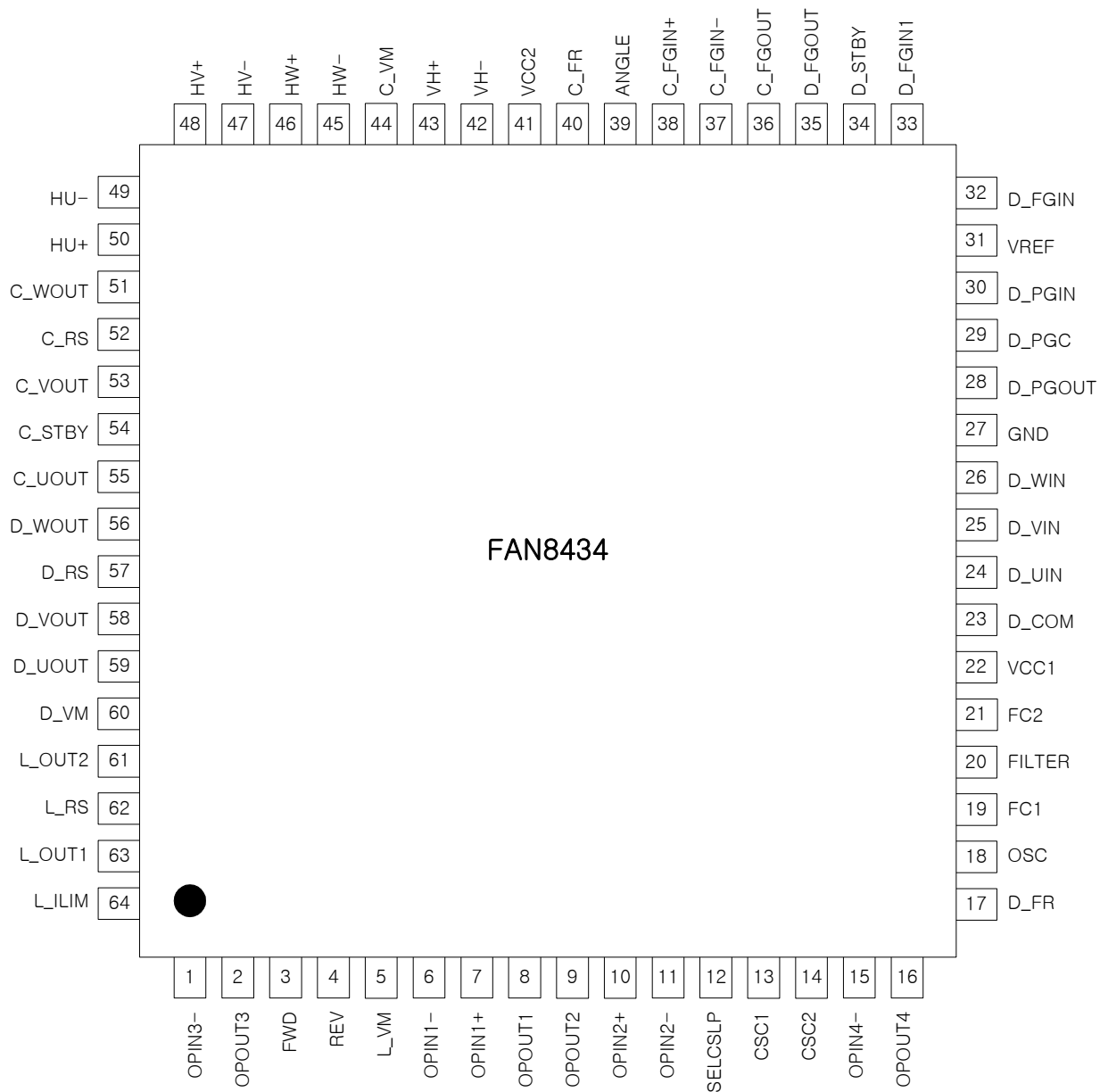

## Pin Definitions

Pin Number	Pin Name	I/O	Pin Function Description
1	OPIN3-	I	OP amp. 3 input -
2	OPOUT3	O	OP amp. 3 output
3	FWD	I	Loading motor forward input
4	REV	I	Loading motor reverse input
5	L_VM	-	Loading motor power supply voltage
6	OPIN1-	I	OP amp. 1 input -
7	OPIN1+	I	OP amp. 1 input +
8	OPOUT1	O	OP amp. 1 output
9	OPOUT2	O	OP amp. 2 output
10	OPIN2+	I	OP amp. 2 input +
11	OPIN2-	I	OP amp. 2 input -
12	SELCSLP	I	Selection pin for oscillator 's slant
13	CSC1	-	Drum motor soft commutating oscillation 1
14	CSC2	-	Drum motor soft commutating oscillation 2
15	OPIN4-	I	OP amp. 4 input -
16	OPOUT4	O	OP amp. 4 output
17	D_FR	I	Drum motor forward / reverse selection pin
18	OSC	-	Drum motor start up oscillation
19	FC1	-	Frequency characteristic
20	FILTER	-	Drum motor torque ripple compensation
21	FC2	-	Output midpoint control
22	VCC1	-	Power supply voltage 1
23	D_MCOM	I	Drum motor Y-connection coil common input
24	D_UIN	I	Drum motor U-phase detect comparator input
25	D_VIN	I	Drum motor V-phase detect comparator input
26	D_WIN	I	Drum motor W-phase detect comparator input
27	GND	-	Signal ground
28	D_PGOUT	O	Drum motor PG comparator output
29	D_PGC	I	Drum motor PG amp. output
30	D_PGIN	I	Drum motor PG input
31	VREF	-	Reference voltage
32	D_FGIN	I	Drum motor FG input

**Pin Definitions** (Continued)

<b>Pine Number</b>	<b>Pin Name</b>	<b>I/O</b>	<b>Pin Function Description</b>
33	D_FGIN1	I	Drum motor FG input 1
34	D_STBY	I	Drum motor standby
35	D_FGOUT	O	Drum motor FG comparator output
36	C_FGOUT	O	Capstan motor FG comparator output
37	C_FGIN-	I	Capstan motor FG input-
38	C_FGIN+	I	Capstan motor FG input+
39	ANGLE	-	Capstan motor output slant selection
40	C_FR	I	Capstan motor forward / reverse selection
41	VCC2	-	Power supply voltage 2
42	VH-	-	Hall bias supply voltage-
43	VH+	-	Hall bias supply voltage+
44	C_VM	-	Capstan motor power supply voltage
45	HW-	I	Capstan motor hall input W-
46	HW+	I	Capstan motor hall input W+
47	HV-	I	Capstan motor hall input V-
48	HV+	I	Capstan motor hall input V+
49	HU-	I	Capstan motor hall input U-
50	HU+	I	Capstan motor hall input U+
51	C_WOUT	O	Capstan motor output W
52	C_RS	-	Capstan motor power ground
53	C_VOUT	O	Capstan motor output V
54	C_STBY	I	Capstan motor standby
55	C_UOUT	O	Capstan motor output U
56	D_WOUT	O	Drum motor output W
57	D_RS	-	Drum motor output current sensing
58	D_VOUT	O	Drum motor output V
59	D_UOUT	O	Drum motor output U
60	D_VM	-	Drum motor power supply voltage
61	L_OUT2	O	Loading motor output 2
62	L_RS	-	Loading motor output current sensing
63	L_OUT1	O	Loading motor output 1
64	L_ILIM	-	Loading motor output current limiting

# Internal Block Diagram

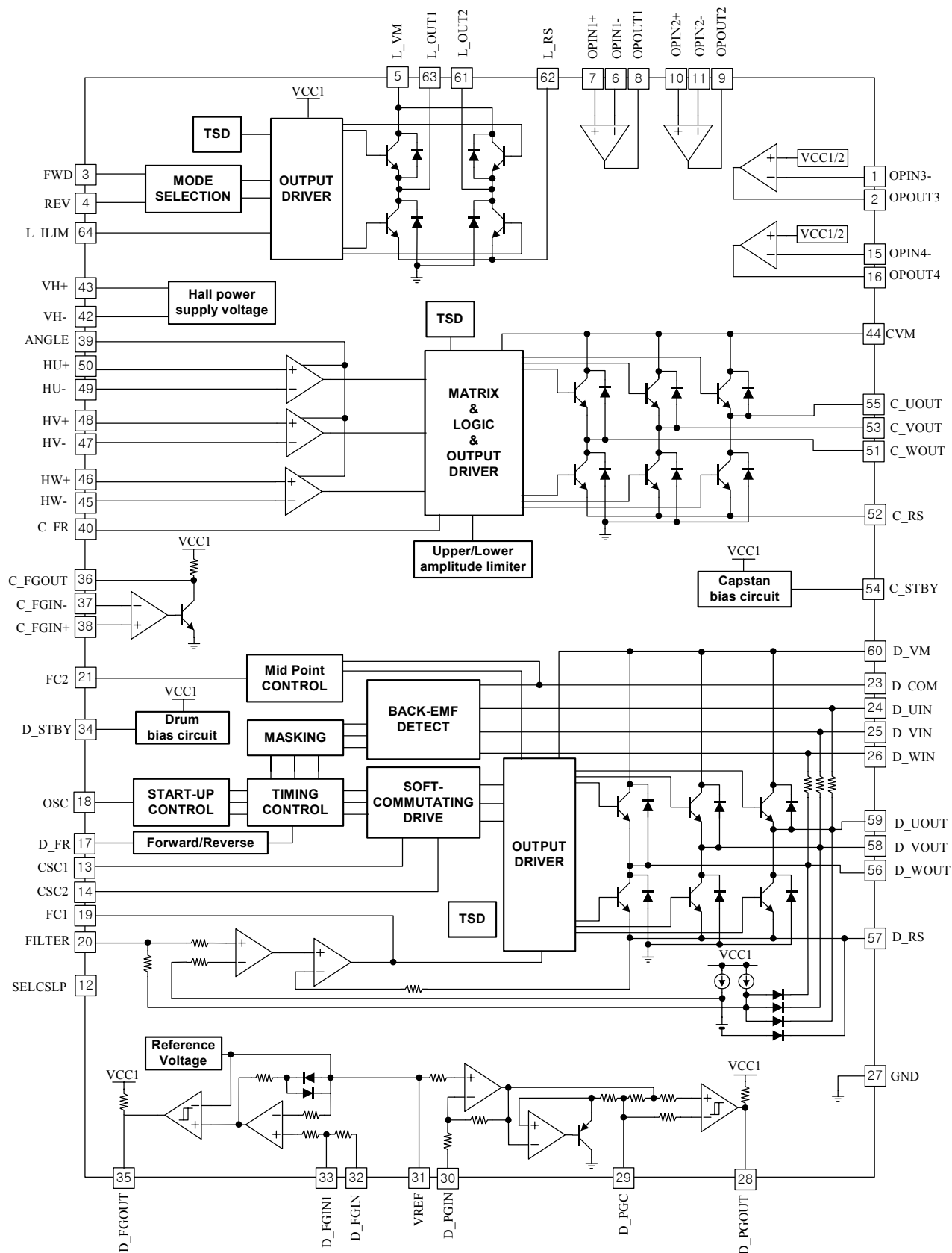

## Equivalent Circuits

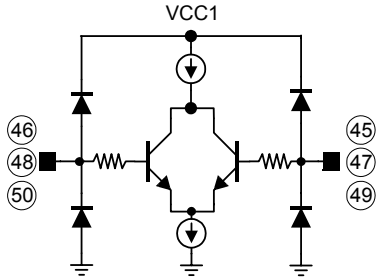
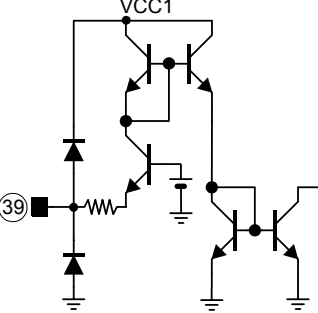
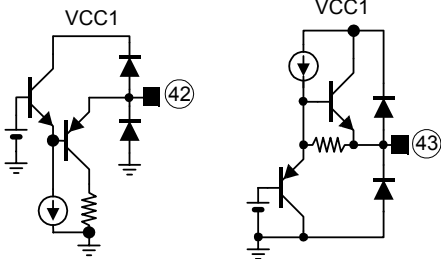
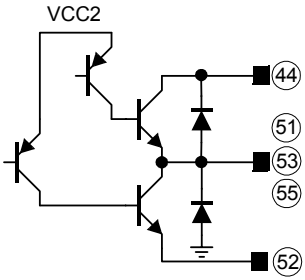
Description	Pin No.	Internal circuit
Hall input	45, 46, 47 48, 49, 50	
Angle	39	
Hall Bias	42,43	
Capstan Output C_UOUT C_VOUT C_WOUT C_RS	51, 53, 55 52	

## Equivalent Circuits (Continued)

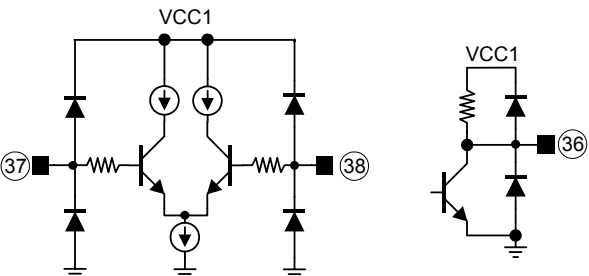
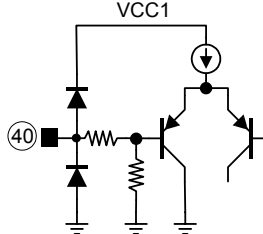
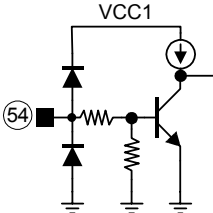
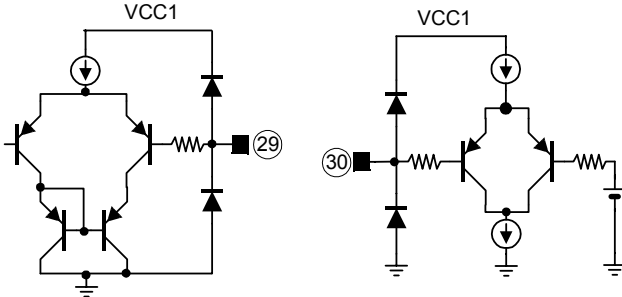
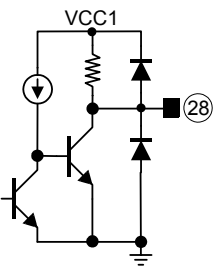
Description	Pin No.	Internal circuit
FG Input & FG Comparator Output	37,38 36	
C_FR	40	
C_STBY	54	
D_PGIN D_PGC	29 30	
D_PGOUT	28	

### Equivalent Circuits (Continued)

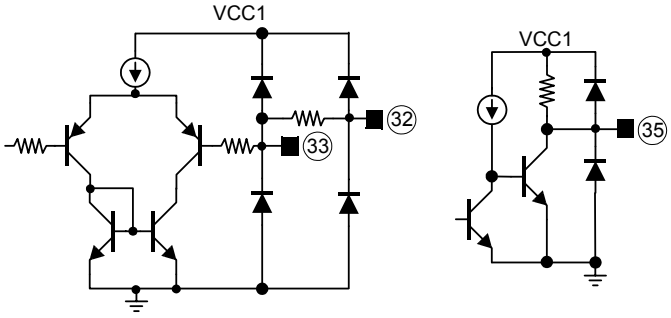
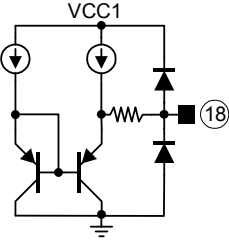
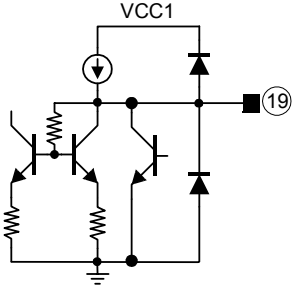
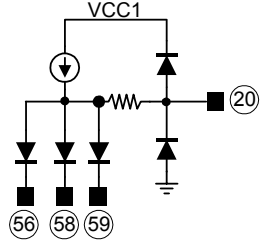
Description	Pin No.	Internal circuit
D_FGIN D_FGIN1 D_FGOUT	32 33 35	
OSC	18	
FC1	19	
Filter	20	

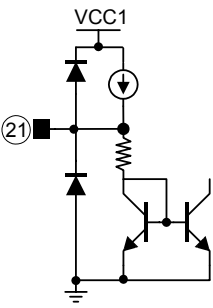
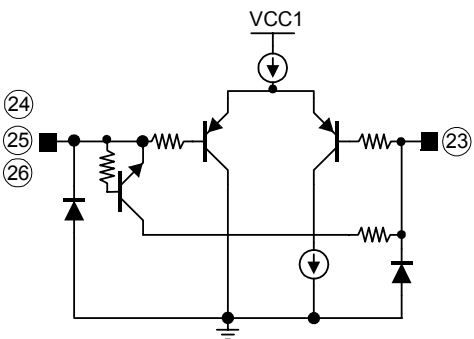
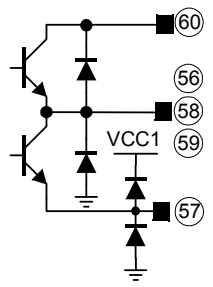
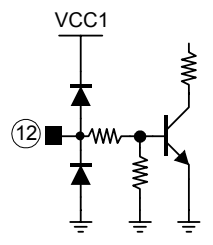

### Equivalent Circuits (Continued)

Description	Pin No.	Internal circuit
FC2	21	
D_UIN D_VIN D_WIN D_COM	24,25,26 23	
Drum Output D_WOUT D_VOUT D_UOUT D_RS	56,58,59, 57	
SELCSLP	12	

### Equivalent Circuits (Continued)

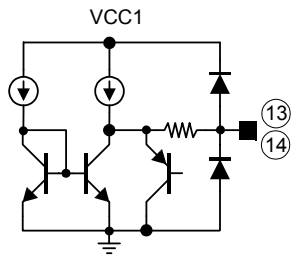
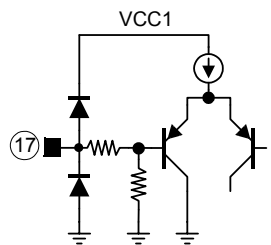
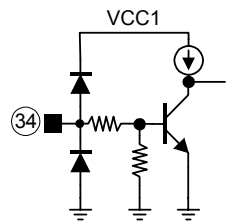
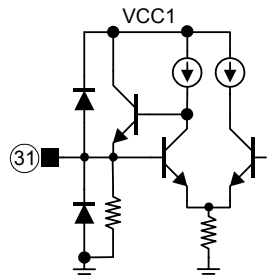
Description	Pin No.	Internal circuit
CSC1 CSC2	13,14	
D_FR	17	
D_STBY	34	
VREF	31	

### Equivalent Circuits (Continued)

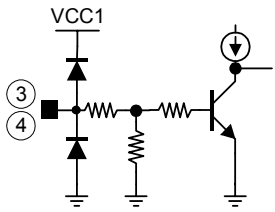
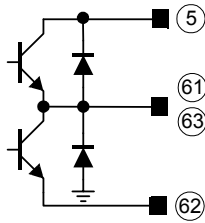
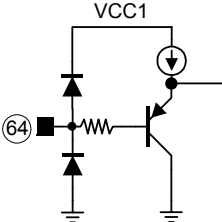
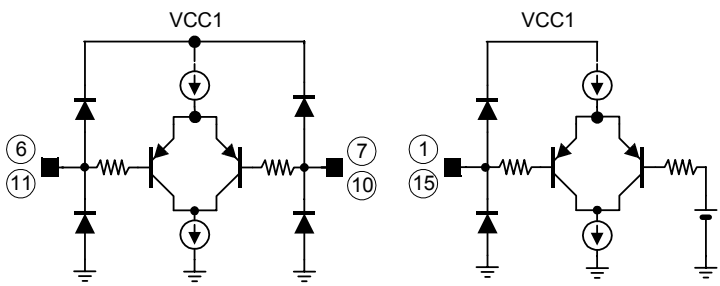
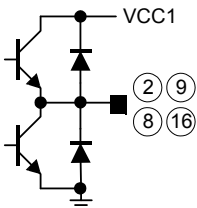
Description	Pin No.	Internal circuit
Loading Input FWD REV	3,4	
Loading Output L_OUT2 L_OUT1 L_RS	61 63 62	
L_ILIM	34	
Normal OP-Amps Input	1,6,7,10,11,15	
Normal OP-Amps Output	2,8,9,16	

## Absolute Maximum Ratings (Ta=25°C)

Parameter	Symbol	Value	Unit	Remark
Maximum IC supply voltage 1	VCC1 <sub>max</sub>	7.0	V	VCC1 ≤ VCC2
Maximum IC supply voltage 2	VCC2 <sub>max</sub>	8.5	V	-
Maximum capstan motor supply voltage	C_VM <sub>max</sub>	7.0	V	C_VM ≤ VCC2
Maximum drum motor supply voltage	D_VM <sub>max</sub>	7.0	V	D_VM ≤ VCC2
Maximum loading motor supply voltage	L_VM <sub>max</sub>	7.0	V	L_VM ≤ VCC2
Maximum capstan motor output current	ICO <sub>max</sub>	1.0	A	VCC2=7V, C_VM=7V
Maximum drum motor output current	IDO <sub>max</sub>	1.0	A	VCC2=7V, D_VM=7V
Maximum loading motor output current	ILO <sub>max</sub>	0.6	A	VCC2=7V, L_VM=7V
Power dissipation	P <sub>d</sub>	0.6 <sup>note1</sup>	W	Individual
Junction temperature	T <sub>J</sub>	150	°C	VCC2=7V, VM=7V
Operating temperature	TOPR	-25 ~ +75	°C	
Storage temperature	TSTG	-55 ~ +150	°C	

### Notes:

- 1) When mounted on glass epoxy PCB (76 × 114 × 1.6mm)
- 2) Power dissipation is reduced at the rate of -4.8mW/°C for TA≥25°C.
- 3) Do not exceed P<sub>d</sub> and SOA(Safe Operating Area).

## Power Dissipation Curve

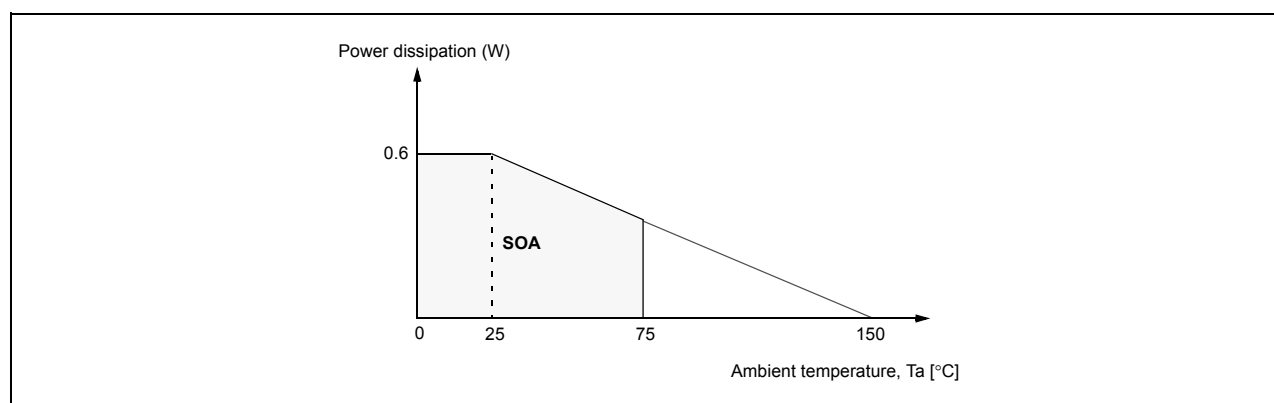

## Recommended Operating Conditions (Ta=25°C)

Parameter	Symbol	Value	Units
IC supply voltage1	VCC1 <sup>note2</sup>	2.7 ~ 6	V
IC supply voltage2	VCC2	3.5 ~ 8.5	V
Capstan motor supply voltage	C_VM <sup>note3</sup>	0 ~ 7.0	V
Drum motor supply voltage	D_VM <sup>note3</sup>	0 ~ 7.0	V
Loading motor supply voltage	L_VM <sup>note3</sup>	0 ~ 7.0	V

### Notes:

2. Conditions: VCC1 ≤ VCC2
3. Conditions: C\_VM ≤ VCC2, D\_VM ≤ VCC2, L\_VM ≤ VCC2

## Electrical Characteristics

(VCC1=3V, VCC2=4.75V, C\_VM=1.5V, D\_VM=L\_VM=3V, DRS=0.25Ω, Ta=25°C, unless otherwise specified)

Parameter	Symbol	Conditions	Min.	Typ.	max.	Unit
VCC1 power supply current1	ICC1	IOUT=100mA, VC_STBY=3V	-	4	8	mA
VCC2 power supply current2	ICC2	IOUT=100mA, VC_STBY=3V	-	6	12	mA
VCC1 Idle current	ICC1Q	VC_STBY=0V	-	2.1	4	mA
VCC2 Idle current	ICC2Q	VC_STBY=0V	-	-	100	μA
VM Idle current	IVMQ	VC_STBY=0V	-	75	100	μA
<b>CAPSTAN MOTOR BLOCK</b>						
Upper side saturation voltage1	VCSATH1	Io=0.2A, VC_STBY=3V	-	0.22	0.29	V
Lower side saturation voltage1	VCSATL1	Io=0.2A, VC_STBY=3V	-	0.20	0.25	V
Upper side saturation voltage2	VCSATH2	Io=0.5A, VC_STBY=3V	-	0.25	0.4	V
Lower side saturation voltage2	VCSATL2	Io=0.5A, VC_STBY=3V	-	0.25	0.4	V
Output saturation voltage	VCOSAT	Io=0.8A, Sink+Source	-	-	1.4	V
Overlap amount <sup>note</sup>	O.L	RL=39Ω*3, Range=20KΩ	73	80	87	%
<b>HALL AMPLIFIER</b>						
Input offset voltage <sup>note</sup>	VHOFF	C_RS=0.5Ω, C_CTL=5V	-5	-	5	mV
Common mode input range	VHCM	Range=20KΩ	0.95	-	2.1	V
Voltage gain	VHGM	Range=20KΩ	23	26	29	dB
<b>STANDBY PIN</b>						
High level voltage	VCSTH	-	2.5	-	VCC1	V
Low level voltage	VCSTL	-	-0.2	-	0.7	V
Input current	ICSTIN	VC_STBY=3V	-	-	50	μA
Leakage current	ICSTLK	VC_STBY=0V	-30	-	-	μA
<b>FR PIN</b>						
High level voltage	VCFRH	-	2.5	-	VCC1	V
Low level voltage	VCFRL	-	-0.2	-	0.7	V
Input current	ICFRIN	VC_STBY=3V	-	20	30	μA
Leakage current	ICFRLK	VC_STBY=0V	-30	-	-	μA
<b>HALL BIAS</b>						
Hall power supply voltage	VHALL	IH=5mA, VH(+)-VH(-)	0.55	0.65	0.75	V
(-)pin voltage	VH-	IH=5mA	0.86	0.93	1.00	V
<b>FG COMPARATOR</b>						
Input offset voltage	VFGOFF	-	-3	-	3	mV
Input bias current	IFG	VFGIN+=VFGIN-=1.5V	-	-	500	nA
Input bias current offset	ΔIFG	VFGIN+=VFGIN-=1.5V	-100	-	100	nA
Common mode input range	VFGCM	-	1.2	-	2.5	V
High level output voltage	VFGOH	Internal pull-up	2.8	-	-	V
Low level output voltage	VFGOL	Internal pull-up	-	-	0.2	V
Voltage gain <sup>note</sup>	VFGGM	-	-	100	-	dB
Output current(sink)	IFGOS	Outpin="L"	-	-	100	μA

(\*note) Guaranteed field ( No EDS / Final test )

**Electrical Characteristics**(Continued)

(VCC1=3V, VCC2=4.75V, C\_VM=1.5V, D\_VM=L\_VM=3V, DRS=0.25Ω, Ta=25°C, unless otherwise specified)

Parameter	Symbol	Conditions	Min.	Typ.	max.	Unit
<b>DRUM MOTOR BLOCK</b>						
Power supply current <sup>3</sup>	ICC3	I <sub>o</sub> =76mA, VD_STBY=3V, VC_STBY=0V	-	0.75	2.5	mA
Output Idle current <sup>4</sup>	ICC4Q	VD_STBY=0V, VC_STBY=0V	-	-	100	μA
Output Idle current <sup>5</sup>	ICC5Q	VD_STBY=0V, VC_STBY=0V	-	100	300	μA
Upper side saturation voltage <sup>1</sup>	VSATH3	I <sub>o</sub> =0.1A, RS=0.25Ω	-	0.3	0.5	V
Lower side saturation voltage <sup>1</sup>	VSATL3	I <sub>o</sub> =0.1A, RS=0.25Ω	-	0.3	0.5	V
Upper side saturation voltage <sup>2</sup>	VSATH4	I <sub>o</sub> =0.4A, D_VM=3V, RS=0.25Ω	-	0.5	0.8	V
Lower side saturation voltage <sup>2</sup>	VSATL4	I <sub>o</sub> =0.4A, D_VM=3V, RS=0.25Ω	-	0.5	0.8	V
COM pin common mode input range	VIC	-	0.3	-	VCC2-0.9	V
<b>STANDBY PIN</b>						
High level voltage	VDSTH	-	2.0	-	VCC1	V
Low level voltage	VDSTL	-	-0.2	-	0.7	V
Input current	IDSTIN	VD_STBY=3V	-	-	50	μA
Leakage current	IDSTLK	VD_STBY=0V	-10	-	-	μA
<b>FR PIN</b>						
High level voltage	VDFRH	-	2.0	-	VCC1	V
Low level voltage	VDFRL	-	-0.2	-	0.7	V
Input current	IDFRIN	VC_STBY=3V	-	-	50	μA
Leakage current	IDFRLK	VC_STBY=0V	-10	-	-	μA
<b>OSCILLATOR</b>						
Source current ratio <sup>note</sup>	RSOUR	ICSC1SOUR/ICSC2SOUR	-15	-	+15	%
Sink current ratio <sup>note</sup>	RSINK	ICSC1SINK/ICSC2SINK	-15	-	+15	%
CSC1 source/sink current ratio <sup>note</sup>	RCSC1	ICSC1SOUR/ICSC1SINK	-35	-	+15	%
CSC2 source/sink current ratio <sup>note</sup>	RCSC2	ICSC2SOUR/ICSC2SINK	-35	-	+15	%
Startup frequency <sup>note</sup>	Freq	COSC=0.1μF, OSC freq.=target	-	12.5	-	Hz
Phase delay-width <sup>note</sup>	Dw	Target	-	30	-	deg
<b>SELCSLP PIN</b>						
High level voltage	VSELH	-	2.0	-	VCC1	V
Low level voltage	VSELL	-	-0.2	-	0.7	V
Input current	ISELH	VSELCSLP=3V	-	-	50	μA
Leakage current	ISELLK	VSELCSLP=0V	-10	-	-	μA

(\*note) Guaranteed field ( No EDS / Final test )

**Electrical Characteristics**(Continued)

(VCC1=3V, VCC2=4.75V, C\_VM=1.5V, D\_VM=L\_VM=3V, DRS=0.25Ω, Ta=25°C, unless otherwise specified)

Parameter	Symbol	Conditions	Min.	Typ.	max.	Unit
<b>DRUM MOTOR BLOCK</b>						
<b>FG AMP. &amp; COMPARATOR</b>						
Input offset voltage <sup>note</sup>	VDFGOF	-	-	±1	±5	mV
Input bias current <sup>note</sup>	IDFG	-	-	-	250	nA
Common mode input voltage range <sup>note</sup>	VICOM	-	1.0	-	2.0	V
Open loop gain <sup>note</sup>	DFGGM	f=1KHz	-	55	-	dB
Output on voltage	VFGOL	Io=10μA	-	-	0.4	V
Output off voltage	VFGOH	Io=10μA	VCC1-0.5	-	-	V
Schmitt amplifier hysteresis width <sup>note</sup>	VFGHYS	-	-	50	-	mV
Reference voltage	VREF	-	1.15	1.30	1.45	V
<b>PG AMP. &amp; COMPARATOR</b>						
Input offset voltage <sup>note</sup>	VDPGOF	-	-	±1	±5	mV
Input bias current <sup>note</sup>	IDPG	-	-	-	250	nA
Common mode input voltage range <sup>note</sup>	VICOM	-	1.0	-	2.0	V
Open loop gain <sup>note</sup>	DPGGM	f=1KHz	-	55	-	dB
Output on voltage	VPGOL	Io=10μA	-	-	0.4	V
Output off voltage	VPGOH	Io=10μA	VCC1-0.5	-	-	V
Schmitt amplifier hysteresis width <sup>note</sup>	VPGHYS	-	-	50	-	mV

(\*note) Guaranteed field ( No EDS / Final test )

**Electrical Characteristics**(Continued)

(VCC1=3V, VCC2=4.75V, C\_VM=1.5V, D\_VM=L\_VM=3V, DRS=0.25Ω, Ta=25°C, unless otherwise specified)

Parameter	Symbol	Conditions	Min.	Typ.	max.	Unit
<b>LOADING MOTOR BLOCK</b>						
VCC1 power supply current1	ICC6	VC_STBY=VD_STBY=0V, FWD=REV="L"	-	2.1	4.0	mA
VCC1 power supply current2	ICC7	VC_STBY=VD_STBY=0V, FWD="H",REV="L" or FWD="L",REV="H"	-	14	19	mA
VCC1 power supply current3	ICC8	VC_STBY=VD_STBY=0V, FWD=REV="H"	-	30	40	mA
VCC2 power supply current1	ICC9	VC_STBY=VD_STBY=0V, FWD=REV="L",VCC1=open	-	-	100	μA
VCC2 power supply current2	ICC10	VC_STBY=VD_STBY=0V, FWD=REV="L",VCC1=3.0V	-	-	100	μA
VCC2 power supply current3	ICC11	VC_STBY=VD_STBY=0V, FWD="H",REV="L" or FWD="L",REV="H"	-	15	25	mA
L_VM power supply current	IL_VM	VC_STBY=VD_STBY=0V, FWD=REV="L"	-	-	20	μA
<b>FWD/REV PIN</b>						
High level input voltage	VINH	VCC1=2.7 to 4.0V	2.0	-	VCC1	V
High level input current	IINH	VIN=3.0V	-	41	65	μA
Low level input voltage	VINL	VCC1=2.7 to 4.0V	-0.2	-	0.6	V
Low level input current	IINL	VIN=0.6V	-	5	10	μA
<b>OUTPUT</b>						
Output saturation voltage1	VLSAT1	Io=200mA,Upper+Lower	-	0.2	0.3	V
Output saturation voltage2	VLSAT2	Io=400mA,Upper+Lower	-	0.4	0.6	V
<b>NORMAL OPAMP</b>						
Input offset voltage	VIOFF	-	-	±1	±5	mV
Input bias current	IB	-	-	-	1	μA
Common mode input voltage range	VICM	-	1.0	-	2.0	V
Open loop gain	GM1	-	-	55	-	dB
<b>THERMAL SHUTDOWN</b>						
TSD operating temperature <sup>note</sup>	TSD	-	-	160	-	°C
TSD Hysteresis <sup>note</sup>	HTSD	-	-	15	-	°C

(\*note) Guaranteed field ( No EDS / Final test )



## Application Information

### 1. Capstan Motor Driver Truth Table

	Source → Sink	Hall input			C_FR
		U	V	W	
1	V → W	H	H	L	H
	W → V				L
2	U → W	H	L	L	H
	W → U				L
3	U → V	H	L	H	H
	V → U				L
4	W → V	L	L	H	H
	V → W				L
5	W → U	L	H	H	H
	U → W				L
6	V → U	L	H	L	H
	U → V				L

**Notes:**

- C\_FR "H" is above 2.5V, C\_FR "L" is below 0.4V.
- Hall input "H" is that input(+) is higher than input(-) 0.02V over.  
Hall input "L" is that input(+) is lower than input(-) 0.02V over

### 2. Loading Motor Truth Table

Input		Output		Mode
FWD	REV	LOUT1	LOUT2	
L	L	OFF	OFF	Standby
H	L	H	L	Forward
L	H	L	H	Reverse
H	H	H	H	Brake

# Test Circuits

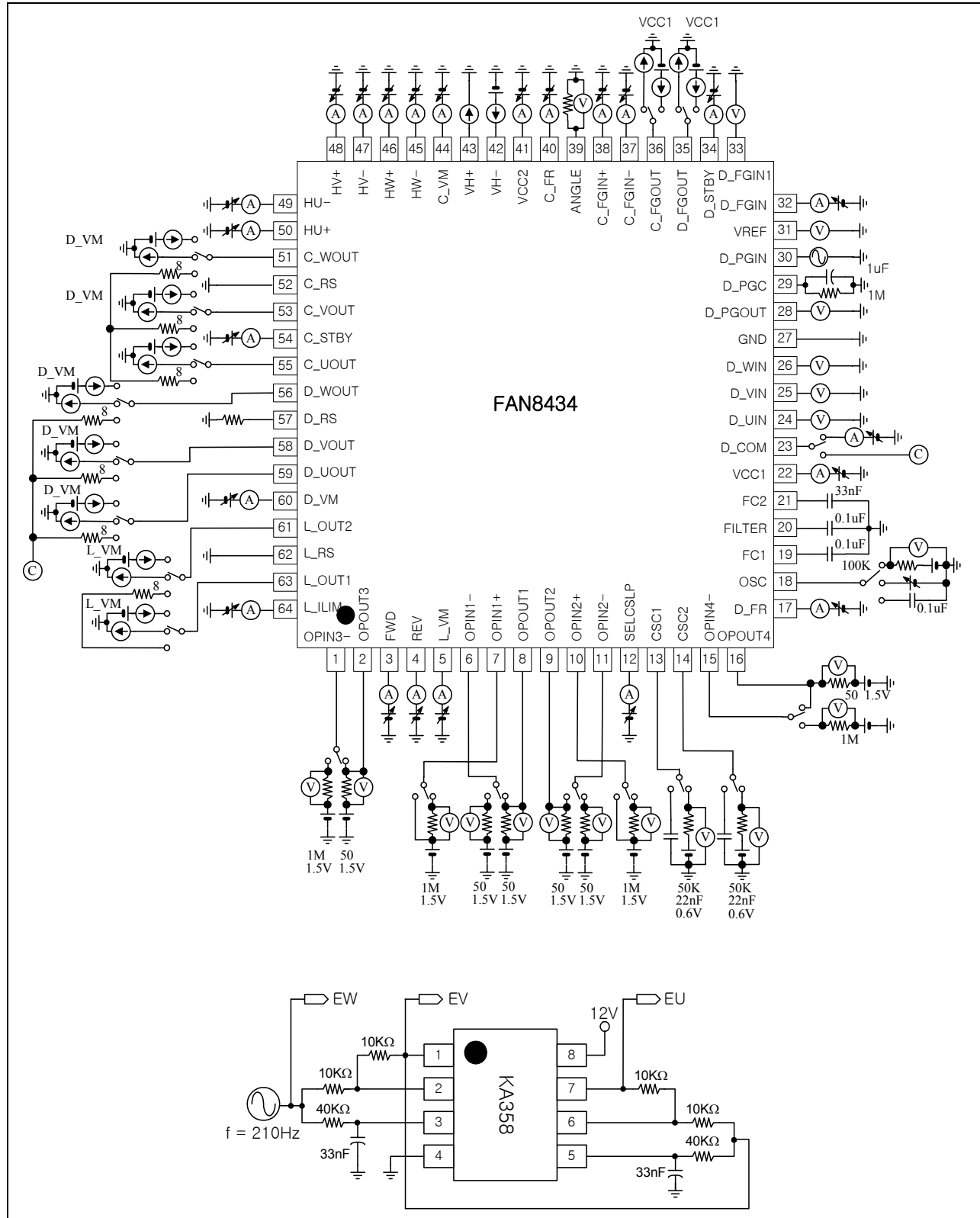

# Typical Application Circuits

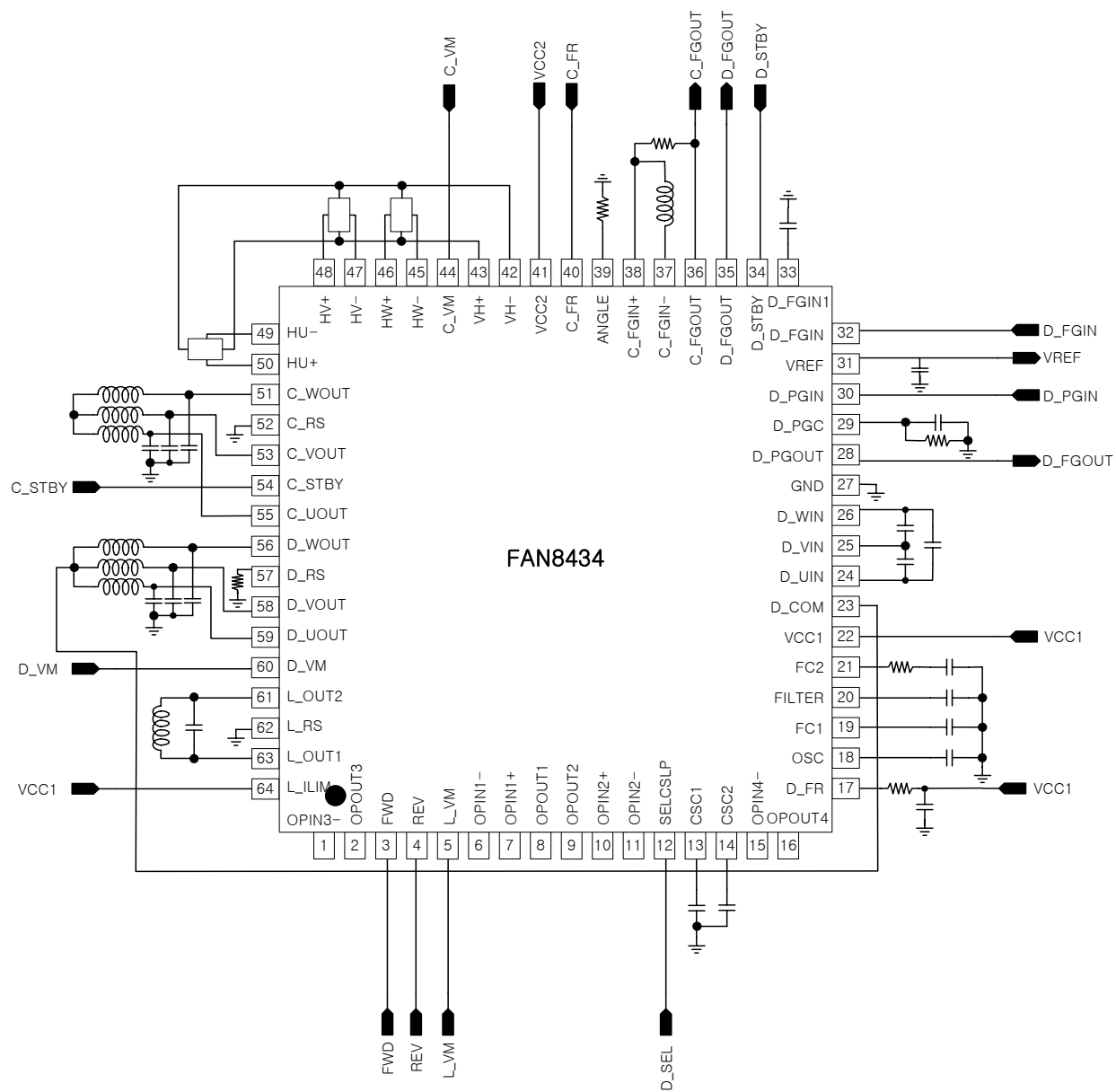

# Package Dimension

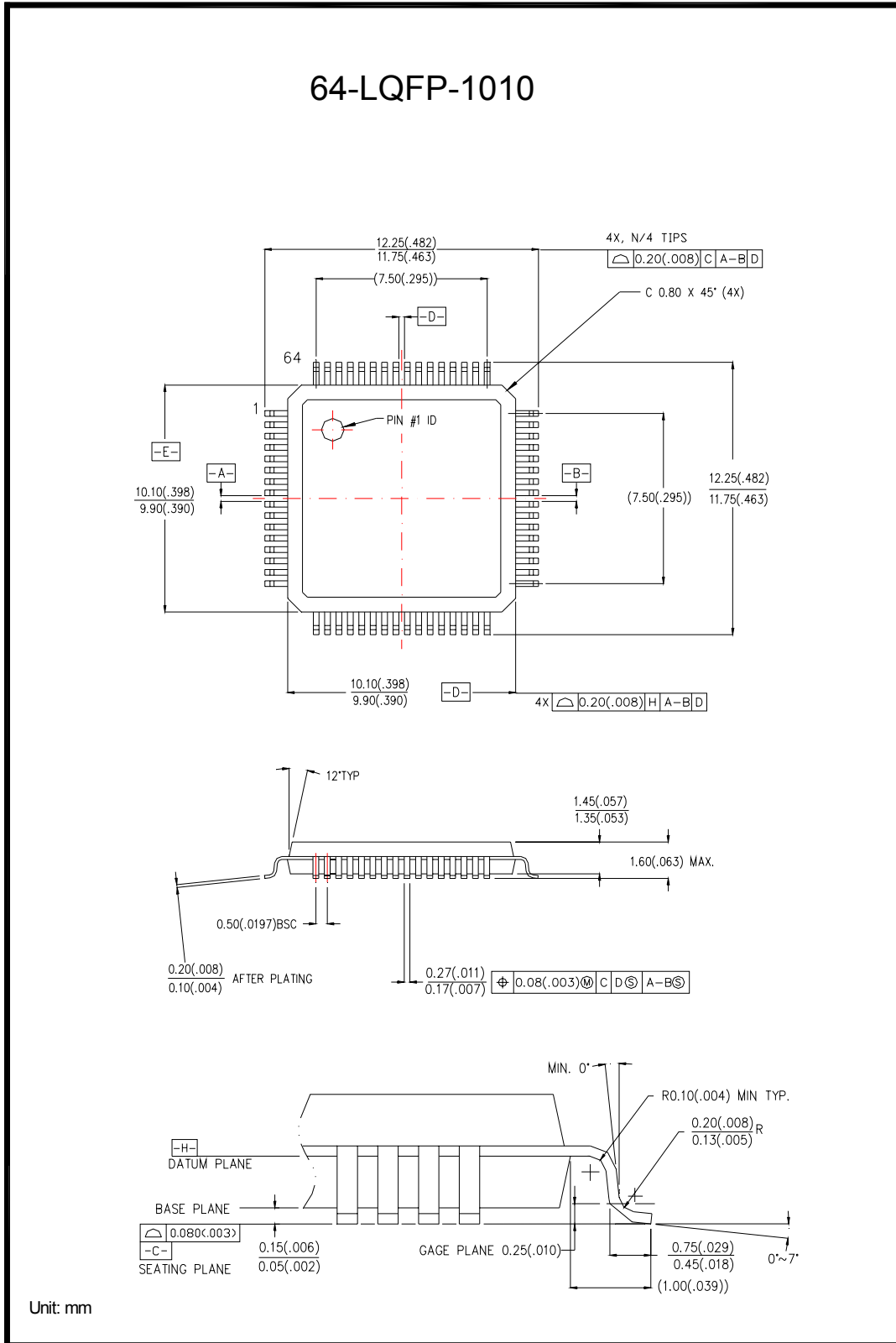



**DISCLAIMER**

FAIRCHILD SEMICONDUCTOR RESERVES THE RIGHT TO MAKE CHANGES WITHOUT FURTHER NOTICE TO ANY PRODUCTS HEREIN TO IMPROVE RELIABILITY, FUNCTION OR DESIGN. FAIRCHILD DOES NOT ASSUME ANY LIABILITY ARISING OUT OF THE APPLICATION OR USE OF ANY PRODUCT OR CIRCUIT DESCRIBED HEREIN; NEITHER DOES IT CONVEY ANY LICENSE UNDER ITS PATENT RIGHTS, NOR THE RIGHTS OF OTHERS.

**LIFE SUPPORT POLICY**

FAIRCHILD'S PRODUCTS ARE NOT AUTHORIZED FOR USE AS CRITICAL COMPONENTS IN LIFE SUPPORT DEVICES OR SYSTEMS WITHOUT THE EXPRESS WRITTEN APPROVAL OF THE PRESIDENT OF FAIRCHILD SEMICONDUCTOR CORPORATION. As used herein:

1. Life support devices or systems are devices or systems which, (a) are intended for surgical implant into the body, or (b) support or sustain life, and (c) whose failure to perform when properly used in accordance with instructions for use provided in the labeling, can be reasonably expected to result in a significant injury of the user.
2. A critical component in any component of a life support device or system whose failure to perform can be reasonably expected to cause the failure of the life support device or system, or to affect its safety or effectiveness.