

FDC6330L

Integrated Load Switch

General Description

This device is particularly suited for compact power management in portable electronic equipment where 3V to 20V input and 2.3A output current capability are needed. This load switch integrates a small N-Channel power MOSFET (Q1) which drives a large P-Channel power MOSFET (Q2) in one tiny SuperSOT™-6 package.

Applications

- Power management
- Load actuation

Features

- $V_{DROP} = 0.2V @ V_{IN} = 12V, I_L = 2.5 A. R_{(ON)} = 0.08 \Omega$
 $V_{DROP} = 0.2V @ V_{IN} = 5V, I_L = 1.6 A. R_{(ON)} = 0.125 \Omega.$
- Control MOSFET (Q1) includes Zener protection for ESD ruggedness (>6kV Human Body Model).
- High performance PowerTrench™ technology for extremely low on-resistance.
- SuperSOT™-6 package design using copper lead frame for superior thermal and electrical capabilities.



SuperSOT™-6

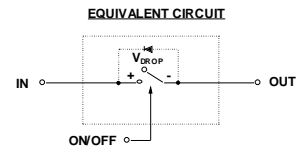
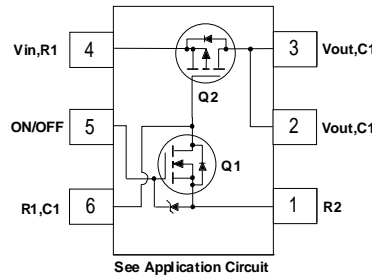

Absolute Maximum Ratings T_A=25°C unless otherwise noted

Symbol	Parameter	Ratings	Units
V _{IN}	Input Voltage Range (Note 1)	3 - 20	V
V _{ON/OFF}	On/Off Voltage Range	1.5 - 8	V
I _D	Load Current - Continuous (Note 2)	2.3	A
		10	
P _D	Maximum Power Dissipation (Note 1)	0.7	W
T _J , T _{stg}	Operating and Storage Temperature Range	-55 to +150	°C
ESD	Electrostatic Discharge Rating MIL-STD-883D Human-Body-Model (100pf/1500 Ohm)	6	kV

Thermal Characteristics

R _{θJA}	Thermal Resistance, Junction-to-Ambient (Note 2)	180	°C/W
R _{θJC}	Thermal Resistance, Junction-to-Case (Note 2)	60	°C/W

Package Marking and Ordering Information

Device Marking	Device	Reel Size	Tape width	Quantity
.330 (. Denotes pin 1)	FDC6330L	7"	8mm	3000 units

Electrical Characteristics T_A=25°C unless otherwise noted

Symbol	Parameter	Test Conditions	Min	Typ	Max	Units
OFF Characteristics						
I _{FL}	Leakage Current	V _{IN} = 20 V, V _{ON/OFF} = 250 μA			1	μA
ON Characteristics (Note 3)						
V _{DROP}	Conduction Voltage	V _{IN} = 12 V, V _{ON/OFF} = 3.3 V, I _L = 2.5 A			0.2	V
		V _{IN} = 5 V, V _{ON/OFF} = 3.3 V, I _L = 1.6 A			0.2	V
R _(ON)	Q ₂ - Static On-Resistance	V _{GS} = -12 V, I _D = -2.3 A V _{GS} = -5 V, I _D = -1.9 A		0.054 0.081	0.08 0.125	Ω
I _L	Load Current	V _{DROP} = 0.2 V, V _{IN} = 12 V, V _{ON/OFF} = 3.3 V	2.5			A
		V _{DROP} = 0.2 V, V _{IN} = 5 V, V _{ON/OFF} = 3.3 V	1.6			

Notes:

1. Range of V_{in} can be up to 30V, but R₁ and R₂ must be scaled such that V_{GS} of Q2 does not exceed 20V.
2. R_{θJA} is the sum of the junction-to-case and case-to-ambient thermal resistance where the case thermal reference is defined as the solder mounting surface of the drain pins. R_{θJC} is guaranteed by design while R_{θJA} is determined by the user's board design.
3. Pulse Test: Pulse Width ≤ 300μs, Duty Cycle ≤ 2.0%.

FDC6330L Load Switch Application

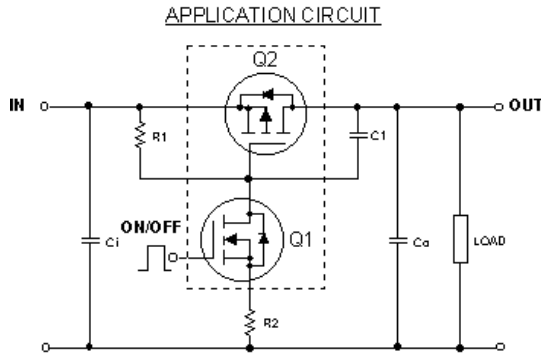

External Component Recommendation:

- For applications where Co ≤ 1μF.
- For slew rate control, select R2 in the range of 1k - 4.7kΩ .
- For additional in-rush current control, C1 ≤ 1000pF can be added.
- Select R1 so that the R1/R2 ratio ranges from 10 - 100. R1 is required to turn Q2 off.

Typical Characteristics (continued)

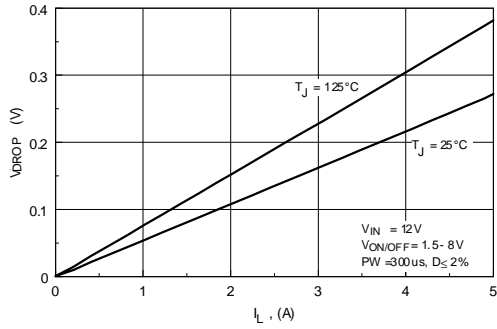

Figure 1. Conduction Voltage Drop Variation with Load Current.

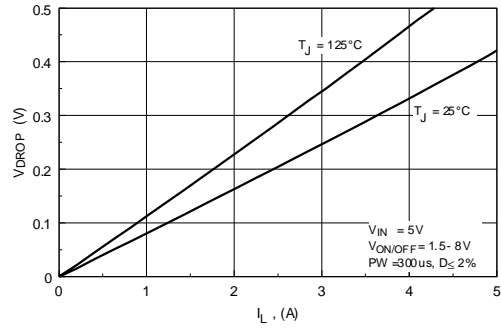

Figure 2. Conduction Voltage Drop Variation with Load Current.

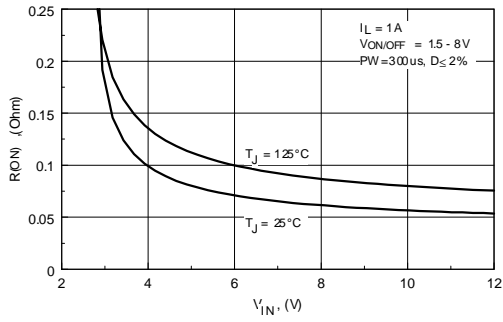

Figure 3. On-Resistance Variation with Input Voltage.

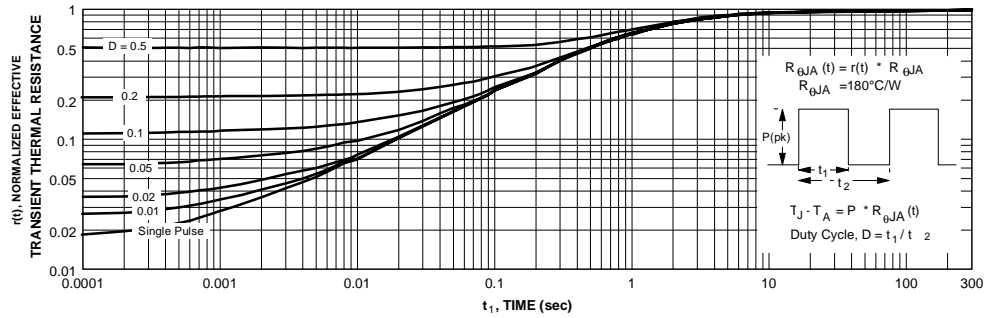
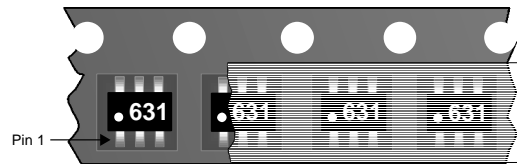
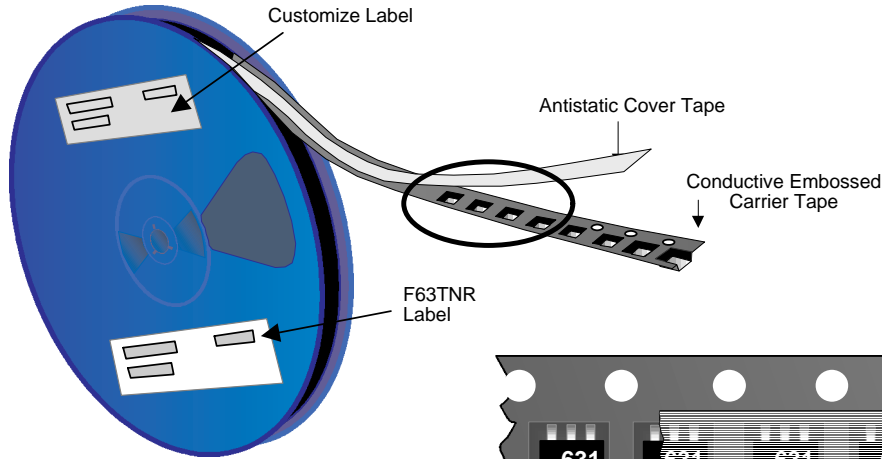

Figure 4. Transient Thermal Response Curve.

Thermal characterization performed using the conditions described in Note 2. Transient thermal response will change depending on the circuit board design.

SuperSOT™-6 Tape and Reel Data and Package Dimensions

SSOT-6 Packaging
Configuration: Figure 1.0



SSOT-6 Unit Orientation

SSOT-6 Packaging Information		
Packaging Option	Standard (no flow code)	D87Z
Packaging type	TNR	TNR
Qty per Reel/Tube/Bag	3,000	10,000
Reel Size	7" Dia	13"
Box Dimension (mm)	184x187x47	343x343x64
Max qty per Box	9,000	20,000
Weight per unit (gm)	0.0158	0.0158
Weight per Reel (kg)	0.1440	0.4700
Note/Comments		

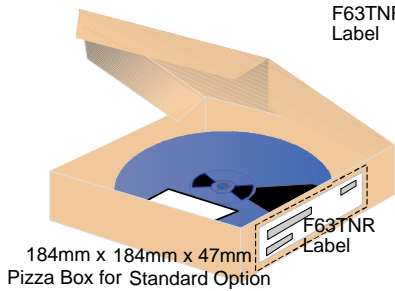
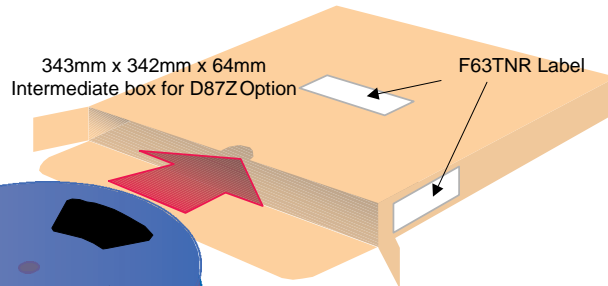

F63TNR Label sample



SSOT-6 Tape Leader Trailer Configuration: Figure 2.0

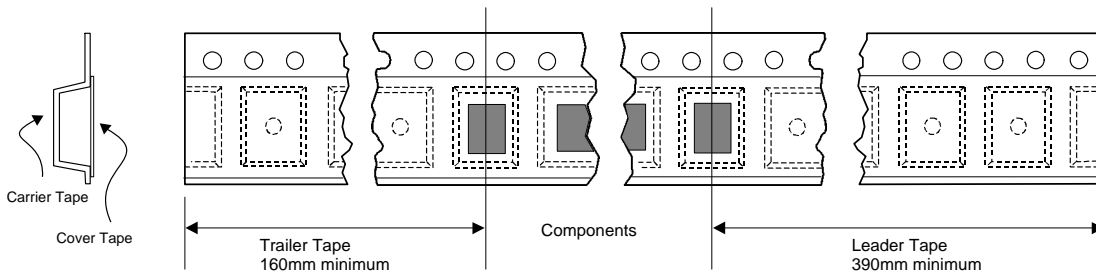

SuperSOT™-6 Tape and Reel Data and Package Dimensions, continued

SSOT-6 Embossed Carrier Tape Configuration: Figure 3.0

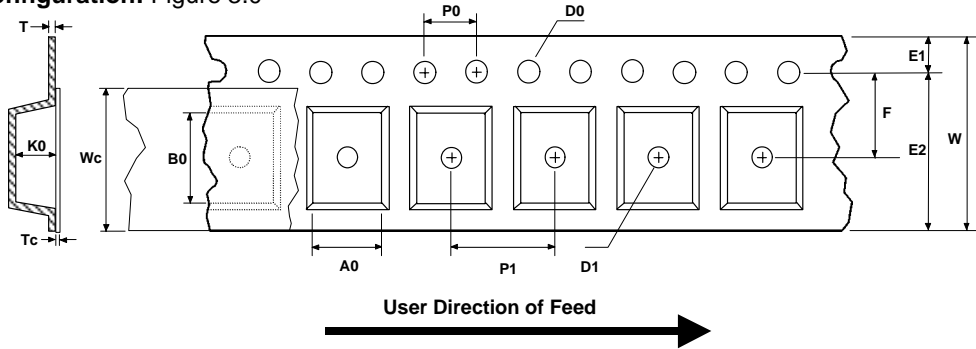

Dimensions are in millimeter														
Pkg type	A0	B0	W	D0	D1	E1	E2	F	P1	P0	K0	T	Wc	Tc
SSOT-6 (8mm)	3.23 +/-0.10	3.18 +/-0.10	8.0 +/-0.3	1.55 +/-0.05	1.00 +/-0.125	1.75 +/-0.10	6.25 min	3.50 +/-0.05	4.0 +/-0.1	4.0 +/-0.1	1.37 +/-0.10	0.255 +/-0.150	5.2 +/-0.3	0.06 +/-0.02

Notes: A0, B0, and K0 dimensions are determined with respect to the EIA/Jedec RS-481 rotational and lateral movement requirements (see sketches A, B, and C).

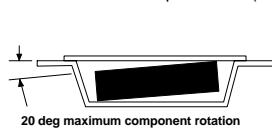

Sketch A (Side or Front Sectional View)
Component Rotation

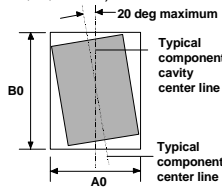

Sketch B (Top View)
Component Rotation

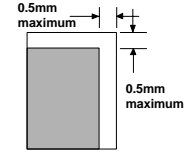

Sketch C (Top View)
Component lateral movement

SSOT-6 Reel Configuration: Figure 4.0

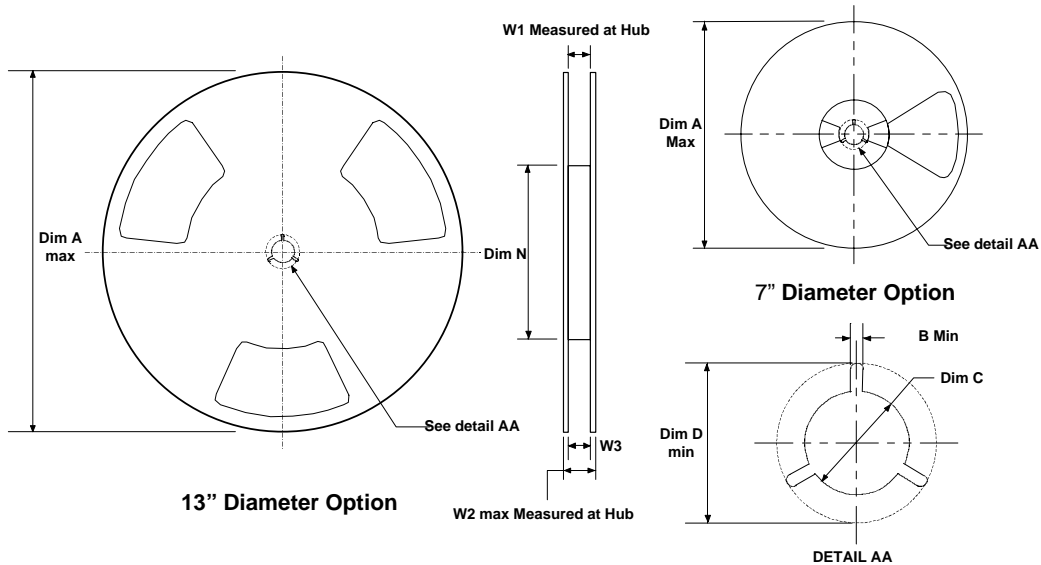

Dimensions are in inches and millimeters									
Tape Size	Reel Option	Dim A	Dim B	Dim C	Dim D	Dim N	Dim W1	Dim W2	Dim W3 (LSL-USL)
8mm	7" Dia	7.00 177.8	0.059 1.5	512 +0.020/-0.008 13 +0.5/-0.2	0.795 20.2	2.165 55	0.331 +0.059/-0.000 8.4 +1.5/0	0.567 14.4	0.311 - 0.429 7.9 - 10.9
8mm	13" Dia	13.00 330	0.059 1.5	512 +0.020/-0.008 13 +0.5/-0.2	0.795 20.2	4.00 100	0.331 +0.059/-0.000 8.4 +1.5/0	0.567 14.4	0.311 - 0.429 7.9 - 10.9

SuperSOT™-6 Tape and Reel Data and Package Dimensions, continued

SuperSOT™-6 (FS PKG Code 31, 33)

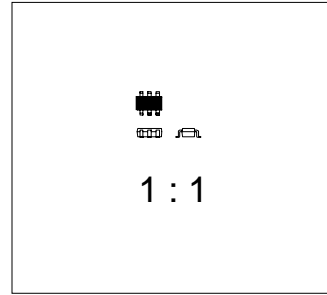
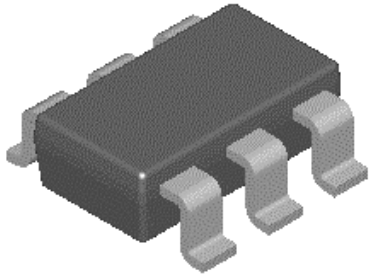

Scale 1:1 on letter size paper

Dimensions shown below are in:
inches [millimeters]

Part Weight per unit (gram): 0.0158

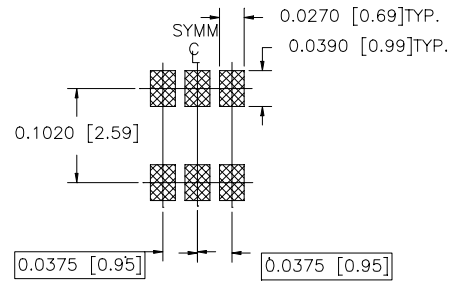
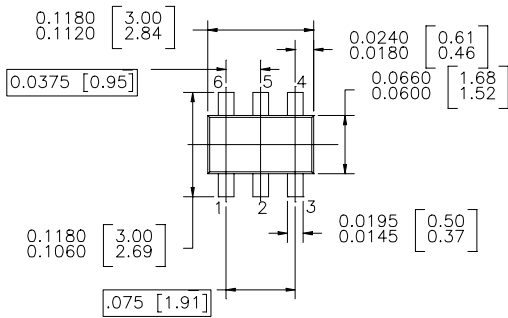

LAND PATTERN RECOMMENDATION

CONTROLLING DIMENSION IS INCH
VALUES IN [] ARE MILLIMETERS

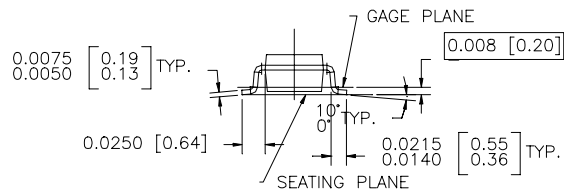
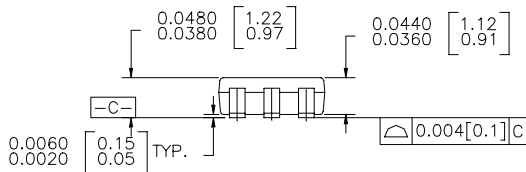

SUPER SOT 6 LEADS

NOTES : UNLESS OTHERWISE SPECIFIED

1.0 STANDARD LEAD FINISH : 150 MICRONS 93.81 MICROMETERS)
MINIMUM TIN / LEAD (SOLDER) ON COPPER.

2.0 NO JEDEC REGISTRATION AS OF JULY 1996

TRADEMARKS

The following are registered and unregistered trademarks Fairchild Semiconductor owns or is authorized to use and is not intended to be an exhaustive list of all such trademarks.

ACEx™	ISOPLANAR™
CoolFET™	MICROWIRE™
CROSSVOLT™	POP™
E ² CMOS™	PowerTrench™
FACT™	QS™
FACT Quiet Series™	Quiet Series™
FAST®	SuperSOT™-3
FASTr™	SuperSOT™-6
GTO™	SuperSOT™-8
HiSeC™	TinyLogic™

DISCLAIMER

FAIRCHILD SEMICONDUCTOR RESERVES THE RIGHT TO MAKE CHANGES WITHOUT FURTHER NOTICE TO ANY PRODUCTS HEREIN TO IMPROVE RELIABILITY, FUNCTION OR DESIGN. FAIRCHILD DOES NOT ASSUME ANY LIABILITY ARISING OUT OF THE APPLICATION OR USE OF ANY PRODUCT OR CIRCUIT DESCRIBED HEREIN; NEITHER DOES IT CONVEY ANY LICENSE UNDER ITS PATENT RIGHTS, NOR THE RIGHTS OF OTHERS.

LIFE SUPPORT POLICY

FAIRCHILD'S PRODUCTS ARE NOT AUTHORIZED FOR USE AS CRITICAL COMPONENTS IN LIFE SUPPORT DEVICES OR SYSTEMS WITHOUT THE EXPRESS WRITTEN APPROVAL OF FAIRCHILD SEMICONDUCTOR CORPORATION. As used herein:

1. Life support devices or systems are devices or systems which, (a) are intended for surgical implant into the body, or (b) support or sustain life, or (c) whose failure to perform when properly used in accordance with instructions for use provided in the labeling, can be reasonably expected to result in significant injury to the user.
2. A critical component is any component of a life support device or system whose failure to perform can be reasonably expected to cause the failure of the life support device or system, or to affect its safety or effectiveness.

PRODUCT STATUS DEFINITIONS

Definition of Terms

Datasheet Identification	Product Status	Definition
Advance Information	Formative or In Design	This datasheet contains the design specifications for product development. Specifications may change in any manner without notice.
Preliminary	First Production	This datasheet contains preliminary data, and supplementary data will be published at a later date. Fairchild Semiconductor reserves the right to make changes at any time without notice in order to improve design.
No Identification Needed	Full Production	This datasheet contains final specifications. Fairchild Semiconductor reserves the right to make changes at any time without notice in order to improve design.
Obsolete	Not In Production	This datasheet contains specifications on a product that has been discontinued by Fairchild semiconductor. The datasheet is printed for reference information only.