

100V, 30A Schottky barrier diode in TO220F package

FME-230A

Absolute maximum ratings

Parameter	Ratings	Unit	Conditions
V_{RM}	100	V	
$I_{F(AV)}$	30	A	
I_{FSM}	150	A	10ms Half-cycle sinewave Single Shot
I^2t	112	A ² s	
T_j	-40 to +150	°C	
T_{stg}	-40 to +150	°C	

Electrical characteristics

($T_a=25^\circ\text{C}$)

Parameter	Ratings	Unit	Conditions
V_F	0.85	V	$I_F=15\text{A}$
I_R	1.5max	mA	$V_R=V_{RM}$
H.I.R	150max	mA	$T_j=150^\circ\text{C}$, $V_R=V_{RM}$
$R_{th(j-c)}$	4.0max	°C/W	Junction-to-case

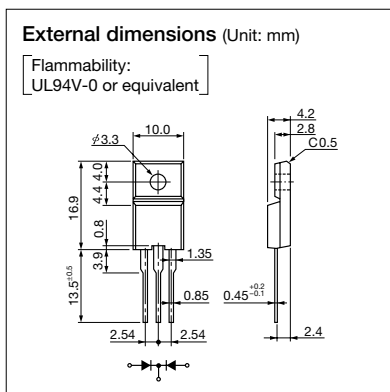
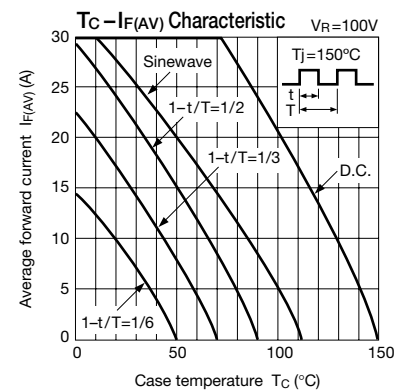
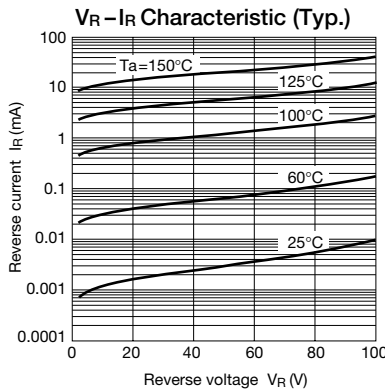
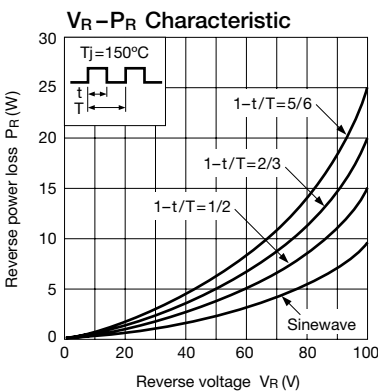
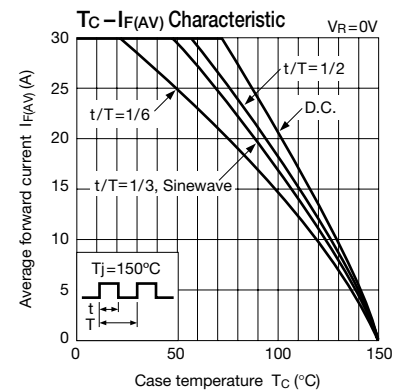
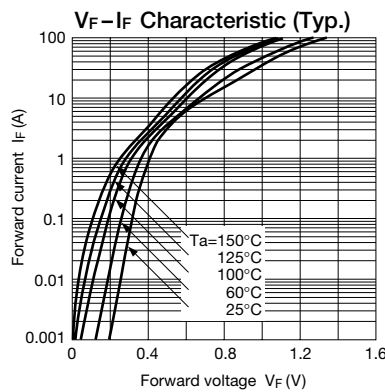
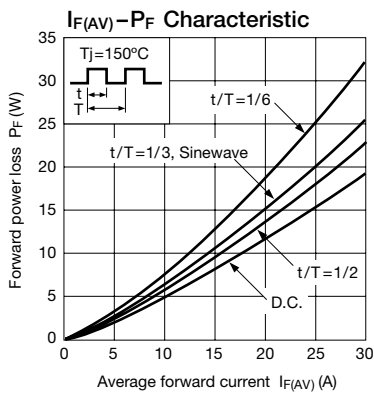

Reference data

