

FMS6151

Ultra Portable Video Filter Driver

Features

- 5th order 8MHz (SD) filter
- Power down to 25nA
- DC coupled input
- AC or DC coupled output
- DC coupled output eliminate need for AC coupling cap
- SAG correction reduces size of AC coupling cap
- Fixed gain of 6dB
- Small, lead (Pb) free, Micropak® packaging

Applications

- Digital Still Cameras
- Camera Phones
- Personal Digital Assistants
- Set Top Boxes
- Digital Video Recorders

Description

The FMS6151 low cost, integrated, video filter is intended to replace passive LC filters and drivers in low voltage portable video applications. The 5th order filter provides better image quality compared to typical 2nd and 3rd order passive solutions.

The FMS6151 is intended to be directly driven by a DC-coupled DAC output. The output can drive an AC or DC-coupled doubly terminated coax(150Ω) load. DC-coupling the output removes the need for an expensive output coupling capacitor. If an AC-coupled output is needed, the SAG correction circuit can be used to reduce the AC output coupling capacitor value. Input DC levels are offset by approximately 100mV. This internal level shift is incorporated to prevent sync pulse clipping.

Offering SAG correction, fixed gain of 6dB, and a 5th order low pass filter in a tiny space saving package (Micropak) makes the FMS6151 well suited for space sensitive applications such as cellular phones and digital cameras.

Block Diagram

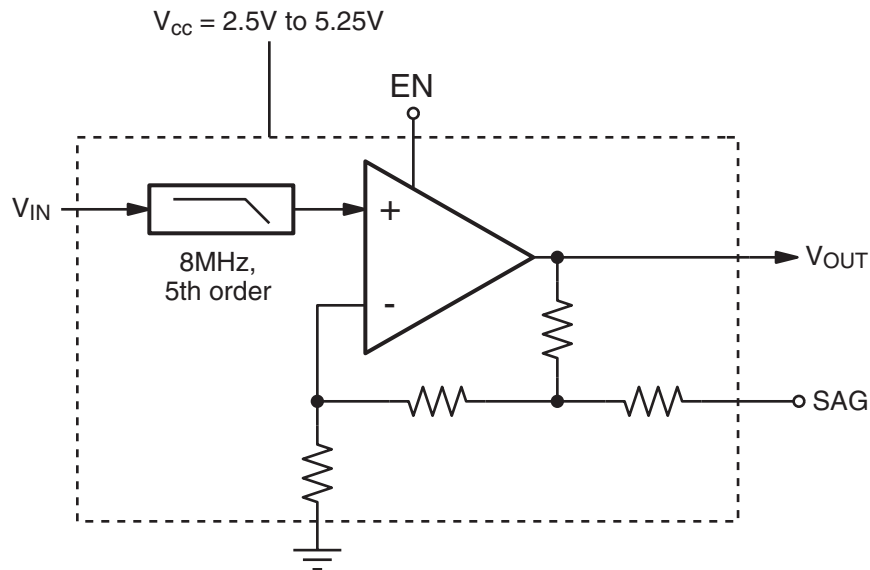

Pin Configuration

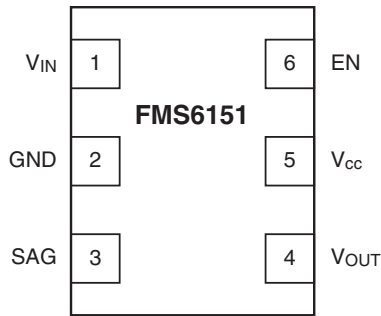

Pin Assignments

Pin#	Pin	Type	Description
1	V _{IN}	Input	Video Input
2	GND	Input	Ground
3	SAG	Input	SAG
4	V _{OUT}	Output	Filtered Video Output
5	V _{CC}	Input	Positive Power Supply
6	EN	Input	Enable 0=Disabled 1=Enabled

Absolute Maximum Ratings

Parameter	Min.	Max.	Unit
DC Supply Voltage	-0.3	6	V
Analog and Digital I/O	-0.3	V _{CC} + 0.3	V
Maximum Output Current, Do Not Exceed		45	mA

Reliability Information

Parameter	Min.	Typ.	Max.	Unit
Junction Temperature			150	°C
Storage Temperature Range	-65		150	°C
Thermal Resistance (ThetaJA), JEDEC Standard Multi-Layer Test Boards, Still Air		271		°C/W

Recommended Operating Conditions

Parameter	Min.	Typ.	Max.	Unit
Operating Temperature Range	-40		85	°C
Supply Voltage Range	2.5	3.3	5.25	V

DC Electrical Characteristics

$T_C = 25^\circ\text{C}$, $V_{CC} = 2.7\text{V}$, $R_S = 37.5\Omega$, AC coupled output into 150Ω load, SAG pin connected to V_{OUT} pin; unless otherwise noted.

Symbol	Parameter	Conditions	Min.	Typ.	Max	Units
I_{CC}	Supply Current ¹	$V_{CC} = 2.7\text{V}$, No load		3.8	6.4	mA
V_{in}	Video Input Voltage Range	Referenced to GND		1.2		V _{pp}
Vols	Output Level Shift ¹	$V_{in} = 0\text{V}$	50	200	350	mV
PSRR	Vols over power supply	$V_{CC} = 2.7\text{V}$ to 3.3V		40		dB
I_{SH}	Shut Down Current			25		nA
V_{il}	Disabled Logic Low ¹		0		0.8	V
V_{ih}	Enabled Logic High ¹		$V_{CC} \cdot 0.6$		V_{CC}	V
t_{ON}	Enable Time			1.5		us
t_{OFF}	Disable Time			50		ns

AC Electrical Characteristics

$T_C = 25^\circ\text{C}$, $V_{CC} = 2.7\text{V}$, $R_S = 37.5\Omega$, AC coupled output into 150Ω load, SAG pin connected to V_{OUT} pin; unless otherwise noted.

Symbol	Parameter	Conditions	Min.	Typ.	Max	Units
A_V	Gain ¹	DC	5.6	6.0	6.6	dB
f_{1dB}	-1dB Bandwidth ¹		5.0	6.7		MHz
f_c	-3dB Bandwidth			8		MHz
f_{SB}	Attenuation ¹ (stopband reject)	27MHz	40	47		dB
DG	Differential Gain			0.5		%
DP	Differential Phase			0.5		°
SNR	Signal-to-Noise Ratio	NTC-7 weighting, 100kHz to 4.2MHz		78		dB

Notes:

1. 100% tested at 25°C

Typical Performance Characteristics

$T_C = 25^\circ\text{C}$, $V_{CC} = 2.7\text{V}$, $R_S = 37.5\Omega$, AC coupled output into 150Ω load, SAG pin connected to V_{OUT} pin; unless otherwise noted.

Figure 1. Frequency Response

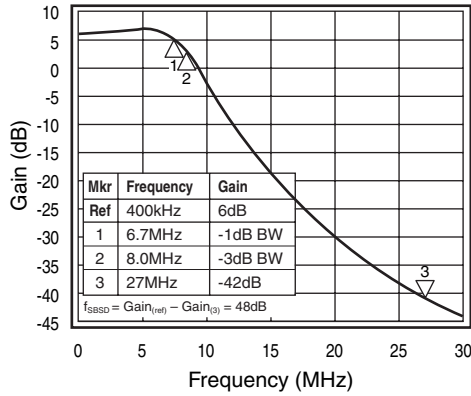

Figure 2. Gain Error vs. Temp.

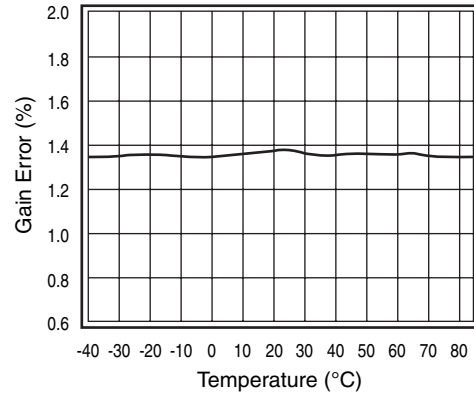

Figure 3. Enable/Disable Response

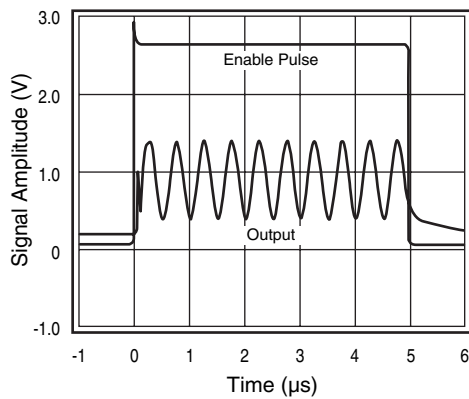

Figure 4. Differential Gain

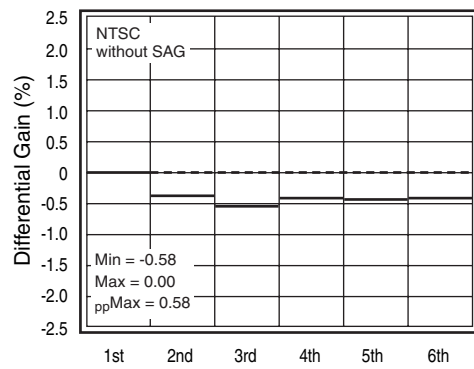

Figure 5. I_{CC} vs. Supply Voltage

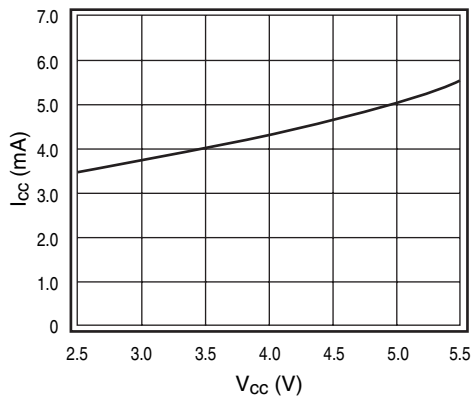
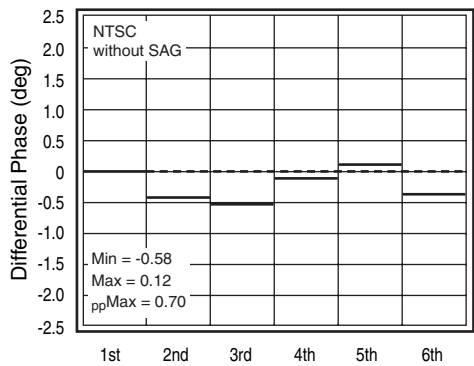

Figure 6. Differential Phase



Typical Performance Characteristics

$T_C = 25^\circ\text{C}$, $V_{CC} = 2.7\text{V}$, $R_S = 37.5\Omega$, AC coupled output into 150Ω load, SAG pin connected to V_{OUT} pin; unless otherwise noted.

Figure 7. Supply Current vs. Temp.

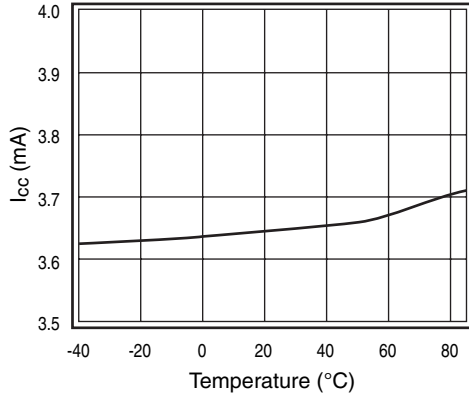
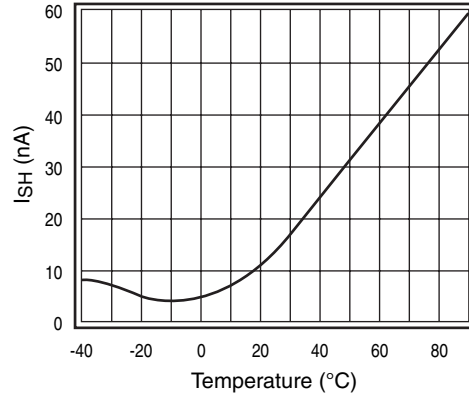

Figure 8. Shutdown Current vs. Temp.



Application Information

Input Voltage

The FMS6151 is intended to be directly driven by a DC coupled DAC output. The input common mode range of the FMS6151 is $1.2V_{pp}$, ground referenced.

Enable/Shutdown

The FMS6151 has a shutdown feature that disables the output and reduces the quiescent current to $\sim 25\text{nA}$. This feature is especially useful in portable applications, such as cellular phones, hand held gaming devices, and video cameras requiring video filtering and drive capability.

Internal Level Shift

The FMS6151 has an internal level shift circuit to avoid sync tip clipping. The output signal is shifted 200mV toward the V_{CC} rail to help prevent clipping. This offset is extremely useful when DC coupled out or using SAG correction.

SAG Correction

Sag correction provides excellent performance with a small output coupling capacitor. It eliminates the $220\mu\text{F}$ - $1000\mu\text{F}$ output coupling capacitors traditionally used. The traditional output circuit

($220\mu\text{F}$ into 150Ω load) creates a single pole (-3dB) at 5Hz . Reducing this capacitor causes excessive phase shift, resulting in video field tilt which can prevent proper recovery of the synchronization signals.

The FMS6151 sag correction circuit provides a small amount of peaking, which provides compensation of the phase response, significantly reducing video field tilt. The SAG correction circuit allows you to decrease the large, $220\mu\text{F}$, output coupling capacitor. A $22\mu\text{F}$ is used for sag correction and a $47\mu\text{F}$ is used for the output coupling capacitor, extremely smaller and cheaper than the traditional circuit requirements.

Output Configuration

The FMS6151 output is a low impedance voltage driver. It is capable of driving an AC or DC coupled single load.

For more application information, please refer to our FMS6151 Application Note, AN-8005.

Mechanical Dimensions

6-Lead MicroPak Package

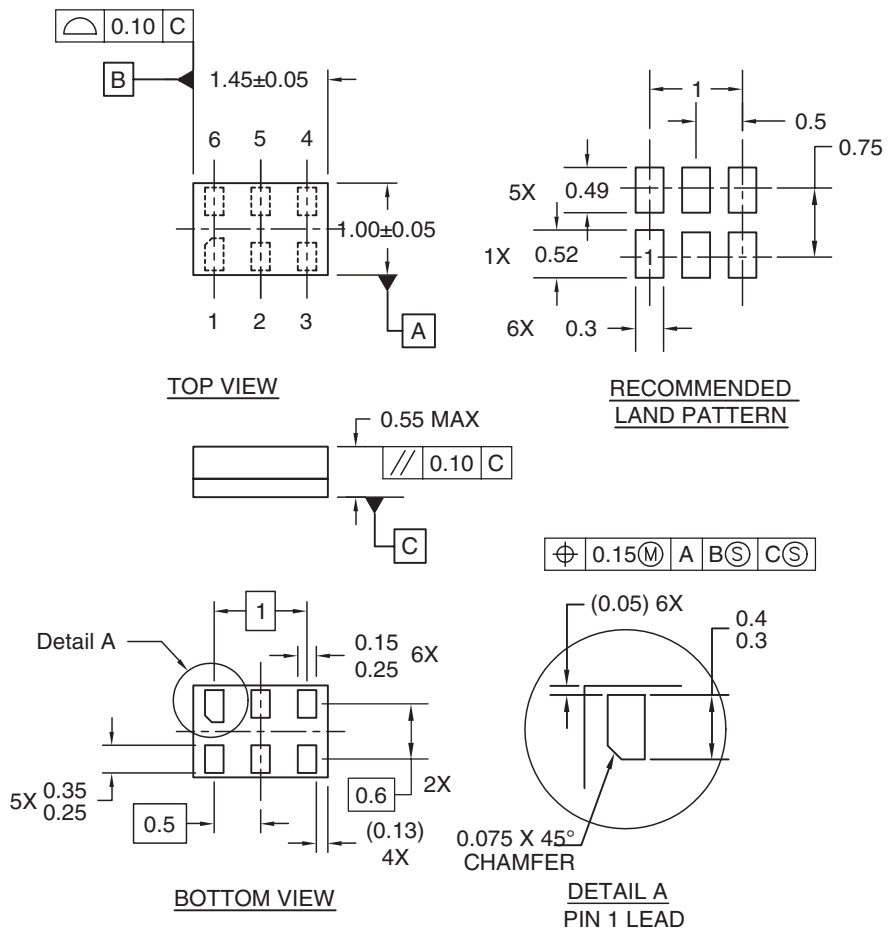

NOTES

1. JEDEC PACKAGE REGISTRATION IS ANTICIPATED
2. DIMENSIONS ARE IN MILLIMETERS
3. THIS DRAWING IS PRELIMINARY AND SUBJECT TO CHANGE
4. DRAWING CONFORMS TO ASME Y14.5M-1994

Ordering Information

Model	Part Number	Lead Free	Package	Container	Pack Qty
FMS6151	FMS6151L6X	Yes	uPAK-6	Reel	5000

Temperature range for all parts: -40°C to 85°C.

DISCLAIMER

FAIRCHILD SEMICONDUCTOR RESERVES THE RIGHT TO MAKE CHANGES WITHOUT FURTHER NOTICE TO ANY PRODUCTS HEREIN TO IMPROVE RELIABILITY, FUNCTION OR DESIGN. FAIRCHILD DOES NOT ASSUME ANY LIABILITY ARISING OUT OF THE APPLICATION OR USE OF ANY PRODUCT OR CIRCUIT DESCRIBED HEREIN; NEITHER DOES IT CONVEY ANY LICENSE UNDER ITS PATENT RIGHTS, NOR THE RIGHTS OF OTHERS.

LIFE SUPPORT POLICY

FAIRCHILD'S PRODUCTS ARE NOT AUTHORIZED FOR USE AS CRITICAL COMPONENTS IN LIFE SUPPORT DEVICES OR SYSTEMS WITHOUT THE EXPRESS WRITTEN APPROVAL OF FAIRCHILD SEMICONDUCTOR CORPORATION. As used herein:

- | | |
|---|---|
| <p>1. Life support devices or systems are devices or systems which, (a) are intended for surgical implant into the body, or (b) support or sustain life, or (c) whose failure to perform when properly used in accordance with instructions for use provided in the labeling, can be reasonably expected to result in significant injury to the user.</p> | <p>2. A critical component is any component of a life support device or system whose failure to perform can be reasonably expected to cause the failure of the life support device or system, or to affect its safety or effectiveness.</p> |
|---|---|