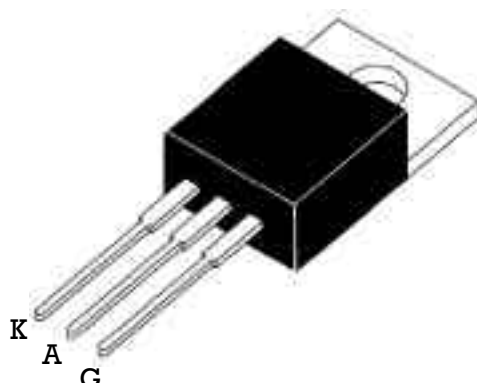

STANDARD SCR

<p>TO220-AB</p> 	<p>On-State Current 16 Amp</p> <p>Gate Trigger Current > 2 mA to < 40 mA</p> <p>Off-State Voltage 200 V ÷ 600 V</p>
<p>These series of Silicon Controlled Rectifier use a high performance PNPN technology.</p> <p>These parts are intended for general purpose high current applications where moderate gate insensitivity is required.</p>	

Absolute Maximum Ratings, according to IEC publication No. 134

SYMBOL	PARAMETER	CONDITIONS	Min.	Max.	Unit
$I_{T(RMS)}$	On-state Current	180° Conduction Angle, $T_c = 110\text{ °C}$		16	A
$I_{T(AV)}$	Average On-state Current	Half Cycle, $= 180\text{ °}$, $T_c = 110\text{ °C}$		10	A
I_{TSM}	Non-repetitive On-State Current	Half Cycle, 60 Hz		200	A
I_{TSM}	Non-repetitive On-State Current	Half Cycle, 50 Hz		190	A
I^2t	Fusing Current	$t_p = 10\text{ms}$, Half Cycle		180	A ² s
V_{GRM}	Peak Reverse Gate Voltage	$I_{GR} = 10\text{ }\mu\text{A}$		5	V
I_{GM}	Peak Gate Current	20 μs max.		4	A
P_{GM}	Peak Gate Dissipation	20 μs max.		10	W
$P_{G(AV)}$	Gate Dissipation	20ms max.		1	W
T_j	Operating Temperature		-40	+125	°C
T_{stg}	Storage Temperature		-40	+150	°C
T_{sld}	Soldering Temperature	10s max.		260	°C

SYMBOL	PARAMETER	CONDITIONS	VOLTAGE			Unit
			B	D	M	
V_{DRM} V_{RRM}	Repetitive Peak Off State Voltage	$R_{GK} = 1\text{ K}$	200	400	600	V

STANDARD SCR

Electrical Characteristics

SYMBOL	PARAMETER	CONDITIONS	SENSITIVITY		Unit
			10	14	
I_{GT}	Gate Trigger Current	$V_D = 12 V_{DC}, R_L = 33 \Omega, T_j = 25^\circ C$	MIN MAX	2 4 25 40	mA
I_{DRM} / I_{RRM}	Off-State Leakage Current	$V_D = V_{DRM}, R_{CK} = 220 \Omega, T_j = 125^\circ C$ $V_R = V_{RRM}, T_j = 25^\circ C$	MAX MAX	2 5	mA μA
V_{TM}	On-state Voltage	at $I_T = 32 \text{ Amp}, t_p = 380 \mu s, T_j = 25^\circ C$	MAX	1.6	V
V_{GT}	Gate Trigger Voltage	$V_D = 12 V_{DC}, R_L = 33 \Omega, T_j = 25^\circ C$	MAX	1.3	V
V_{GD}	Gate Non Trigger Voltage	$V_D = V_{DRM}, R_L = 3.3K, T_j = 125^\circ C$	MIN	0.2	V
I_H	Holding Current	$I_T = 500 \text{ mA}, \text{ Gate open}, T_j = 25^\circ C$	MAX	40 50	mA
I_L	Latching Current	$I_G = 1.2 I_{GT}$	MAX	60 90	mA
dv / dt	Critical Rate of Voltage Rise	$V_D = 0.67 \times V_{DRM}, \text{ Gate open } T_j = 125^\circ C$	MIN	500 1000	V/ μs
di / dt	Critical Rate of Current Rise	$I_G = 2 \times I_{GT}, t_r = 100 \text{ ns}, F = 60 \text{ Hz}, T_j = 125^\circ C$	MIN	50	A/ μs
$R_{th(j-c)}$	Thermal Resistance Junction-Case for DC			1.1	$^\circ C/W$
$R_{th(j-a)}$	Thermal Resistance Junction-Amb			60	$^\circ C/W$
V_{10}	Threshold Voltage	$T_j = 125^\circ C$	MAX	0.77	V
R_d	Dynamic resistance	$T_j = 125^\circ C$	MAX	23	m

PART NUMBER INFORMATION

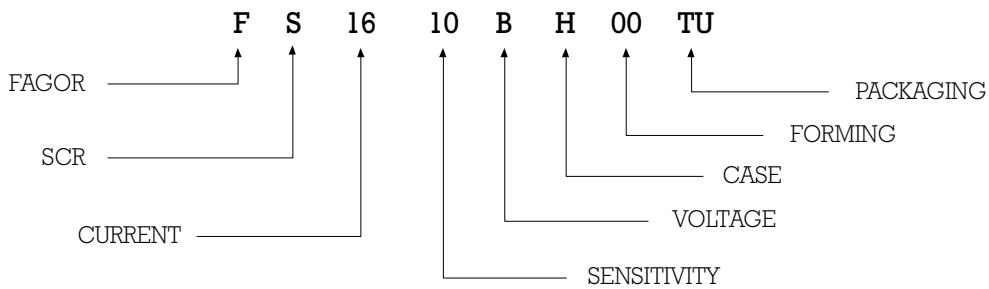

STANDARD SCR

Fig. 1: Maximum average power dissipation versus average on-state current.

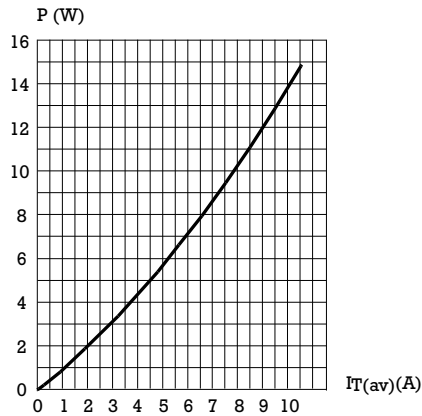

Fig. 2: Average and D.C. on-state current versus case temperature.

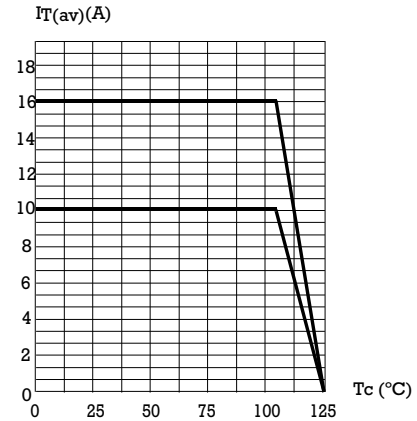

Fig. 3: Relative variation of thermal impedance junction to case versus pulse duration.

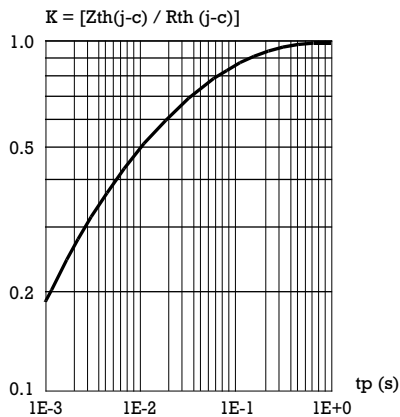

Fig. 4: Relative variation of gate trigger current, holding current and latching current versus junction temperature.

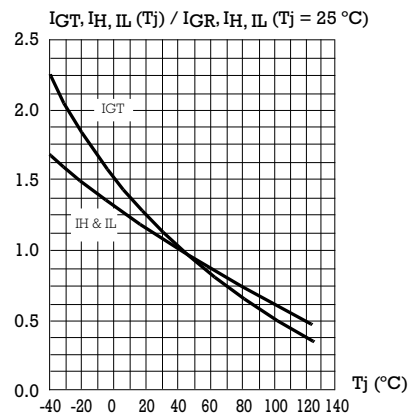
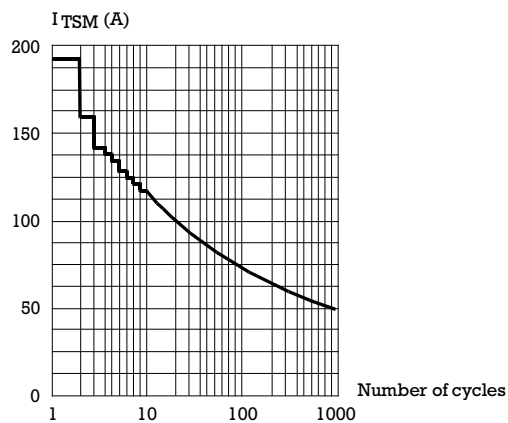
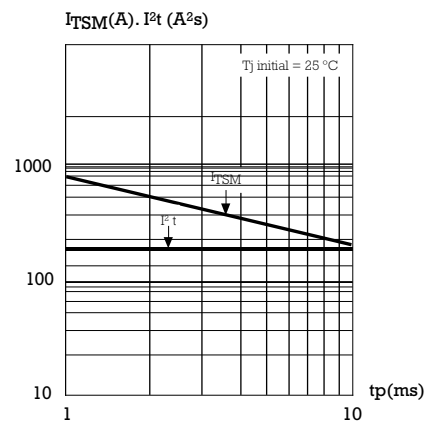
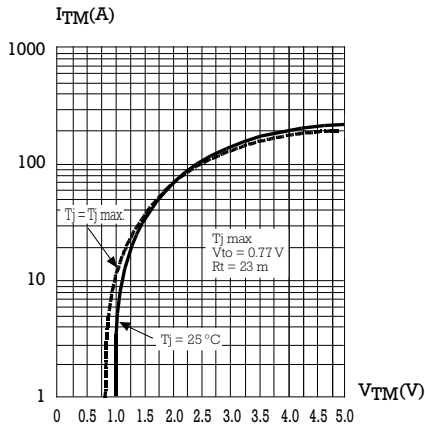

Fig. 5: Surge peak on-state current versus number of cycles.

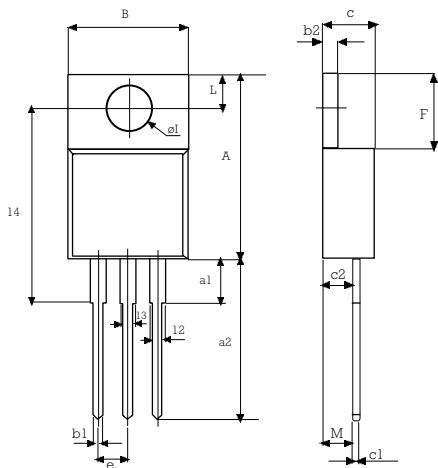

 Fig. 7: Non repetitive surge peak on-state current for a sinusoidal pulse with width: $t_p < 10$ ms, and corresponding value of I^2t .

STANDARD SCR

Fig. 8: On-state characteristics (maximum values).



PACKAGE MECHANICAL DATA TO-220AB



REF.	DIMENSIONS		
	Milimeters		
	Min.	Nominal	Max.
A	15.20		15.90
a1		3.75	
a2	13.00		14.00
B	10.00		10.40
b1	0.61		0.88
b2	1.23		1.32
C	4.40		4.60
c1	0.49		0.70
c2	2.40		2.72
e	2.40		2.70
F	6.20		6.60
I	3.75		3.85
I4	15.80	16.40	16.80
L	2.65		2.95
I2	1.14		1.70
I3	1.14		1.70
M		2.60	