

PRELIMINARY
 Notice: This is not a final specification.
 Some parametric limits are subject to change.

MITSUBISHI Nch POWER MOSFET

FS16UMA-4A

HIGH-SPEED SWITCHING USE

FS16UMA-4A

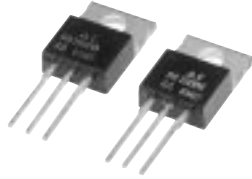

- 10V DRIVE
- V_{DSS} 200V
- $r_{DS(ON)}(MAX)$ 0.25Ω
- I_D 16A

OUTLINE DRAWING

Dimensions in mm

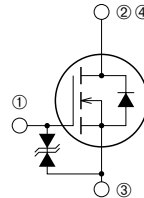
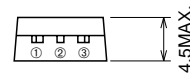
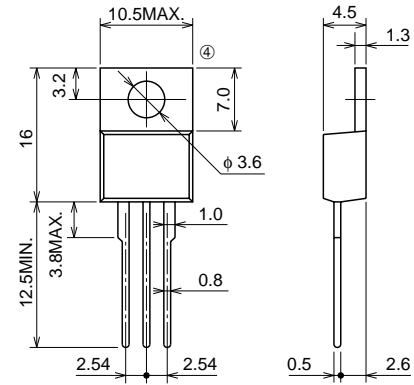

- ① GATE
- ② DRAIN
- ③ SOURCE
- ④ DRAIN

TO-220

APPLICATION

Cs Switch for CRT Display monitor, Switch mode power supply, etc.

MAXIMUM RATINGS (Tc = 25°C)

Symbol	Parameter	Conditions	Ratings	Unit
V_{DSS}	Drain-source voltage	$V_{GS} = 0V$	200	V
V_{GSS}	Gate-source voltage	$V_{DS} = 0V$	± 20	V
I_D	Drain current		16	A
I_{DM}	Drain current (Pulsed)		48	A
I_{DA}	Avalanche drain current (Pulsed)	$L = 200\mu H$	16	A
P_D	Maximum power dissipation		65	W
T_{ch}	Channel temperature		-55 ~ +150	°C
T_{stg}	Storage temperature		-55 ~ +150	°C
—	Weight	Typical value	2.0	g

Sep.1998

PRELIMINARY
 Notice: This is not a final specification.
 Some parametric limits are subject to change.

ELECTRICAL CHARACTERISTICS (Tch = 25°C)

Symbol	Parameter	Test conditions	Limits			Unit
			Min.	Typ.	Max.	
V (BR) DSS	Drain-source breakdown voltage	Id = 1mA, Vds = 0V	200	—	—	V
V (BR) GSS	Gate-source breakdown voltage	Igs = ±10μA, Vds = 0V	±20	—	—	V
IgSS	Gate-source leakage current	Vgs = ±20V, Vds = 0V	—	—	±10	μA
IdSS	Drain-source leakage current	Vds = 200V, Vgs = 0V	—	—	1	mA
VGS (th)	Gate-source threshold voltage	Id = 1mA, Vds = 10V	2.0	3.0	4.0	V
rDS (ON)	Drain-source on-state resistance	Id = 8A, Vgs = 10V	—	0.20	0.25	Ω
VDS (ON)	Drain-source on-state voltage	Id = 8A, Vgs = 10V	—	1.60	2.00	V
yfs	Forward transfer admittance	Id = 8A, Vds = 10V	—	13.0	—	S
Ciss	Input capacitance	Vds = 25V, Vgs = 0V, f = 1MHz	—	1150	—	pF
Coss	Output capacitance		—	145	—	pF
Crss	Reverse transfer capacitance		—	45	—	pF
td (on)	Turn-on delay time	VDD = 100V, Id = 8A, Vgs = 10V, RGEN = RGS = 50Ω	—	20	—	ns
tr	Rise time		—	30	—	ns
td (off)	Turn-off delay time		—	170	—	ns
tf	Fall time		—	50	—	ns
VSD	Source-drain voltage	Is = 8A, Vgs = 0V	—	0.95	—	V
Rth (ch-c)	Thermal resistance	Channel to case	—	—	1.92	°C/W

PERFORMANCE CURVES

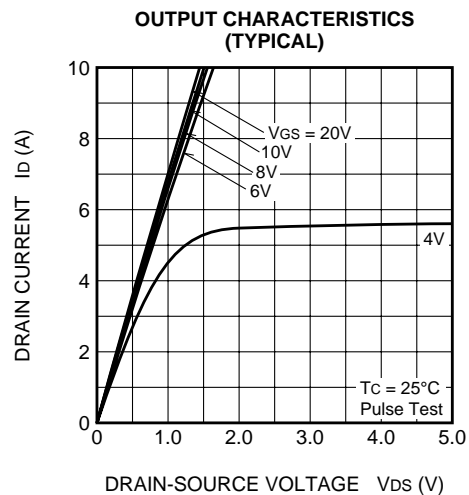
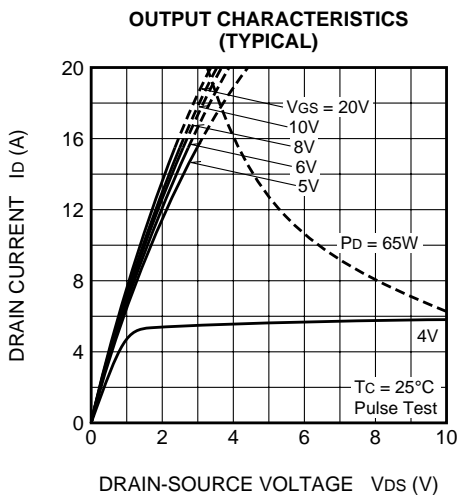
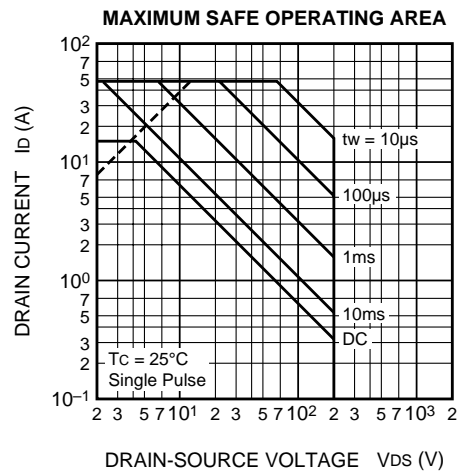
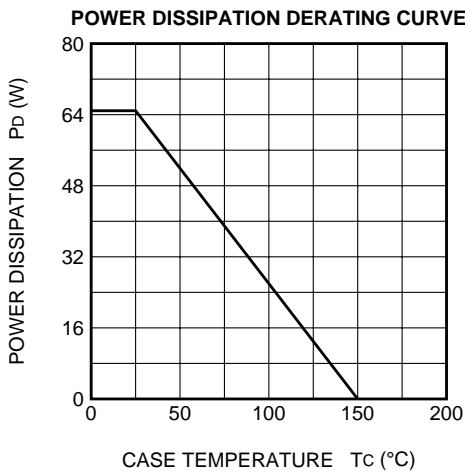

PRELIMINARY
 Notice: This is not a final specification.
 Some parametric limits are subject to change.

ON-STATE VOLTAGE VS. GATE-SOURCE VOLTAGE (TYPICAL)

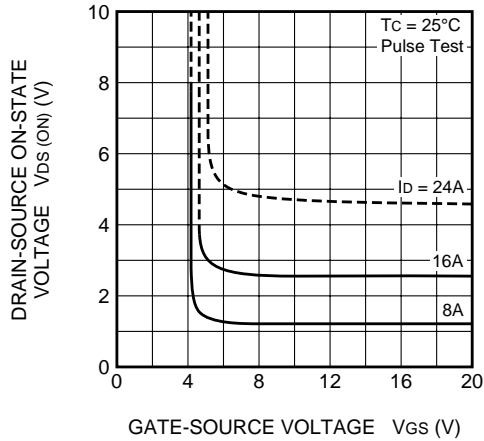

ON-STATE RESISTANCE VS. DRAIN CURRENT (TYPICAL)

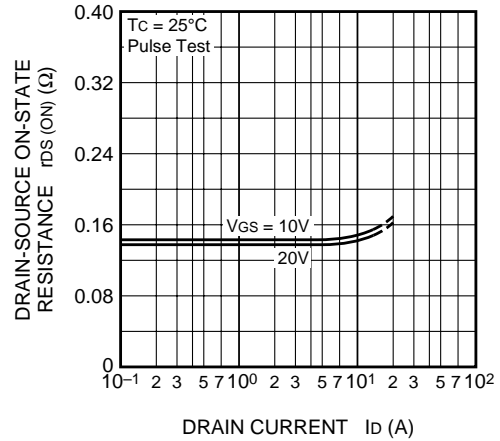

TRANSFER CHARACTERISTICS (TYPICAL)

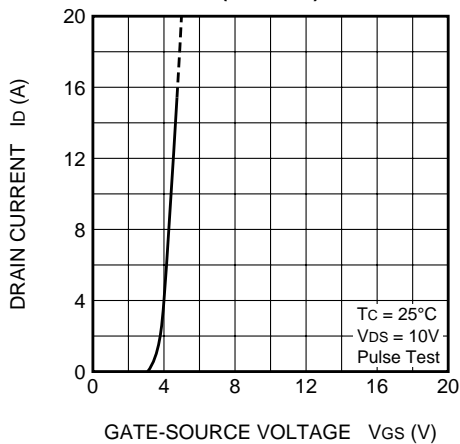

FORWARD TRANSFER ADMITTANCE VS. DRAIN CURRENT (TYPICAL)

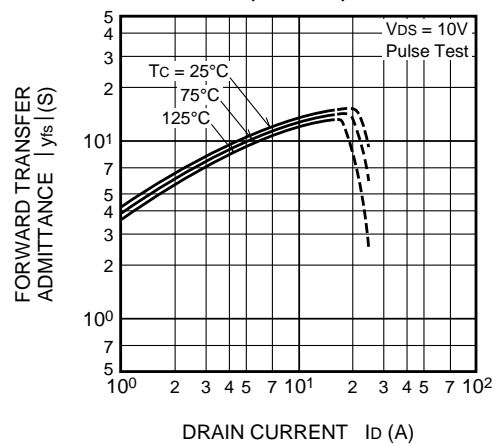

CAPACITANCE VS. DRAIN-SOURCE VOLTAGE (TYPICAL)

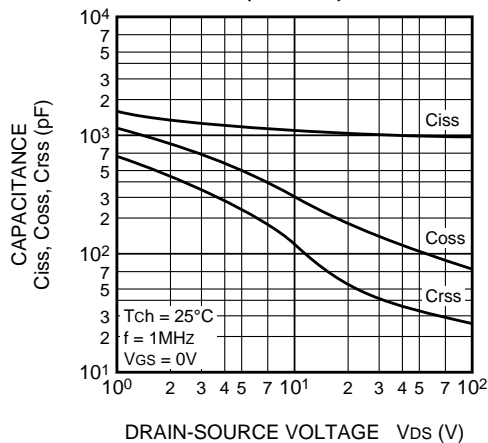

SWITCHING CHARACTERISTICS (TYPICAL)

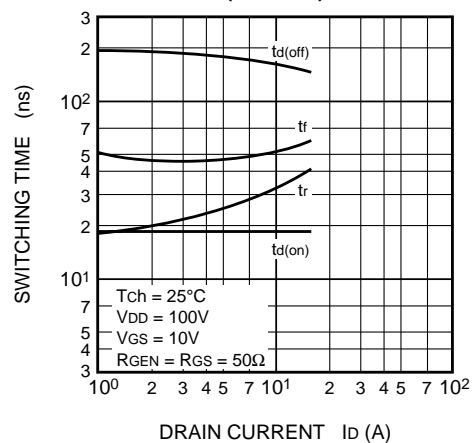

PRELIMINARY
 Notice: This is not a final specification.
 Some parametric limits are subject to change.

GATE-SOURCE VOLTAGE VS. GATE CHARGE (TYPICAL)

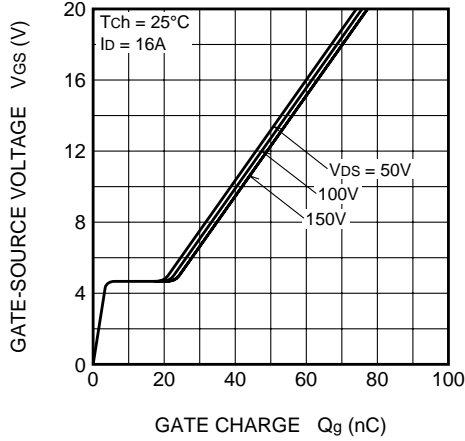

SOURCE-DRAIN DIODE FORWARD CHARACTERISTICS (TYPICAL)

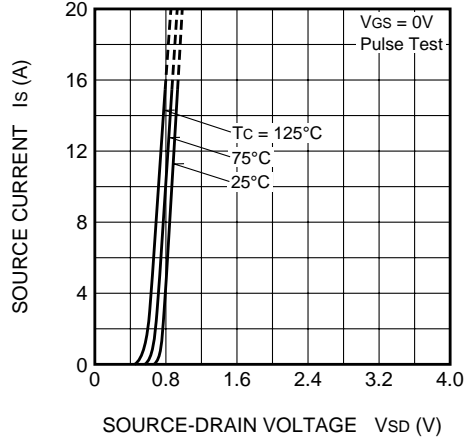

ON-STATE RESISTANCE VS. CHANNEL TEMPERATURE (TYPICAL)

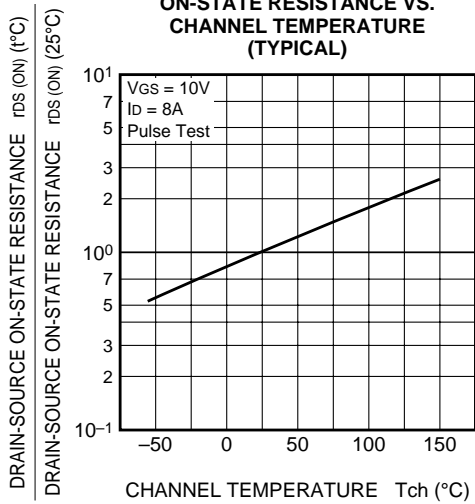

THRESHOLD VOLTAGE VS. CHANNEL TEMPERATURE (TYPICAL)

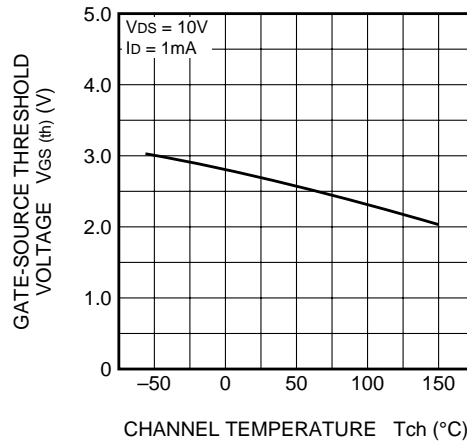

BREAKDOWN VOLTAGE VS. CHANNEL TEMPERATURE (TYPICAL)

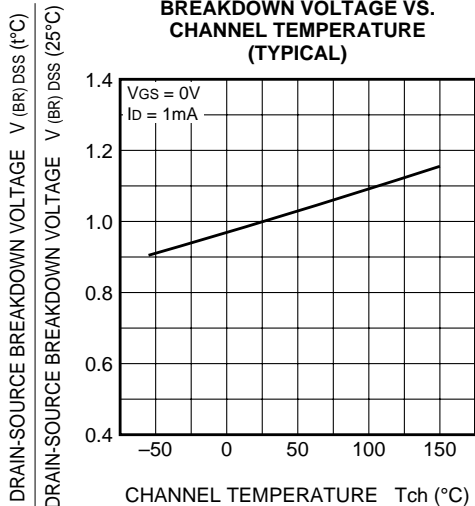

TRANSIENT THERMAL IMPEDANCE CHARACTERISTICS

