

FSA266 • NC7WB66

Low Voltage Dual SPST Normally Open Analog Switch or 2-Bit Bus Switch

General Description

The FSA266 or NC7WB66 is an ultra high-speed (UHS) dual single-pole/single-throw (SPST) analog switch or 2-bit bus switch. The device is fabricated with advanced sub-micron CMOS technology to achieve high speed enable and disable times and low On Resistance over a broad V_{CC} range. The device is specified to operate over the 1.65 to 5.5V V_{CC} operating range. The device is organized as a dual switch with independent CMOS compatible switch enable (OE) controls. When OE is HIGH, the switch is ON and Port A is connected to Port B. When OE is LOW, the switch is OPEN and a high-impedance state exists between the two ports. The enable inputs tolerate voltages up to 5.5V independent of the V_{CC} operating range.

Features

- Useful in both analog and digital applications
- Space saving US8 surface mount package
- MicroPak™ Pb-Free leadless package
- Typical 7Ω On Resistance @ 5V V_{CC}
- Broad V_{CC} operating range: 1.65V to 5.5V
- Rail-to-Rail signal handling
- Power down high impedance control inputs
- Control inputs are overvoltage tolerant
- Control inputs are CMOS compatible
- >300 MHz -3dB bandwidth

Ordering Code:

Order Number	Package Number	Product Code Top Mark	Package Description	Supplied As
FSA266K8X	MAB08A	WB66	8-Lead US8, JEDEC MO-187, Variation CA 3.1mm Wide	3K Units on Tape and Reel
FSA266L8X	MAC08A	P4	Pb-Free 8-Lead MicroPak, 1.6 mm Wide	5K Units on Tape and Reel
NC7WB66K8X	MAB08A	WB66	8-Lead US8, JEDEC MO-187, Variation CA 3.1mm Wide	3K Units on Tape and Reel
NC7WB66L8X	MAC08A	P4	Pb-Free 8-Lead MicroPak, 1.6 mm Wide	5K Units on Tape and Reel

Pb-Free package per JEDEC J-STD-020B.

MicroPak™ is a trademark of Fairchild Semiconductor Corporation.

Logic Symbol

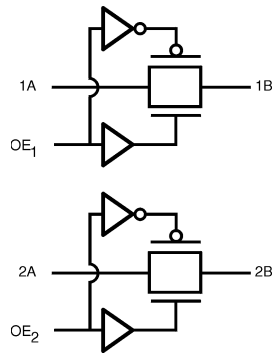

Analog Symbol

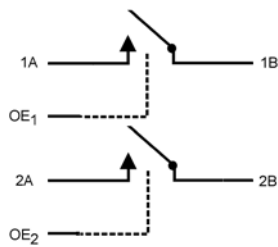

Pin Descriptions

Pin Names	Description
A	Switch Port A
B	Switch Port B
OE	Control Input

Function Table

Switch Enable Input (OE)	Function
L	Disconnect
H	B Connected to A

H = HIGH Logic Level
L = LOW Logic Level

Connection Diagrams

Pin Assignments for US8

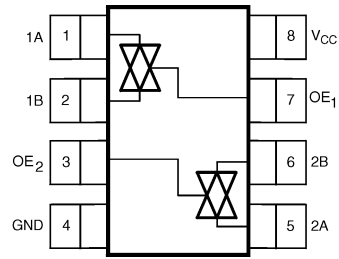

(Top View)

Pad Assignments for MicroPak

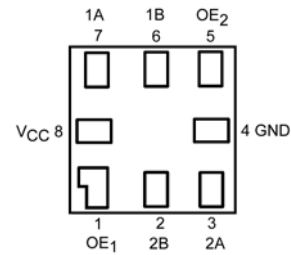

(Top Through View)

Absolute Maximum Ratings (Note 1)

Supply Voltage (V_{CC})	-0.5V to +7.0V
DC Switch Voltage (V_S)	-0.5V to $V_{CC} + 0.5V$
DC Input Voltage (V_{IN}) (Note 2)	-0.5V to +7.0V
DC Input Diode Current @ $(I_{IK}) V_{IN} < 0V$	-50 mA
DC Switch Output Current (I_{OUT})	± 128 mA
DC V_{CC} or Ground Current (I_{CC}/I_{GND})	± 100 mA
Storage Temperature Range (T_{STG})	-65°C to +150°C
Junction Lead Temperature under Bias (T_J)	+150°C
Junction Lead Temperature (T_L) (Soldering, 10 Seconds)	+260°C
Power Dissipation (P_D) @ +85°C SC70-6	250 mW

Recommended Operating Conditions (Note 3)

Supply Voltage (V_{CC})	1.65V to 5.5V
Control Input Voltage (V_{IN})	0V to 5.5V
Switch Input Voltage (V_{IN})	0V to V_{CC}
Switch Output Voltage (V_{OUT})	0V to V_{CC}
Operating Temperature (T_A)	-40°C to +85°C
Input Rise and Fall Time (t_r, t_f)	
Control Input $V_{CC} = 1.65V-2.7V$	0 ns/V to 20 ns/V
Control Input $V_{CC} = 3.0V-3.6V$	0 ns/V to 10 ns/V
Control Input $V_{CC} = 4.5V-5.5V$	0 ns/V to 5 ns/V
Thermal Resistance (θ_{JA})	250°C/W

Note 1: The "Absolute Maximum Ratings" are those values beyond which the safety of the device cannot be guaranteed. The device should not be operated at these limits. The parametric values defined in the Electrical Characteristics tables are not guaranteed at the absolute maximum ratings. The "Recommended Operating Conditions" table will define the conditions for actual device operation.

Note 2: The input and output negative voltage ratings may be exceeded if the input and output diode current ratings are observed.

Note 3: Unused inputs must be held HIGH or LOW. They may not float.

DC Electrical Characteristics

Symbol	Parameter	V_{CC} (V)	$T_A = +25^\circ C$			$T_A = -40^\circ C$ to $+85^\circ C$		Units	Conditions
			Min	Typ	Max	Min	Max		
V_{IH}	HIGH Level Input Voltage	1.65 to 1.95	0.75 V_{CC}			0.75 V_{CC}		V	
		2.3 to 5.5	0.7 V_{CC}			0.7 V_{CC}			
V_{IL}	LOW Level Input Voltage	1.65 to 1.95	0.25 V_{CC}			0.25 V_{CC}		V	
		2.3 to 5.5	0.3 V_{CC}			0.3 V_{CC}			
I_{IN}	Input Leakage Current	0 to 5.5	± 0.1			± 1.0		μA	$0 \leq V_{IN} \leq 5.5V$
I_{OFF}	Switch OFF Leakage Current	1.65 to 5.5	± 0.1			± 1.0		μA	$0 \leq A, B \leq V_{CC}$
R_{ON}	Switch On Resistance (Note 4)	4.5	6.0		10.0	10.0		Ω	$V_I = 0V, I_O = 30$ mA
			7.0		13.5	13.5			$V_I = 2.4V, I_O = -30$ mA
			6.0		10.0	10.0			$V_I = 4.5V, I_O = -30$ mA
			7.5		15.0	15.0			$V_I = 0V, I_O = 24$ mA
		3.0	8.5		15.0	15.0		Ω	$V_I = 3V, I_O = -24$ mA
			9.0		20.0	20.0			$V_I = 0V, I_O = 8$ mA
		2.3	10.5		20.0	20.0		Ω	$V_I = 2.3V, I_O = -8$ mA
			12.5		30.0	30.0			$V_I = 0V, I_O = 4$ mA
1.65	17.0		30.0	30.0		Ω	$V_I = 1.65V, I_O = -4$ mA		
							$V_I = 0V, I_O = 4$ mA		
I_{CC}	Quiescent Supply Current All Channels ON or OFF	5.5	1.0			10.0	μA	$V_{IN} = V_{CC}$ or GND $I_{OUT} = 0$	
	Analog Signal Range	V_{CC}	0	V_{CC}	0	V_{CC}	V		
RRange	On Resistance Over Signal Range (Note 4)(Note 5)	4.5	8.0		15.0	15.0	Ω	$I_O = -30$ mA, $0 \leq V_I \leq V_{CC}$	
		3.0	15.0		30.0	30.0		$I_O = -24$ mA, $0 \leq V_I \leq V_{CC}$	
		2.3	45.0		75.0	75.0		$I_O = -8$ mA, $0 \leq V_I \leq V_{CC}$	
		1.65	150		275	275		$I_O = -4$ mA, $0 \leq V_I \leq V_{CC}$	
ΔR_{ON}	On Resistance Match Between Channels (Note 4)(Note 7)	4.5	0.2				Ω	$I_O = -30$ mA, $V_I = 3.15$	
		3.0	0.2					$I_O = -24$ mA, $V_I = 2.1$	
		2.3	0.5					$I_O = -8$ mA, $V_I = 1.6$	
		1.65	0.6					$I_O = -4$ mA, $V_I = 1.15$	
R_{flat}	On Resistance Flatness (Note 4)(Note 5)(Note 6)	4.5	2.5	6.0	6.0		Ω	$I_O = -30$ mA, $0 \leq V_I \leq V_{CC}$	
		3.0	8.0	17.5	17.5			$I_O = -24$ mA, $0 \leq V_I \leq V_{CC}$	
		2.3	33.0	60.0	60.0			$I_O = -8$ mA, $0 \leq V_I \leq V_{CC}$	
		1.65	135	250	250			$I_O = -4$ mA, $0 \leq V_I \leq V_{CC}$	

Note 4: Measured by the voltage drop between A and B pins at the indicated current through the switch. On Resistance is determined by the lower of the voltages on the two (A or B) pins.

Note 5: Guaranteed by design.

Note 6: Flatness is defined as the difference between the minimum and maximum value of ON Resistance over the specified range of conditions.

DC Electrical Characteristics (Continued)

Note 7: $\Delta R_{ON} = R_{ON\ max} - R_{ON\ min}$ measured at identical V_{CC} , temperature and voltage levels.

AC Electrical Characteristics

Symbol	Parameter	V _{CC} (V)	T _A = -40°C to +85°C			Units	Conditions	Figure Number
			Min	Typ	Max			
t _{PHL} , t _{PLH}	Propagation Delay Bus-to-Bus (Note 8)	4.5 to 5.5		0.35	1.0	ns	V _I = OPEN C _L = 50 pF, R _U = R _D = 500Ω	Figures 1, 2
		3.0 to 3.6		0.7	1.5			
		2.3 to 2.7		1.1	2.5			
		1.65 to 1.95		2.0	4.0			
t _{PZL} , t _{PZH}	Output Enable Time Turn on Time	4.5 to 5.5	0.8	2.0	3.2	ns	V _I = 0V for t _{PZH} V _I = 2 x V _{CC} for t _{PZL} C _L = 50 pF, R _U = R _D = 500Ω	Figures 1, 2
		3.0 to 3.6	1.2	2.5	3.9			
		2.3 to 2.7	1.5	3.2	5.6			
		1.65 to 1.95	2.5	5.7	10.0			
t _{PLZ} , t _{PHZ}	Output Disable Time Turn Off Time	4.5 to 5.5	0.8	2.6	4.1	ns	V _I = 0V for t _{PHZ} V _I = 2 x V _{CC} for t _{PLZ} C _L = 50 pF, R _U = R _D = 500Ω	Figures 1, 2
		3.0 to 3.6	1.5	3.4	5.0			
		2.3 to 2.7	2.0	4.2	6.9			
		1.65 to 1.95	3.0	6.2	10.5			
Q	Charge Injection (Note 9)	1.65 to 5.5				pC	C _L = 0.1 nF, V _{GEN} = 0V, R _{GEN} = 0 Ω, f = 1 MHz	Figure 3
OIRR	Off Isolation (Note 10)	1.65 to 5.5		-55.0		dB	R _L = 50 Ω, C _L = 5 pF, f = 10 MHz	Figure 4
Xtalk	Crosstalk	1.65 to 5.5		-70.0		dB	R _L = 50 Ω, C _L = 5 pF, f = 10 MHz	Figure 5
BW	-3dB Bandwidth	1.65 to 5.5		>300		MHz	R _L = 50 Ω	Figure 8
THD	Total Harmonic Distortion (Note 9)	5		.016		%	R _L = 600Ω 0.5 V _{P-P} f = 600 Hz to 20 KHz	

Note 8: This parameter is guaranteed by design. The switch contributes no propagation delay other than the RC delay of the On Resistance of the switch and the 50 pF load capacitance.

Note 9: Guaranteed by design.

Note 10: Off Isolation = 20 log₁₀ [V_A/V_{Bn}]

Capacitance

Symbol	Parameter	Typ	Max	Units	Conditions	Figures
C _{IN}	Control Pin Input Capacitance	2.5		pF	V _{CC} = 0V	
C _{I/O} (OFF)	Switch Port Off Capacitance	5.0		pF	V _{CC} = 5.0V	Figure 6
C _{I/O} (ON)	Switch Port Capacitance when Switch is Enabled	10.0		pF	V _{CC} = 5.0V	Figure 7

AC Loading and Waveforms

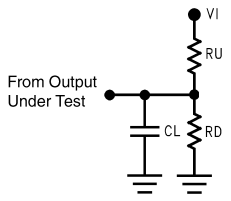

Input driven by 50Ω source terminated in 50Ω
 CL includes load and stray capacitance.
 Input PRR = 1.0 MHz; $t_w = 500$ ns

FIGURE 1. AC Test Circuit

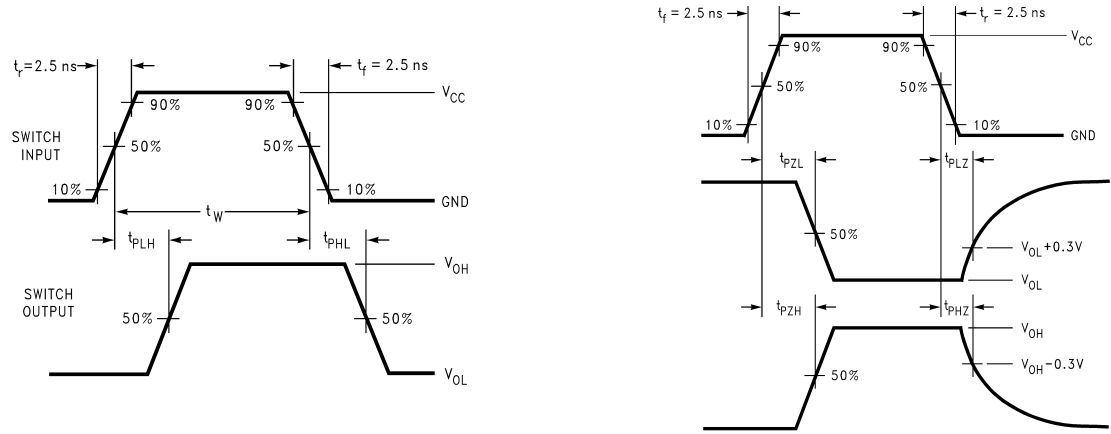

FIGURE 2. AC Waveforms

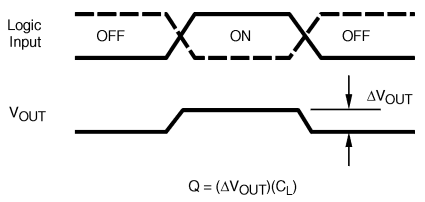
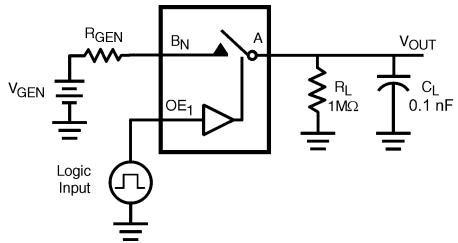

FIGURE 3. Charge Injection Test

AC Loading and Waveforms (Continued)

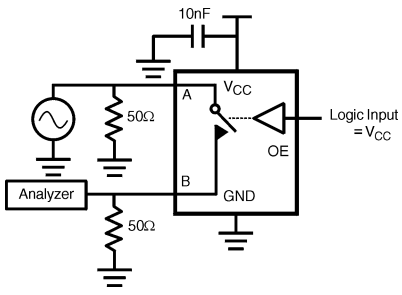

FIGURE 4. Off Isolation

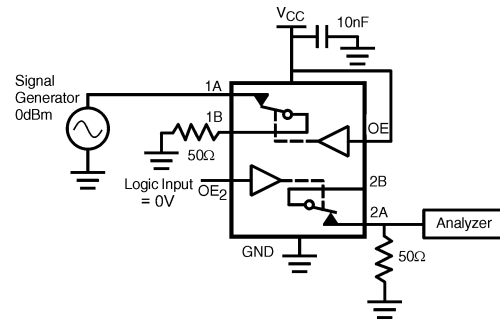

FIGURE 5. Crosstalk

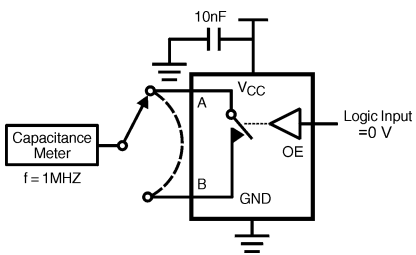

FIGURE 6. Channel Off Capacitance

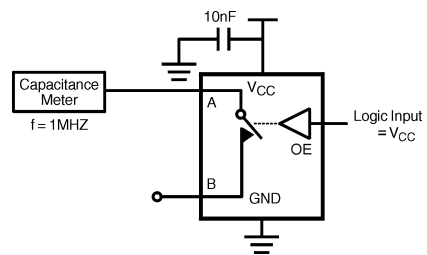

FIGURE 7. Channel On Capacitance

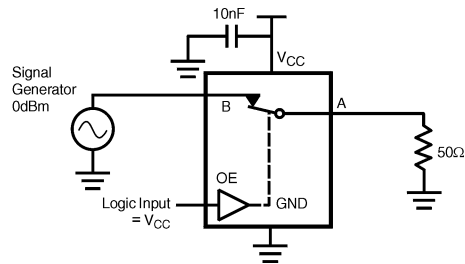

FIGURE 8. Bandwidth

Tape and Reel Specification

TAPE FORMAT for US8

Package Designator	Tape Section	Number Cavities	Cavity Status	Cover Tape Status
K8X	Leader (Start End)	125 (typ)	Empty	Sealed
	Carrier	250	Filled	Sealed
	Trailer (Hub End)	75 (typ)	Empty	Sealed

TAPE DIMENSIONS inches (millimeters)

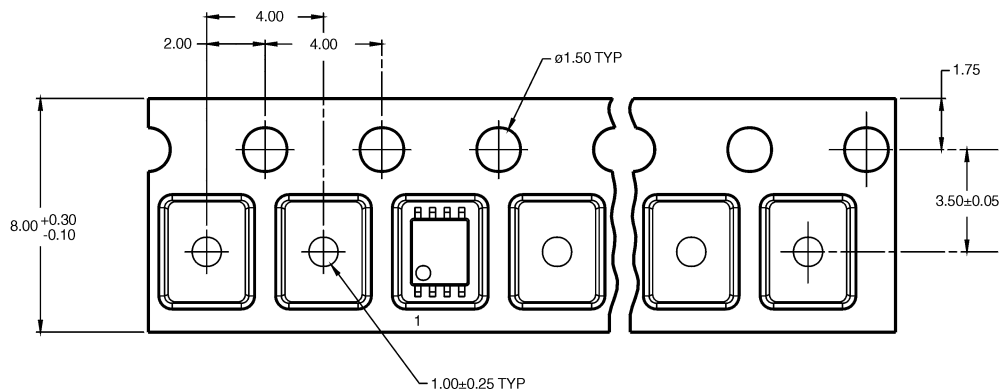

TAPE FORMAT for MicroPak

Package Designator	Tape Section	Number Cavities	Cavity Status	Cover Tape Status
L8X	Leader (Start End)	125 (typ)	Empty	Sealed
	Carrier	250	Filled	Sealed
	Trailer (Hub End)	75 (typ)	Empty	Sealed

TAPE DIMENSIONS inches (millimeters)

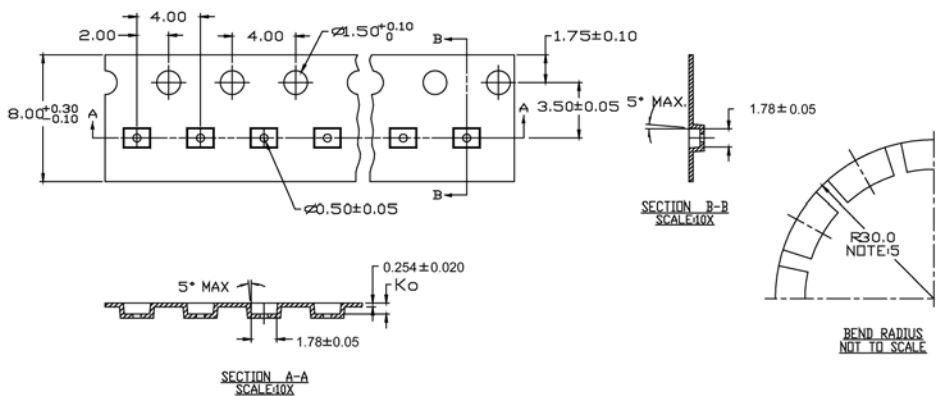

REEL DIMENSIONS inches (millimeters)

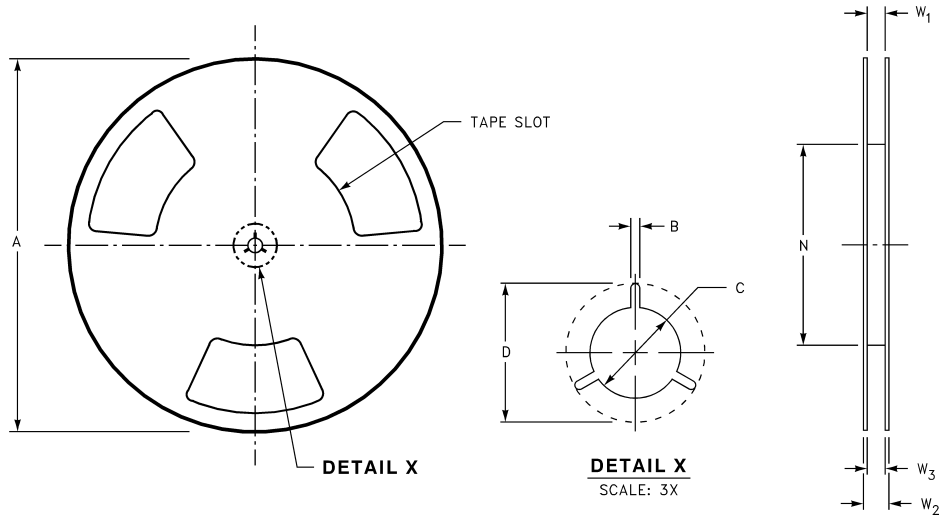

Tape Size	A	B	C	D	N	W1	W2	W3
8 mm	7.0 (177.8)	0.059 (1.50)	0.512 (13.00)	0.795 (20.20)	2.165 (55.00)	0.331 + 0.059/-0.000 (8.40 + 1.50/-0.00)	0.567 (14.40)	W1 + 0.078/-0.039 (W1 + 2.00/-1.00)

Physical Dimensions inches (millimeters) unless otherwise noted

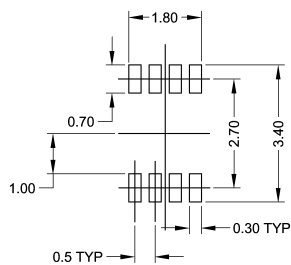
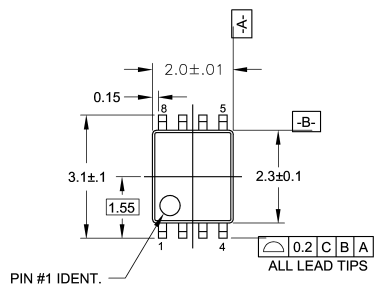

LAND PATTERN RECOMMENDATION

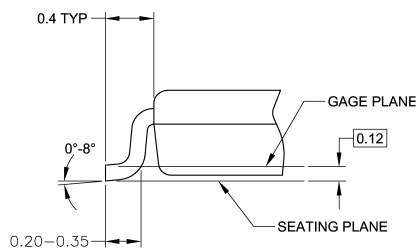
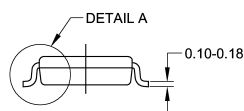
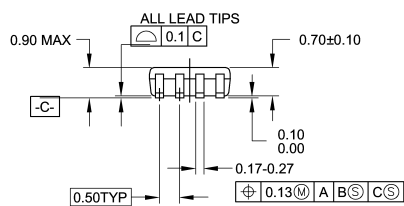

DETAIL A

NOTES:

- A. CONFORMS TO JEDEC REGISTRATION MO-187
- B. DIMENSIONS ARE IN MILLIMETERS.
- C. DIMENSIONS ARE EXCLUSIVE OF BURRS, MOLD FLASH, AND TIE BAR EXTRUSIONS.
- D. DIMENSIONS AND TOLERANCES PER ANSI Y14.5M, 1982.

MAB08AREVC

**8-Lead US8, JEDEC MO-187, Variation CA 3.1mm Wide
Package Number MAB08A**

Physical Dimensions inches (millimeters) unless otherwise noted (Continued)

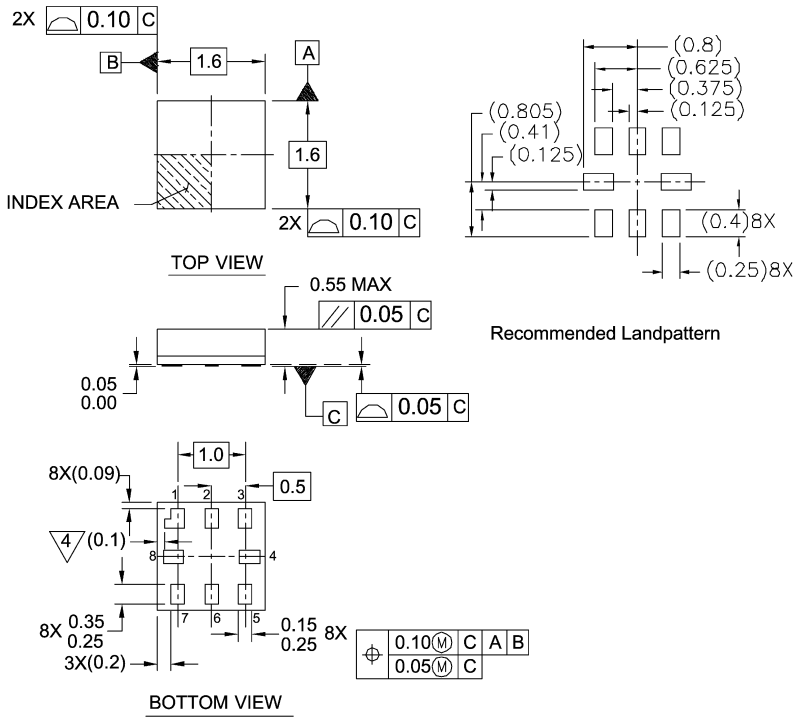

Notes:

1. PACKAGE CONFORMS TO JEDEC MO-255 VARIATION UAAD
2. DIMENSIONS ARE IN MILLIMETERS
3. DRAWING CONFORMS TO ASME Y.14M-1994
4. PIN 1 FLAG, END OF PACKAGE OFFSET.

MAC08AREVC

**Pb-Free 8-Lead MicroPak, 1.6 mm Wide
Package Number MAC08A**

DISCLAIMER

FAIRCHILD SEMICONDUCTOR RESERVES THE RIGHT TO MAKE CHANGES WITHOUT FURTHER NOTICE TO ANY PRODUCTS HEREIN TO IMPROVE RELIABILITY, FUNCTION OR DESIGN. FAIRCHILD DOES NOT ASSUME ANY LIABILITY ARISING OUT OF THE APPLICATION OR USE OF ANY PRODUCT OR CIRCUIT DESCRIBED HEREIN; NEITHER DOES IT CONVEY ANY LICENSE UNDER ITS PATENT RIGHTS, NOR THE RIGHTS OF OTHERS.

LIFE SUPPORT POLICY

FAIRCHILD'S PRODUCTS ARE NOT AUTHORIZED FOR USE AS CRITICAL COMPONENTS IN LIFE SUPPORT DEVICES OR SYSTEMS WITHOUT THE EXPRESS WRITTEN APPROVAL OF FAIRCHILD SEMICONDUCTOR CORPORATION

As used herein:

1. Life support devices or systems are devices or systems which, (a) are intended for surgical implant into the body, or (b) support or sustain life, or (c) whose failure to perform when properly used in accordance with instructions for use

provided in the labeling, can be reasonably expected to result in significant injury to the user.

2. A critical component is any component of a life support device or system whose failure to perform can be reasonably expected to cause the failure of the life support device or system, or to affect its safety or effectiveness.

PRODUCT STATUS DEFINITIONS

Definition of terms

Datasheet Identification	Product Status	Definition
Advance Information	Formative or In Design	This datasheet contains the design specifications for product development. Specifications may change in any manner without notice.
Preliminary	First Production	This datasheet contains preliminary data, and supplementary data will be published at a later date. Fairchild Semiconductor reserves the right to make changes at any time without notice in order to improve design.
No Identification Needed	Full Production	This datasheet contains final specifications. Fairchild Semiconductor reserves the right to make changes at any time without notice in order to improve design.
Obsolete	Not In Production	This datasheet contains specifications on a product that has been discontinued by Fairchild Semiconductor. The datasheet is printed for reference information only.