

FX-4400

High Output Xenon Flashlamp



Preliminary Data

Description

The new FX-4400 Light Source from PerkinElmer Optoelectronics is a compact, high-output, long-life pulsed xenon flashlamp that offers exceptional arc stability, microsecond pulse durations and a high-intensity continuous line spectrum from the deep UV to the far IR.

The lamp utilizes an integral parabolic reflector to provide a collimated output beam and is capable of operating at up to 60 Watts average power. This new design measures approximately the same size as our traditional pulsed xenon lamps, yet provides up to 20X the light output intensity. This allows customers the option of either taking advantage of the greatly increased light output or operating the FX-4400 at a reduced input energy for increased lamp life and stability.

Lamp life exceeds 1 billion flashes, when operating at an input energy of up to 0.5 Joules per flash. The maximum flash rate is 1 kHz for an input energy of 60 milliJoules.

Several window materials are available to provide customers with transmission output ranging from 160nm to 20 microns.

PerkinElmer will work closely with OEM's to customize the light source and related electronics to meet the most demanding applications.

Also, our broad technical expertise in light sources, optics, detectors, light management and signal processing allows us to work with and provide OEM's with unique Sensor solutions that generate, control and measure light.

Features

- Up to 20x the output intensity of traditional xenon style lamps
- Exceptional arc stability
- Long Life
- Continuous spectrum UV-VIS-IR
- Collimated Output beam
- Ideal for use with Optical Lenses and Fiber Bundles
- Low optical noise
- Microsecond flash durations
- Various window materials (transmissions ranging from 160nm to 20 microns)
- High repetition flash rates
- No Warm-up period required
- Compact size



FX-4400 High Output Xenon Flashlamp

Electrical Specifications (all lamps)

Lamp Type	Spectral Distribution	Window Material
FX-4400	275 - 2000+	Borosilicate
FX-4401	190 - 2000+	UV Glass
FX-4402	160 - 4000	Sapphire
FX-4403	600 - 20,000	ZnSe

Notes:

1) Input Energy or $E = \frac{1}{2}CV^2$ where E = Discharge Energy (Joules)
 C = Discharge Capacitor Value
 V = Discharge Voltage

The lamp is capable of an input energy higher than 1.0 J/Flash but long life can not be guaranteed.

2) Maximum Average Power or $P_{AVE} = EF$ where

P_{AVE} = Average Power (Watts)

E = Discharge Energy

F = Rate of flashes in pulses per second

Additional cooling required when operating above 40 Watts.

3) Flash rate must be set so as not to exceed 60-Watts Average Power. (See Note 2) To operate the lamp at greater than 1000Hz consult with a PerkinElmer Product Specialist.

4) Life is primarily a function of input energy per flash ($E = \frac{1}{2}CV^2$) but is also influenced by average power and peak current. See curves on this page for typical lamp performance.

5) Typical for most operating conditions. Lamp output stability is dependent on a number of variables including input energy, flash rate, optics design, Lite Pac and Power Supply.

Electrical Specifications (all lamps)

Energy per flash (joules) ¹	1.0 Max
Average Power (Watts) ²	60
Voltage (Volts)	400 - 1000
Flash Rate (Hz) ³	1000
Life (flashes) ⁴	> 1 x 10 ⁹
Output Stability ⁵	< 3%
Lite Pac	FYD-4400
Power Supply	PS4400

Physical Dimensions

Arc Gap	0.060 inch (1.5mm)
Reflector Geometry	Parabolic Y2 = 0.5X inches
Weight	125 Grams
Window Diameter	1.0 Inch (25.4mm)

Outline Drawing

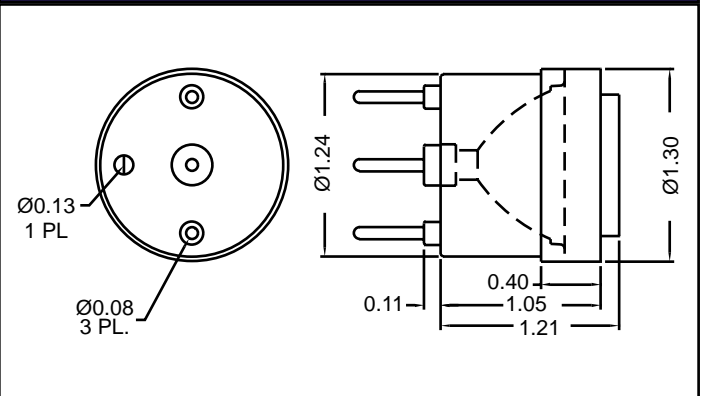

Output Beam Angle

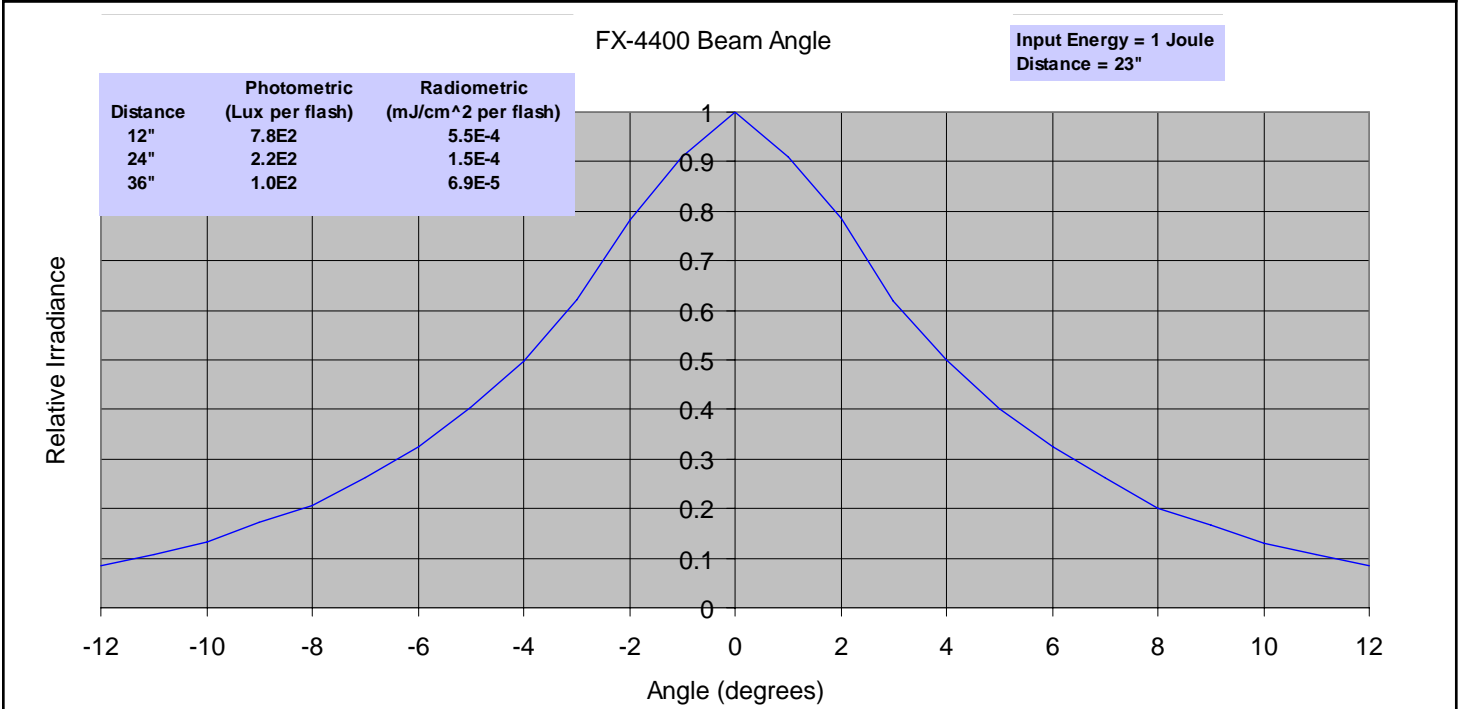

Lamp Life

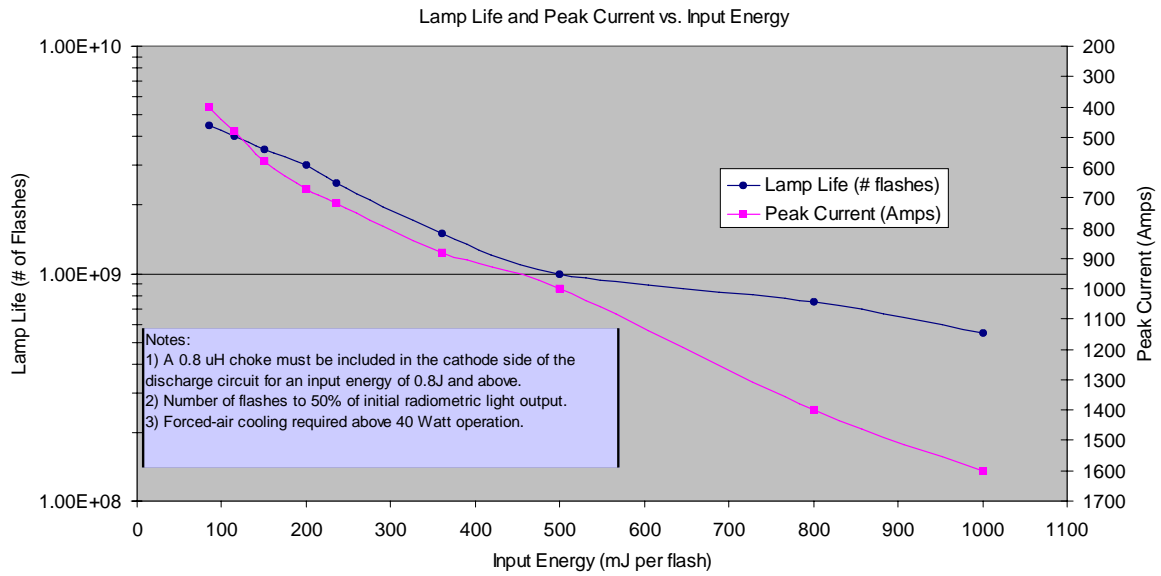

Spectral Output

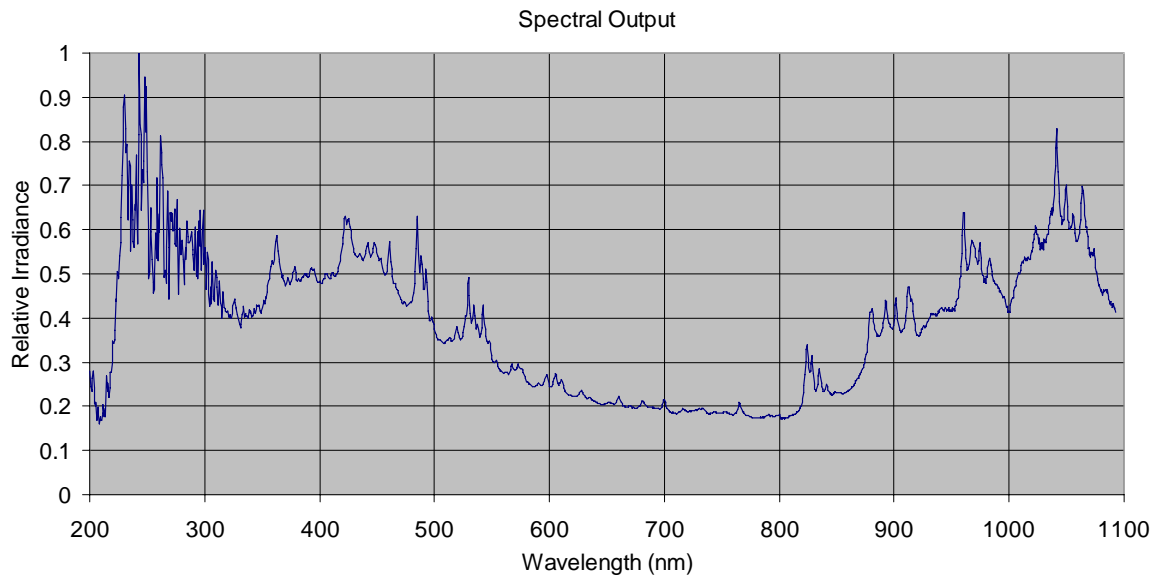

Pulse Width

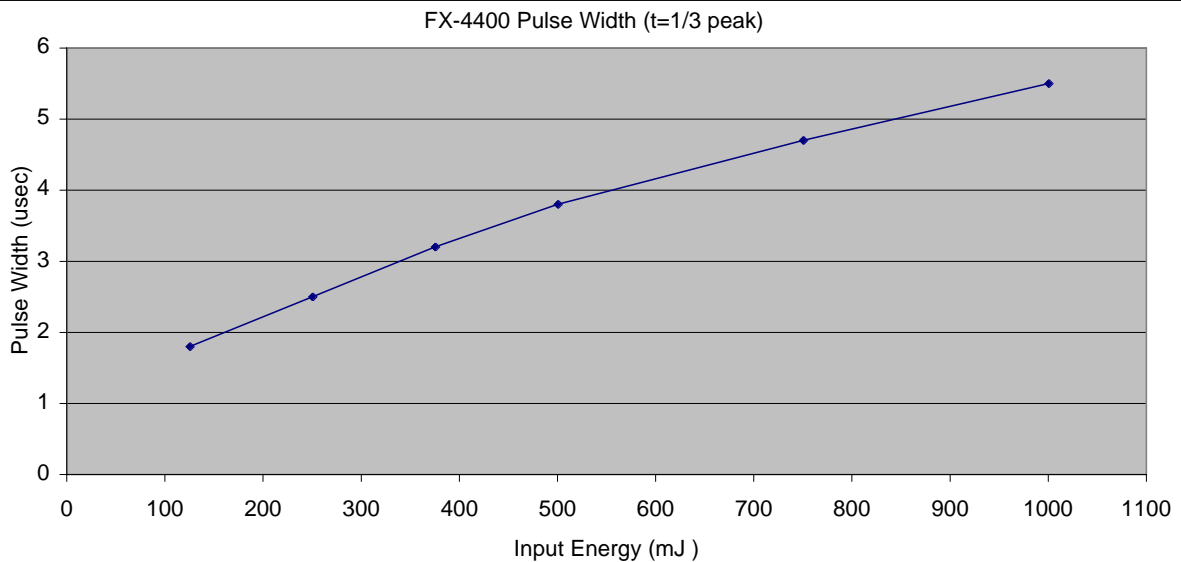

FYD--4400 Outline and Inputs

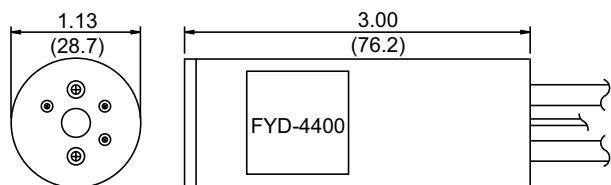

Trigger input: 0.22µf @ 175±15%
 Discharge energy: 1.0 Joules Max.
 Average power: 60 Watts (1)
 Lead length: 12 inches (30.5)

1) Additional cooling required when operated above 40 watts.

PS-4400 Inputs

Voltage	24 VDC ± 10%
DC Current	3A @ 24 VDC
Peak Current	5.2A @ 24 VDC
Trigger	(1)
Opto Isolated Trigger	Yes
Vref (Vo/Vref=226)	1.77 - 4.42 VDC
EMI Suppression	(2)

PS-4400 Output

Discharge	
Voltage (Vo)	400-1000 VDC ±2%
Power	60 watts
Internal Discharge Capacitor	0.47µf (3)
Trigger	
Trigger Voltage	175 VDC ± 15
Trigger Capacitor	0.22 µf
Trigger rate	1000 Hz Max

Notes: 1) 20 to 50 ma peak input; 10 to 100 µsec pulse width; leading edge trigger, internal series resistor 150 Ohms.
 2) Inductor and filter capacitor for power input. All inputs through shielded connector.
 3) Standard value is 0.47 µf, 0.1, 0.22, 0.33, 0.94, and 1.88 µf also available.

Mechanical Specifications

Weight	24 oz (680 g)
Input Connector	9 Pin "D"
Output Connector	Screw clamp terminal strip
Enclosure	Metal

Environmental Specifications

Operating Temperature	32 to 104°F (0 to 40°C)
Storage Temperature	-40 to 194°F (-40 to +90°C)

PS-4400 Outline Drawing

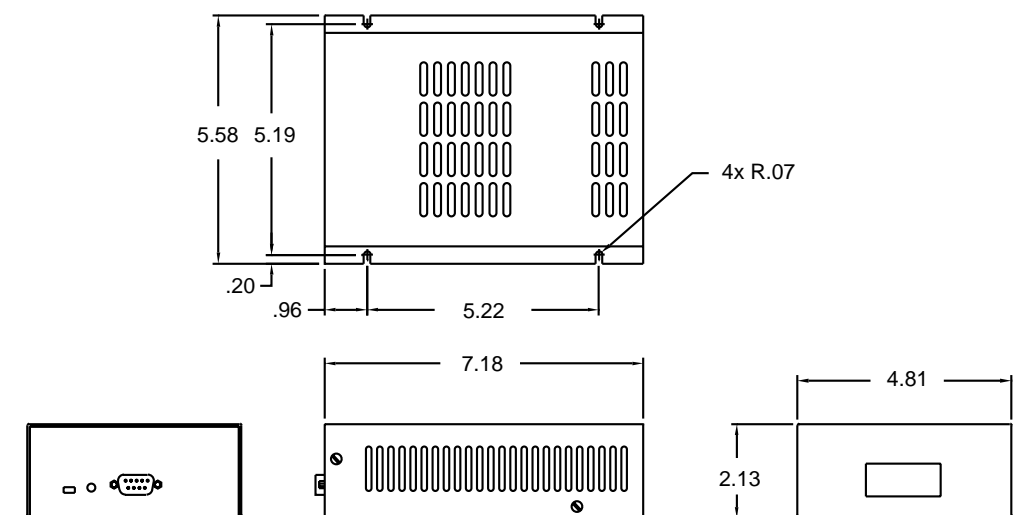

USA:
 PerkinElmer Optoelectronics
 35 Congress Street
 Salem, MA 01970
 Toll Free: (800) 950-3441 (USA)
 Phone: (978) 745-3200
 Fax: (978) 745-0894

Europe:
 PerkinElmer Optoelectronics
 Wenzel-Jaksch-Str. 31, D-65199
 Weisbaden, Germany
 Phone: +49 (0) 611-492-437
 Fax: +49 (0)611-492-159

Asia:
 PerkinElmer Optoelectronics
 47 Ayer Rajah Crescent #06-12
 Singapore 139947
 Phone: +65 775 2022
 Fax: +65 775 1008

