

**PRELIMINARY**  
 Notice: This is not a final specification.  
 Some parametric limits are subject to change.

MITSUBISHI Pch POWER MOSFET

# FX20ASJ-03

HIGH-SPEED SWITCHING USE

**FX20ASJ-03**



- 4V DRIVE
- $V_{DSS}$  ..... -30V
- $r_{DS(ON)}$  (MAX) .....  $0.13\Omega$
- $I_D$  ..... -20A
- Integrated Fast Recovery Diode (TYP.) ..... 50ns

**OUTLINE DRAWING** Dimensions in mm

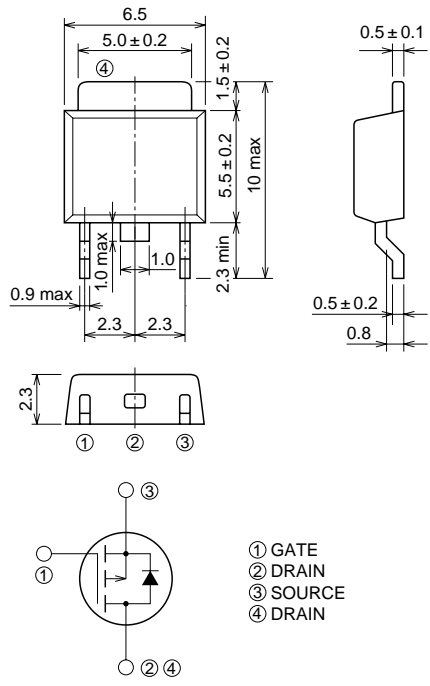

① GATE  
 ② DRAIN  
 ③ SOURCE  
 ④ DRAIN

**MP-3**

## APPLICATION

Motor control, Lamp control, Solenoid control  
 DC-DC converter, etc.

## MAXIMUM RATINGS (Tc = 25°C)

Symbol	Parameter	Conditions	Ratings	Unit
$V_{DSS}$	Drain-source voltage	$V_{GS} = 0V$	-30	V
$V_{GSS}$	Gate-source voltage	$V_{DS} = 0V$	$\pm 20$	V
$I_D$	Drain current		-20	A
$I_{DM}$	Drain current (Pulsed)		-80	A
$I_{DA}$	Avalanche drain current (Pulsed)	$L = 10\mu H$	-20	A
$I_S$	Source current		-20	A
$I_{SM}$	Source current (Pulsed)		-80	A
$P_D$	Maximum power dissipation		30	W
$T_{ch}$	Channel temperature		-55 ~ +150	°C
$T_{stg}$	Storage temperature		-55 ~ +150	°C
—	Weight	Typical value	0.26	g

**PRELIMINARY**  
 Notice: This is not a final specification.  
 Some parametric limits are subject to change.

**ELECTRICAL CHARACTERISTICS** (Tch = 25°C)

Symbol	Parameter	Test conditions	Limits			Unit
			Min.	Typ.	Max.	
V (BR) DSS	Drain-source breakdown voltage	Id = -1mA, VDs = 0V	-30	—	—	V
IGSS	Gate-source leakage current	VGS = ±20V, VDS = 0V	—	—	±0.1	μA
IDSS	Drain-source leakage current	VDS = -30V, VGS = 0V	—	—	-0.1	mA
VGS (th)	Gate-source threshold voltage	Id = -1mA, VDS = -10V	-1.3	-1.8	-2.3	V
rDS (ON)	Drain-source on-state resistance	Id = -10A, VGS = -10V	—	0.11	0.13	Ω
rDS (ON)	Drain-source on-state resistance	Id = -2A, VGS = -4V	—	0.21	0.29	Ω
VDS (ON)	Drain-source on-state voltage	Id = -10A, VGS = -10V	—	-1.1	-1.3	V
yfs	Forward transfer admittance	Id = -10A, VDS = -5V	—	5.8	—	S
Ciss	Input capacitance	VDS = -10V, VGS = 0V, f = 1MHz	—	1130	—	pF
Coss	Output capacitance		—	232	—	pF
Crss	Reverse transfer capacitance		—	83	—	pF
td (on)	Turn-on delay time		—	15	—	ns
tr	Rise time	VDD = -15V, Id = -10A, VGS = -10V, RGEN = RGS = 50Ω	—	33	—	ns
td (off)	Turn-off delay time		—	49	—	ns
tf	Fall time		—	26	—	ns
VSD	Source-drain voltage		IS = -10A, VGS = 0V	—	-1.0	-1.5
Rth (ch-c)	Thermal resistance	Channel to case	—	—	4.17	°C/W
trr	Reverse recovery time	IS = -10A, dis/dt = 50A/μs	—	50	—	ns

**PERFORMANCE CURVES**

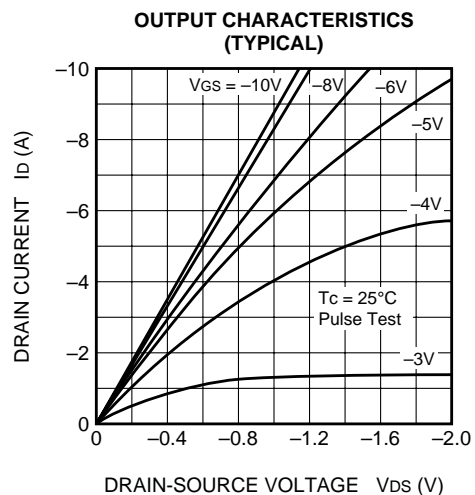
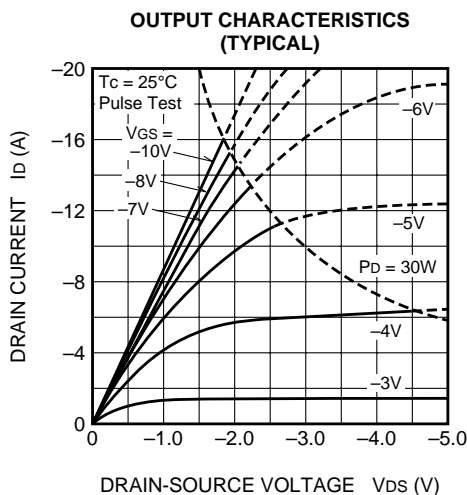
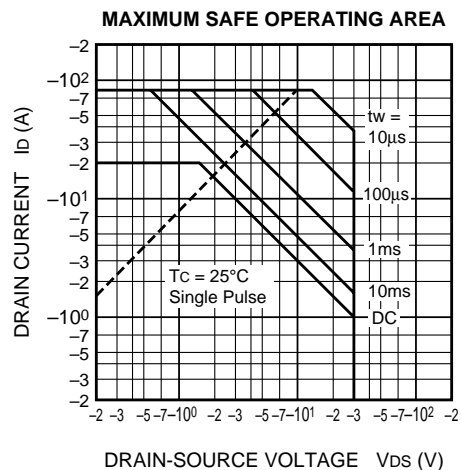
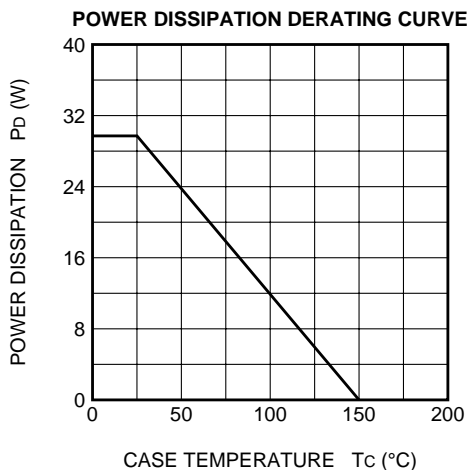

**PRELIMINARY**  
 Notice: This is not a final specification.  
 Some parametric limits are subject to change.

**ON-STATE VOLTAGE VS. GATE-SOURCE VOLTAGE (TYPICAL)**

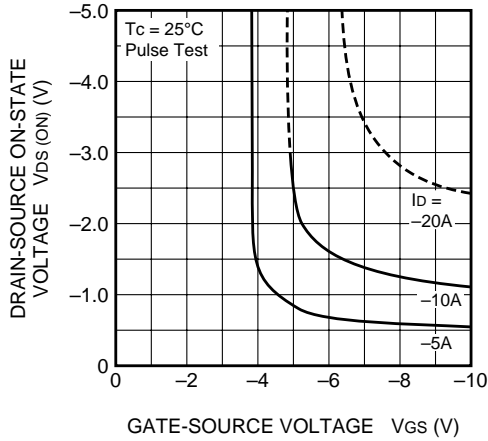

**ON-STATE RESISTANCE VS. DRAIN CURRENT (TYPICAL)**

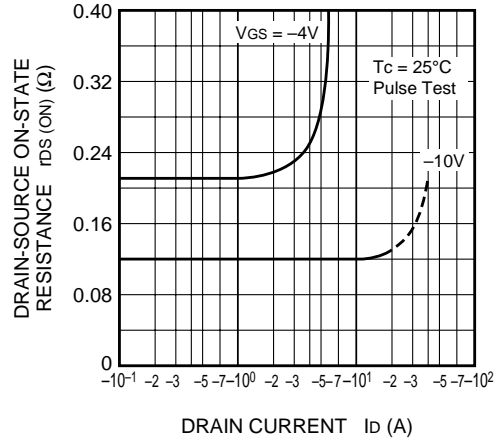

**TRANSFER CHARACTERISTICS (TYPICAL)**

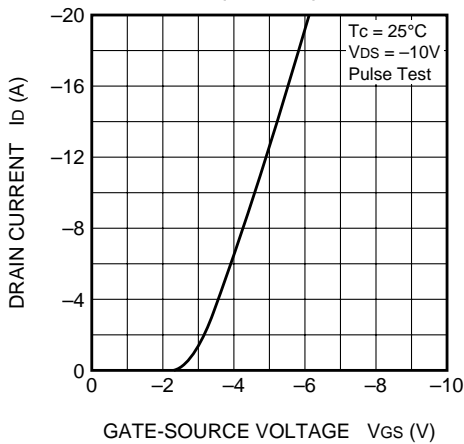

**FORWARD TRANSFER ADMITTANCE VS. DRAIN CURRENT (TYPICAL)**

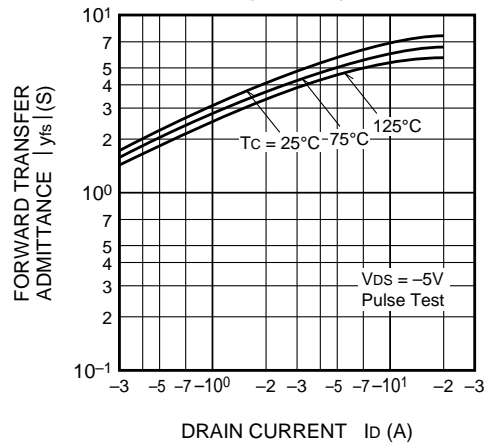

**CAPACITANCE VS. DRAIN-SOURCE VOLTAGE (TYPICAL)**

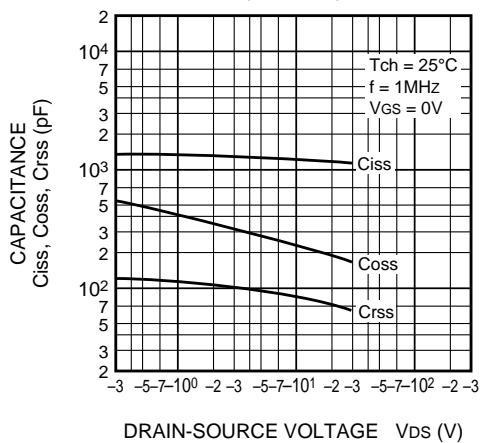

**SWITCHING CHARACTERISTICS (TYPICAL)**

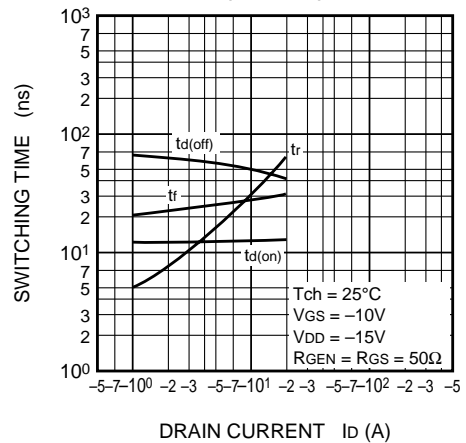

**PRELIMINARY**  
 Notice: This is not a final specification.  
 Some parametric limits are subject to change.

**GATE-SOURCE VOLTAGE VS. GATE CHARGE (TYPICAL)**

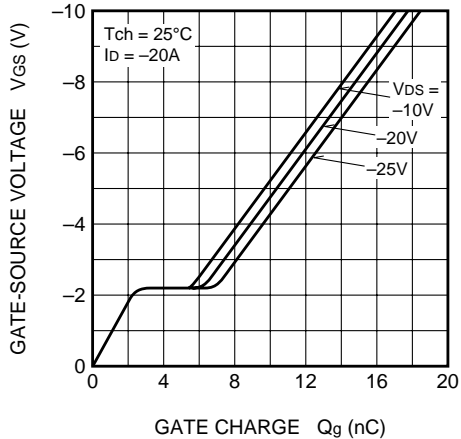

**SOURCE-DRAIN DIODE FORWARD CHARACTERISTICS (TYPICAL)**

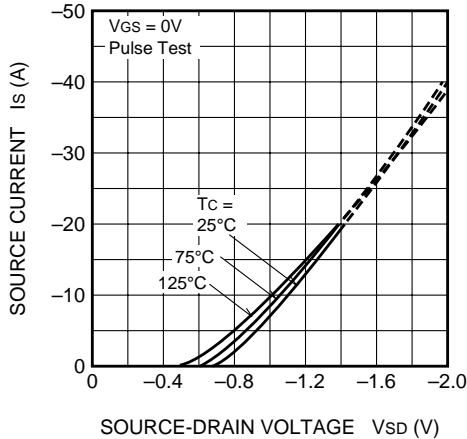

**ON-STATE RESISTANCE VS. CHANNEL TEMPERATURE (TYPICAL)**

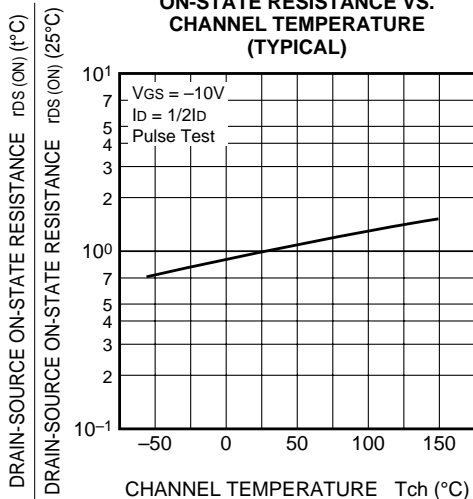

**THRESHOLD VOLTAGE VS. CHANNEL TEMPERATURE (TYPICAL)**

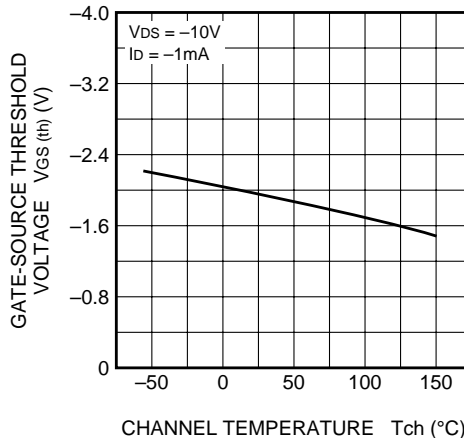

**BREAKDOWN VOLTAGE VS. CHANNEL TEMPERATURE (TYPICAL)**

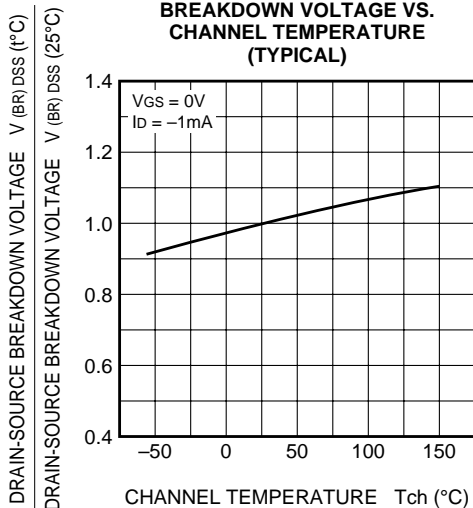

**TRANSIENT THERMAL IMPEDANCE CHARACTERISTICS**

