

Low Profile 3mm DC/DC Buck Converter 0.8V to 4.5V*, 3A with 380W/in³ Power Density Efficiency up to 95%

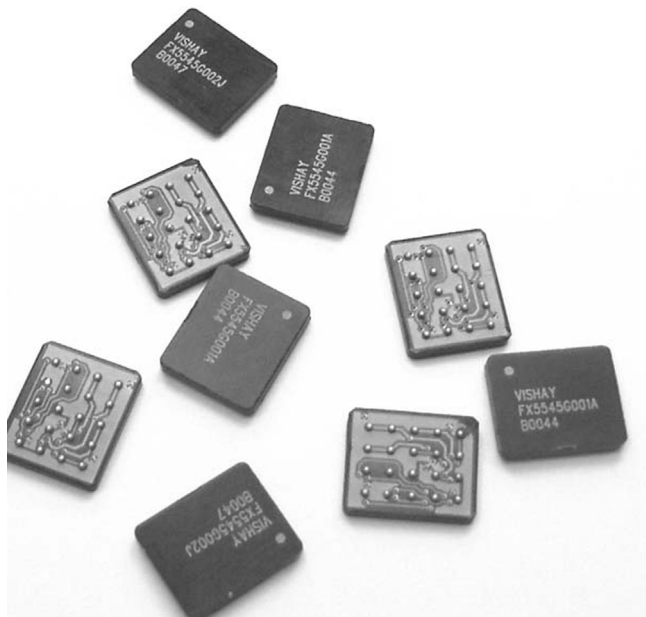

FEATURES

- Fully integrated DC/DC converter
- Advanced development of FX5545G305
- High efficiency over large load range
- 100% duty cycle
- Power density - more than 380W/inch³
- 1µA shutdown current
- 2.5V to 6V input range (1Li+ and 3-cell NiCd or NiMH cells)
- 0.8V to 4.5V* output voltage
- Programmable PWM/PSM controls
- Low output ripple
- BGA construction
- Temperature range: - 40°C to + 85°C
- No external components required
- Output power 10W
- Maximum current 3A
- Low profile

*Note: For higher putput voltage please consult factory at FunctionPAK@Vishay.com

The DC/DC converter is a programmable topology synchronized Buck converter for today's continuous changing portable electronic market. The DC/DC converter provides flexibility of utilizing various battery configurations and chemistries such as NiCd, NiMH, or Li+ with an input voltage range of 2.5V to 6V. An additional flexibility is provided with topology programmability to power multiple loads such as power amplifiers, microcontrollers, or baseband logic IC's. For ultra-high efficiency, converters are designed to operate in synchronous rectified PWM mode under full load while transforming into externally controlled pulse-skipping mode (PSM) under light load.

The DC/DC converter is available in 20-ports BGA package. In order to satisfy the stringent ambient temperature requirements, the DC/DC converter is designed to handle the industrial temperature range of - 40°C to + 85°C.

APPLICATION

- Cordless phones, PDAs and others
- Supply voltage source for low-voltage chip sets
- Point of Load (POL) applications such as drivers for FPGA's, microprocessors, DSP's amplifiers, etc.
- Portable computers
- Battery back-up supplies
- Cameras

ORDERING INFORMATION

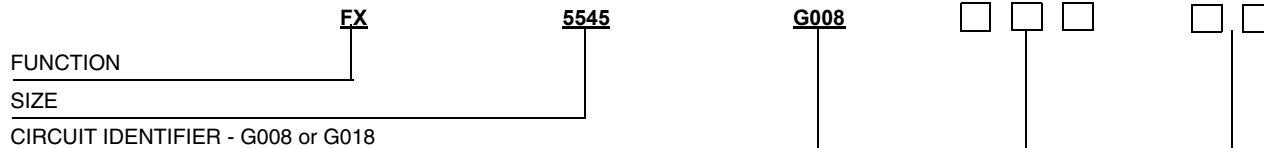

OUTPUT VOLTAGE - Example: 1.2V should be written as 1V2 as the V indicates the decimal point or ADJ for adjustable version - self selectable output voltage. G018ADJ is only available in the adjustable version for Vout = 0.9V - 1.3V. For design considerations please see ANF110

PACKAGING - B1 = 10pcs in bulk; B5 = 50pcs in bulk; T1 = 13" reel; T2 = 7" reel.

DIMENSIONS in inches [millimeters]	
L	0.58 ± 0.01 [14.7 ± 0.25]
W	0.48 ± 0.01 [12.2 ± 0.25]
A	0.1 ± 0.01 [2.54 ± 0.25]
B	0.09 ± 0.01 [2.29 ± 0.25]
C	0.09 ± 0.01 [2.27 ± 0.25]
T	0.126 max [3.2 max]
Ball Diameter	0.03 ± 0.001 [0.762 ± 0.025]

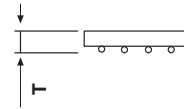
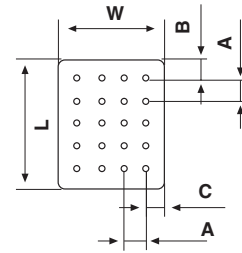
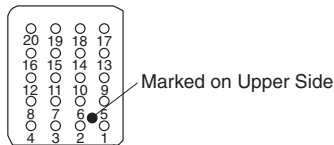
BOTTOM SIDE

*Note: Pin Description application note is available at www.vishay.com/doc?10119

For adjustable version please refer to Self Selectable Output Voltage application note which is available at www.vishay.com/doc?10116

**Note: if not used must be connected to V_{in} .

***Note: N/C - If the output voltage is 0.9V and higher. For output voltage of 0.8V connect V_{ref} to MCL4448 (Vishay RF PIN Diode).

PIN CONFIGURATION*	
PIN	CONNECTION
1, 2	\overline{SD}
3, 7	SYNC**
4, 8	V_{ref} ***
5, 9	V_{in}
6, 10	PWM/PSM
11, 12	N/C
13, 17	GND
14, 18	V_{out}
15, 19	N/C
16, 20	GND

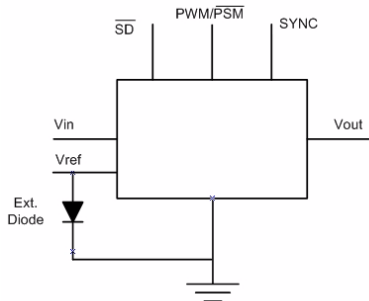
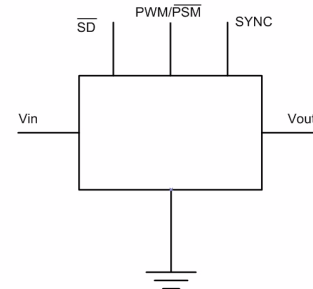
 Pin Configuration for $V_o = 0.8V$

 Pin Configuration for $V_o = 0.9V - 4.5V$

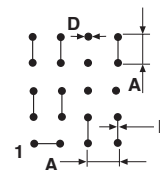
RECOMMENDED PAD PATTERN in inches [millimeters]		
A	D	F
0.1 ± 0.01 [2.54 ± 0.25]	0.03 ± 0.001 [0.8 ± 0.02]	0.02 ± 0.001 [0.5 ± 0.02]



TAPE AND REEL

See Tape and Reel Information - Type B

STANDARD ELECTRICAL SPECIFICATIONS					
PARAMETER	UNIT	CONDITION	MIN	TYP	MAX
Input					
Voltage Range	V_{DC}		2.5		6
Quiescent Current	μA	\overline{PSM} mode		200	
Soft Start Time	ms	T_{SS} for $V_{out} = 3.3V$ T_{SS} for $V_{out} = 1.2V$		4 2.6	
SD, PWM/PSM, SYNC					
Logic High	V	V_H	2.4		
Logic Low	V	V_L			0.8
Normal Mode	μA	I_{DD}			750
\overline{PSM} Mode	μA	I_{DD}			250
Shutdown Mode	μA	I_{DD}			1
Shutdown Time	ms	T_{SS} for $V_{out} = 3.3V$ T_{SS} for $V_{out} = 1.2V$		4 0.6	
Insulation					
Test Voltage	V_{AC}	60Hz 60sec	750		
Resistance	Ω	$V_{ISO} = 500 V_{DC}$	1×10^{11}		
Leakage Current	nA	$V_{ISO} = 500 V_{DC}$			5
Output					
Power	W			10	
Voltage	V_{DC}			0.8 to 4.5	
Voltage Tolerance	%	For $V_{out} = 0.9V$ and above (using external diode BAR065V for $V_{out} = 0.9V$ up to 1.3V) at 25°C Ambient Temp.	- 3		+3
	%	For $V_{out} = 0.8V$ up to 1.3V using external diode MCL4448 at 25°C Ambient Temp.	- 5		+5
Temp. Coefficient	%/°C				0.15
Ripple and Noise	mVpp	DC to 20 MHz		80	
General					
Package Weight	gr.				1.4
Oscillator					
Frequency	KHz			400	
SYNC Range		F_{SYNC}/F_{OSC}	1.2		1.5
Temperature					
Operation	°C		- 40		+ 85
Storage	°C		- 55		+ 125
Operating Junction Temp.	°C	T_j		150	
Thermal Impedance	°C/ W_D *	θ_{JA}		82	

*Note: W_D = Power Dissipated

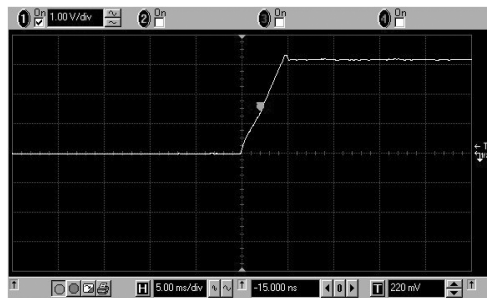
Rise Time



Rise Time (PWM mode): $V_{in} = 6V$; $V_{out} = 3.3V$; $I_{out} = 3A$

Fall Time

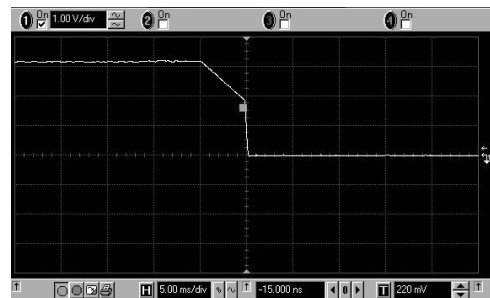

Fall Time (PWM mode): $V_{in} = 6V$; $V_{out} = 3.3V$; $I_{out} = 3A$

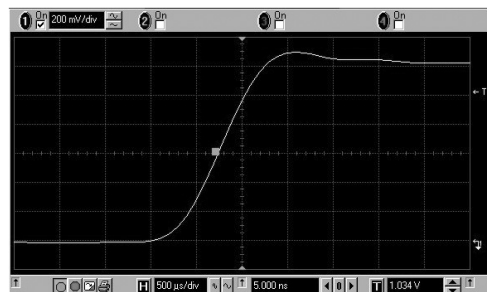

Rise Time (PWM mode): $V_{in} = 6V$; $V_{out} = 1.2V$; $I_{out} = 3A$

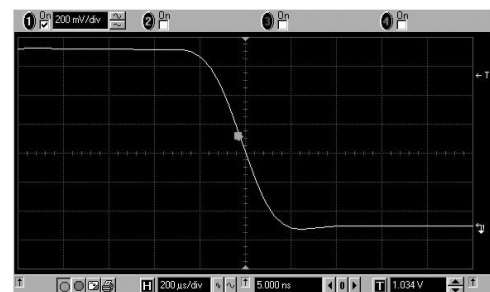

Fall Time (PWM mode): $V_{in} = 6V$; $V_{out} = 1.2V$; $I_{out} = 3A$

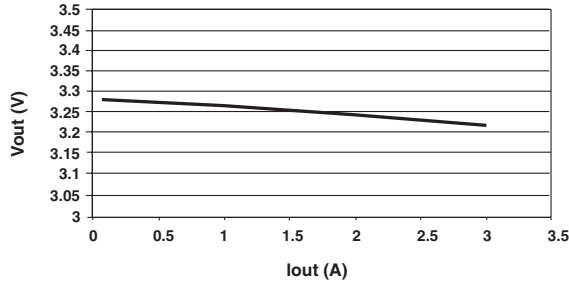
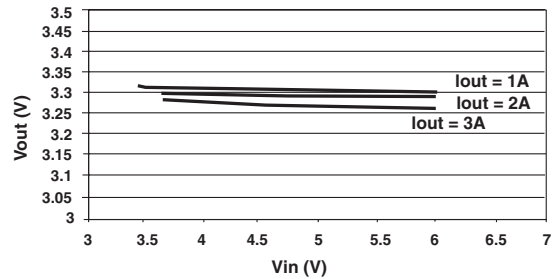
PWM MODE
Vout Vs. Iout*
 Vin = 4.0V

Vout Vs. Vin*

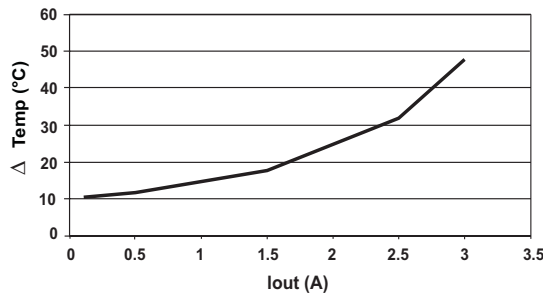
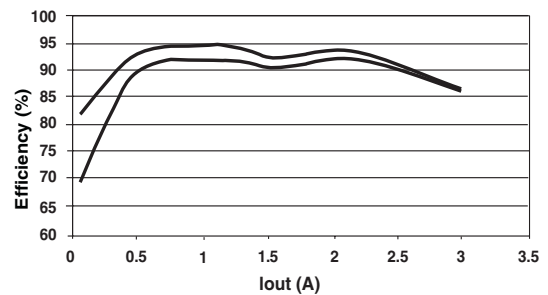
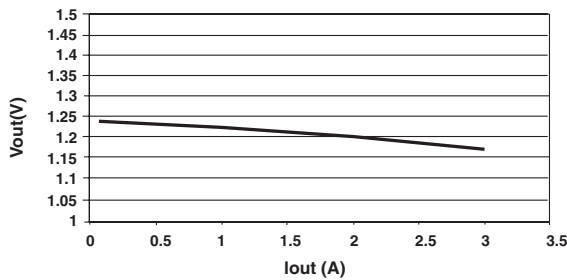
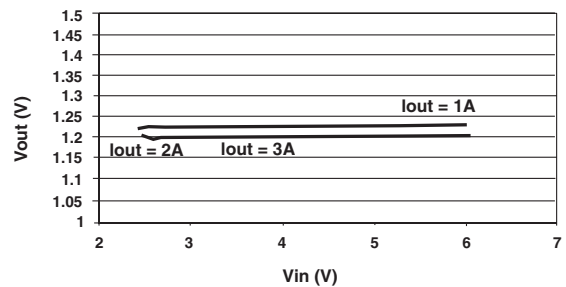
 Δ Temp Vs. Iout*

Above 25°C Ambient Temperature Vin = 6.0V; Vout = 3.3V

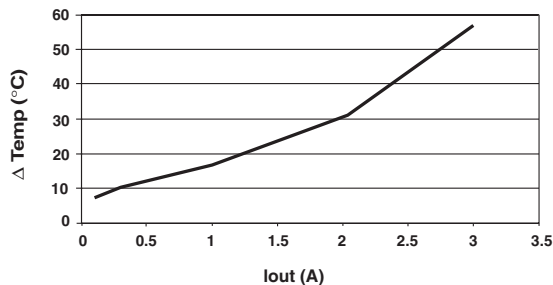
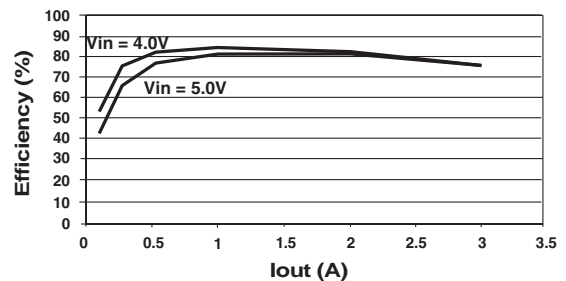
Efficiency Vs. Iout*
 Vout = 3.3A

Vout Vs. Iout*
 Vin = 4.0V

Vout Vs. Vin*
 Vin = 6V

 Δ Temp Vs. Iout*

Above 25°C Ambient Temperature Vin = 6.0V; Vout = 1.2V

Efficiency Vs. Iout*
 Vin = 4.0V; Vout = 1.2V

* Note: Measurements were taken with Power supply: ZUP 20-40 from Nemic Lambda; Electronic load: 6063B from Agilent; Multimeter Fluke 45 from Fluke and 34401 digital multimeter from Agilent; Scope: Infiniium 54815A from Agilent

PSM MODE

Vout Vs. Iout*
Vin = 4.0V

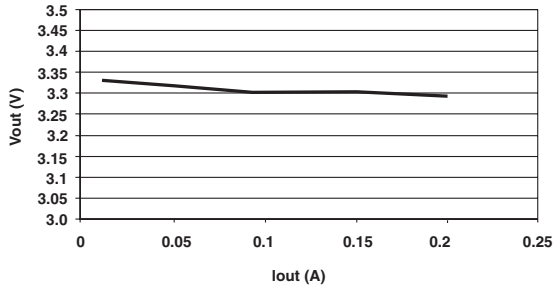

Vout Vs. Vin*
Vin = 6V

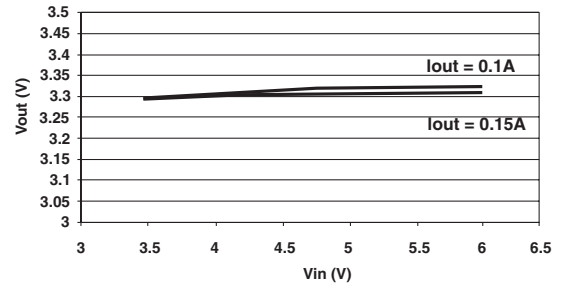

Efficiency Vs. Iout*
Vin = 4.0V; Vout = 3.3V

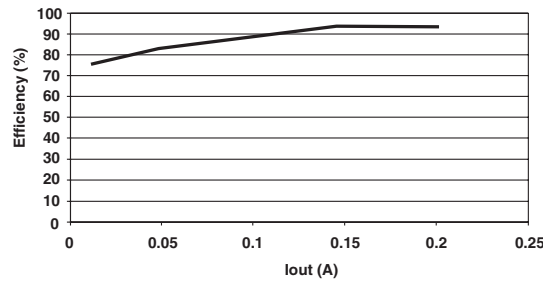

Vout Vs. Iout*
Vin = 4.0V

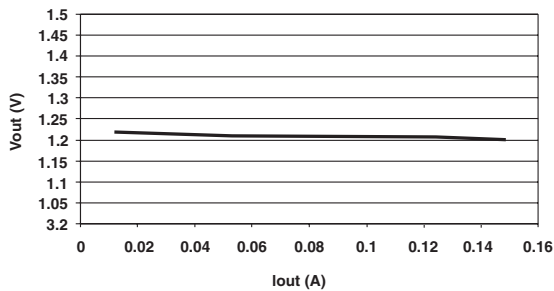

Vout Vs. Vin*

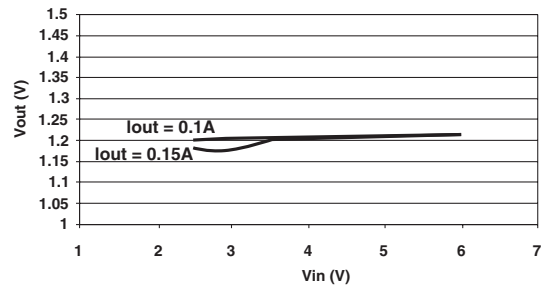

Efficiency Vs. Iout*
Vin = 4.0V; Vout = 1.2V

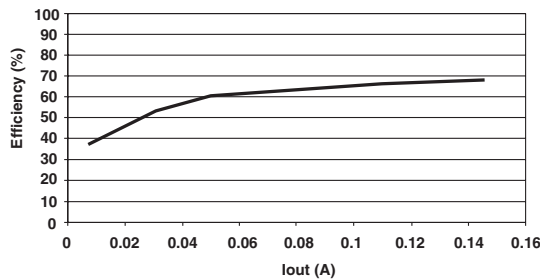

* Note: Measurements were taken with Power supply: ZUP 20-40 from Nemic Lambda; Electronic load: 6063B from Agilent; Multimeter Fluke 45 from Fluke and 34401 digital multimeter from Agilent; Scope: Infiniium 54815A from Agilent