

Relays with Forcibly Guided Contacts

G7SA

Slim Relays with Forcibly Guided Contacts Conforming to EN Standards

- EN50205 Class A, approved by VDE.
- Ideal for use in safety circuits in production machinery.
- Four-pole and six-pole Relays are available.
- The Relay's terminal arrangement simplifies PWB pattern design.
- Reinforced insulation between inputs and outputs. Reinforced insulation between some poles.
- UL, CSA approval.



Ordering Information

Relays with Forcibly Guided Contacts

Type	Sealing	Poles	Contacts	Rated voltage	Model
Standard	Flux-tight	4 poles	3PST-NO, SPST-NC	24 VDC	G7SA-3A1B
			DPST-NO, DPST-NC		G7SA-2A2B
		6 poles	5PST-NO, SPST-NC		G7SA-5A1B
			4PST-NO, DPST-NC		G7SA-4A2B
			3PST-NO, 3PST-NC		G7SA-3A3B

Sockets

Type		LED indicator	Poles	Rated voltage	Model
Track-mounting	Track mounting and screw mounting possible	No	4 poles	---	P7SA-10F
			6 poles		P7SA-14F
		Yes	4 poles	24 VDC	P7SA-10F-ND
			6 poles		P7SA-14F-ND
Back-mounting	PCB terminals	No	4 poles	---	P7SA-10P
			6 poles		P7SA-14P

Model Number Legend

G7SA-□A□B
 1 2

1. NO Contact Poles

- 2: DPST-NO
- 3: 3PST-NO
- 4: 4PST-NO
- 5: 5PST-NO

2. NC Contact Poles

- 1: SPST-NC
- 2: DPST-NC
- 3: 3PST-NC

Specifications

Ratings

Coil

Rated voltage	Rated current	Coil resistance	Must-operate voltage	Must-release voltage	Max. voltage	Power consumption
24 VDC	4 poles: 15 mA 6 poles: 20.8 mA	4 poles: 1,600 Ω 6 poles: 1,152 Ω	75% max. (V)	10% min. (V)	110% (V)	4 poles: Approx. 360 mW 6 poles: Approx. 500 mW

- Note:**
1. The rated current and coil resistance are measured at a coil temperature of 23°C with tolerances of ±15%.
 2. Performance characteristics are based on a coil temperature of 23°C.
 3. The value given for the maximum voltage is for voltages applied instantaneously to the Relay coil (at an ambient temperature of 23°C) and not continuously.

Contacts

Load	Resistive load (cos φ =1)
Rated load	6 A at 250 VAC, 6 A at 30 VDC
Rated carry current	6 A
Max. switching voltage	250 VAC, 125 VDC
Max. switching current	6 A
Max. switching capacity (reference value)	1,500 VA, 180 W

Characteristics

Sockets

Model	Continuous current	Dielectric strength	Insulation resistance
P7SA-14□	6 A (see note 1)	2,500 VAC for 1 min. between poles	100 MΩ min. (see note 2)

- Note:**
1. If the P7SA-1□F is used between 55 and 85°C, reduce the continuous current (from 6 A) by 0.1 A for every degree.
 2. Measurement conditions: Measurement of the same points as for the dielectric strength at 500 VDC.
 3. When using the P7SA-1□F-ND at 24 VDC, use at an ambient operating temperature from -25 to 55°C.

Relays with Forcibly Guided Contacts

Contact resistance	100 mΩ max. (The contact resistance was measured with 1 A at 5 VDC using the voltage-drop method.)	
Operating time (see note 2)	20 ms max.	
Response time (see note 2)	10 ms max. (The response time is the time it takes for the normally open contacts to open after the coil voltage is turned OFF.)	
Release time (see note 2)	20 ms max.	
Maximum operating frequency	Mechanical	36,000 operations/hr
	Rated load	1,800 operations/hr
Insulation resistance	100 MΩ min. (at 500 VDC) (The insulation resistance was measured with a 500-VDC megger at the same places that the dielectric strength was measured.)	
Dielectric strength (see notes 3, 4)	Between coil contacts/different poles: 4,000 VAC, 50/60 Hz for 1 min (2,500 VAC between poles 3-4 in 4-pole Relays or poles 3-5, 4-6, and 5-6 in 6-pole Relays.) Between contacts of same polarity: 1,500 VAC, 50/60 Hz for 1 min	
Vibration resistance	10 to 55 Hz, 1.5-mm double amplitude	
Shock resistance	Destruction	1,000 m/s ²
	Malfunction	100 m/s ²
Durability	Mechanical	10,000,000 operations min. (at approx. 36,000 operations/hr)
	Electrical	100,000 operations min. (at the rated load and approx. 1,800 operations/hr)
Min. permissible load (see note 5) (reference value)	5 VDC, 1 mA	
Ambient temperature (see note 6)	Operating:-40°C to 85°C (with no icing or condensation) Storage:-40°C to 85°C (with no icing or condensation)	
Ambient humidity	Operating:35% to 85% Storage:35% to 85%	
Weight	4 poles: Approx. 22 g 6 poles: Approx. 25 g	
Approved standards	EN61810-1 (IEC61810-1), EN50205, UL508, CSA22.2 No. 14	

- Note:**
1. The values listed above are initial values.
 2. These times were measured at the rated voltage and an ambient temperature of 23°C. Contact bounce time is not included.
 3. Pole 3 refers to terminals 31-32 or 33-34, pole 4 refers to terminals 43-44, pole 5 refers to terminals 53-54, and pole 6 refers to terminals 63-64.
 4. When using a P7SA Socket, the dielectric strength between coil contacts/different poles is 2,500 VAC, 50/60 Hz for 1 min.
 5. Min. permissible load is for a switching frequency of 300 operations/min.
 6. When operating at a temperature between 70°C and 85°C, reduce the rated carry current (6 A at 70°C or less) by 0.1 A for each degree above 70°C.

Dimensions

Note: All units are in millimeters unless otherwise indicated. The diagrams are drawn in perspective.

Relays with Forcibly Guided Contacts

G7SA-3A1B
G7SA-2A2B

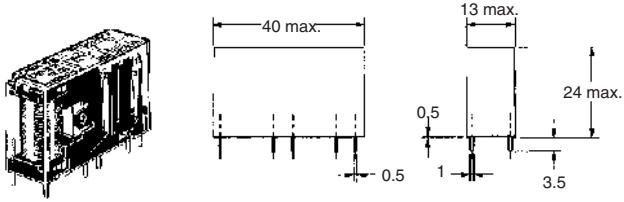

Terminal Arrangement/
Internal Connection Diagram
(Bottom View)

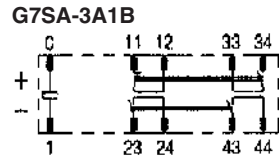

Printed Circuit Board
Design Diagram
(Bottom View)

(±0.1 tolerance)

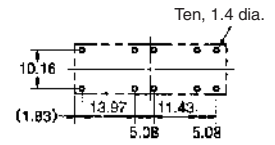

G7SA-2A2B

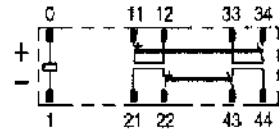

Note: Terminals 23-24, 33-34, and 43-44 are normally open. Terminals 11-12 and 21-22 are normally closed.

G7SA-5A1B
G7SA-4A2B
G7SA-3A3B

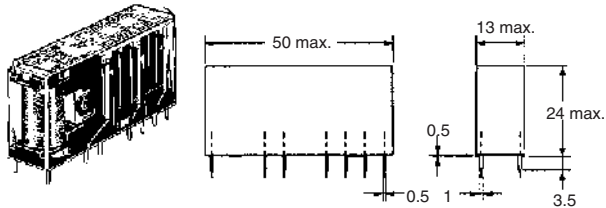

Terminal Arrangement/
Internal Connection Diagram
(Bottom View)

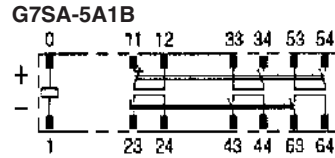

Printed Circuit Board
Design Diagram
(Bottom View)

(±0.1 tolerance)

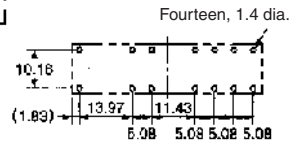

G7SA-4A2B

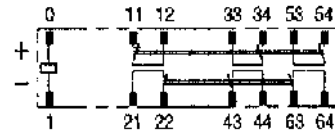

G7SA-3A3B



Note: Terminals 23-24, 33-34, 53-54, and 63-64 are normally open. Terminals 11-12, 21-22, and 31-32 are normally closed.

Sockets

Track-mounting Socket

P7SA-10F, P7SA-10F-ND

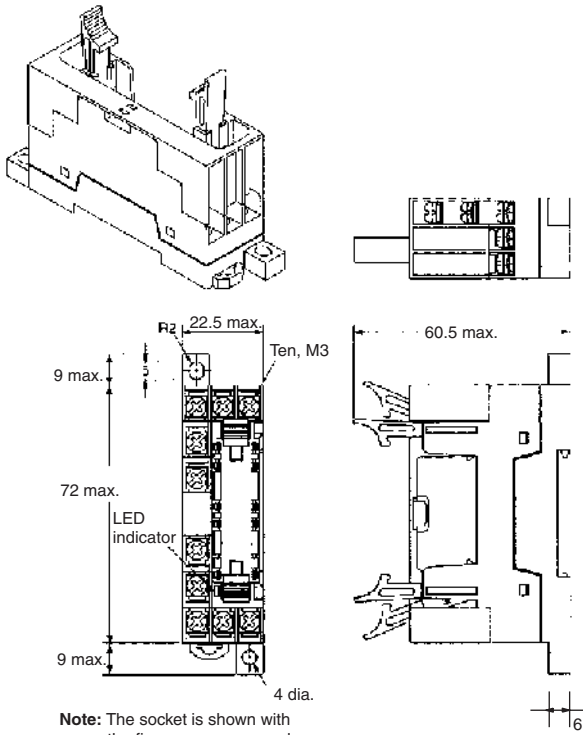

Note: Only the -ND Sockets have LED indicators.

Track-mounting Socket

P7SA-14F, P7SA-14F-ND

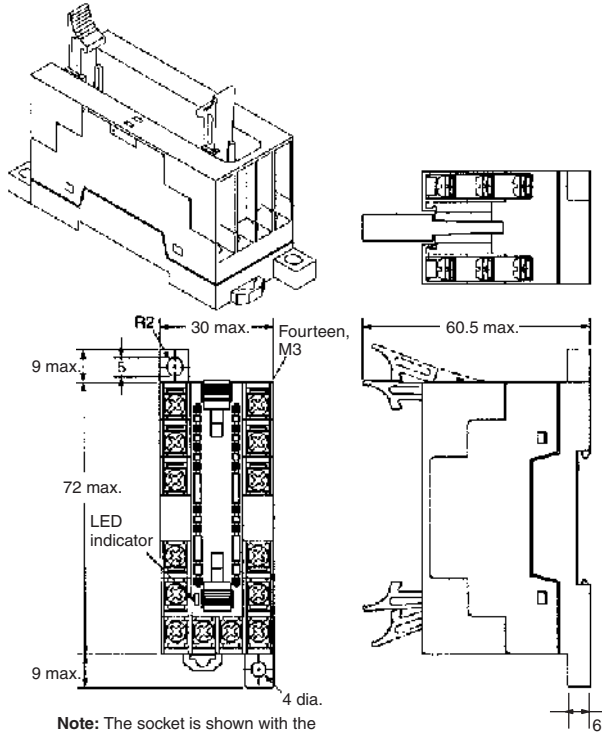

Note: Only the -ND Sockets have LED indicators.

Terminal Installation/Internal Connection Diagram (Top View)

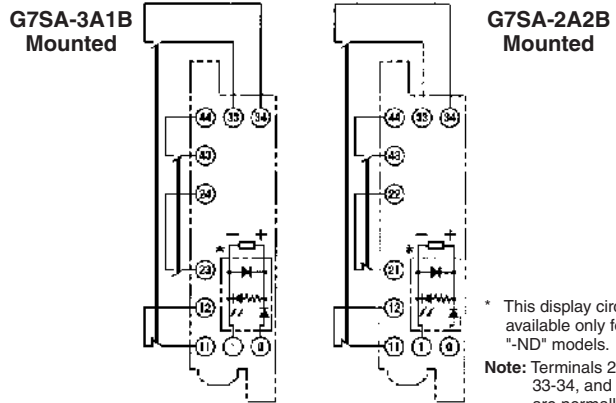

* This display circuit is available only for "-ND" models.

Note: Terminals 23-24, 33-34, and 43-44 are normally open. Terminals 11-12 and 21-22 are normally closed.

Mounting Hole Placement Diagram (Top View)

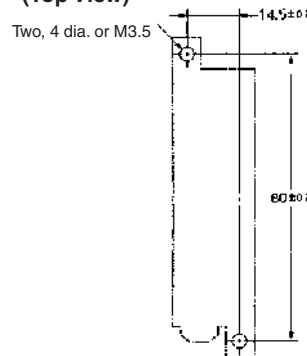

Terminal Arrangement/Internal Connection Diagram (Top View)

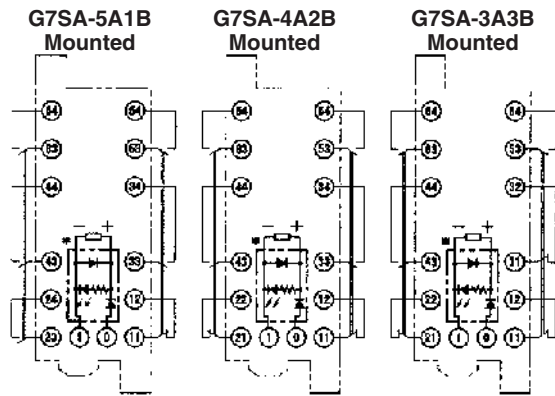

* This display circuit is available only for "-ND" models.

Note: Terminals 23-24, 33-34, 43-44, 53-54, and 63-64 are normally open. Terminals 11-12, 21-22, and 31-32 are normally closed.

Mounting Hole Placement Diagram (Top View)

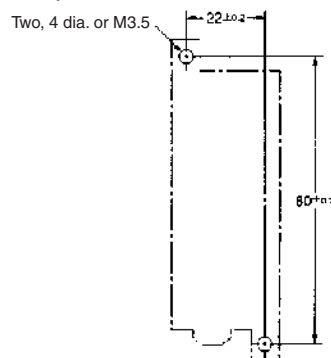

P7SA-10P Back-mounting Socket (for PCB)

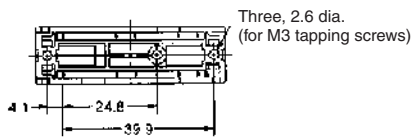
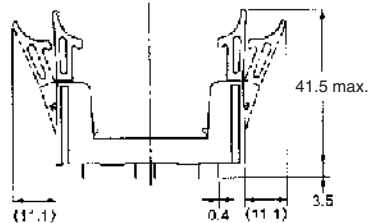
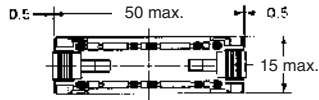
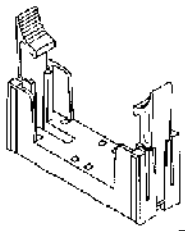

Terminal Arrangement/Internal Connection Diagram (Bottom View)

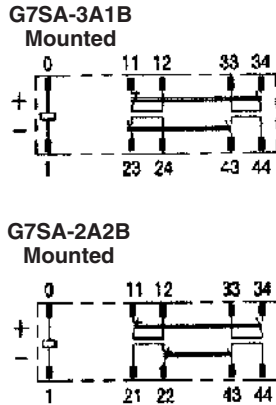

Mounting Hole Placement (Bottom View)
(±0.1 tolerance)

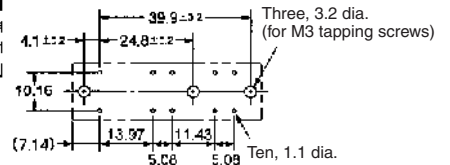

Note: Terminals 23-24, 33-34, and 43-44 are normally open. Terminals 11-12 and 21-22 are normally closed.

P7SA-14P Back-mounting Socket (for PCB)

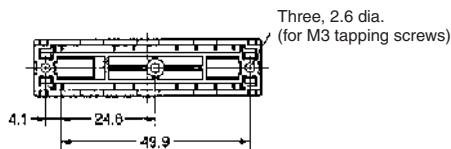
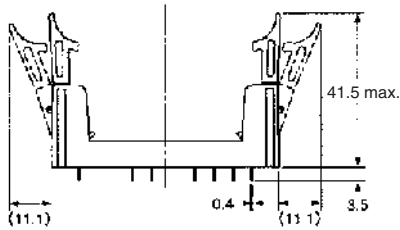
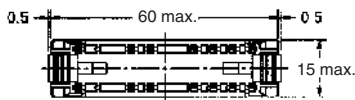
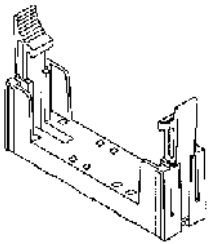

Terminal Arrangement/Internal Connection Diagram (Bottom View)

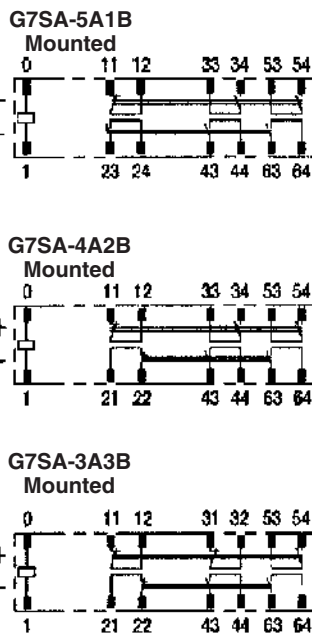

Mounting Hole Placement (Bottom View)
(±0.1 tolerance)

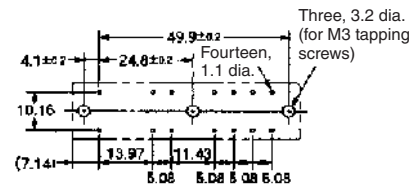

Note: Terminals 23-24, 33-34, 43-44, 53-54, and 63-64 are normally open. Terminals 11-12, 21-22, and 31-32 are normally closed.

Precautions

Caution

Do not touch the terminal area of the Relays or the socket terminal area (charged area) while power is ON. Electric shock will result.

Relays with Forcibly Guided Contacts

A Relay with Forcibly Guided Contacts is a Relay with which a safety category circuit can be configured.

Wiring

Use one of the following wires to connect to the P7SA-10F/10F-ND/14F/14F-ND.

Stranded wire: 0.75 to 1.5 mm²

Solid wire: 1.0 to 1.5 mm²

Tighten each screw of the P7SA-10F/10F-ND/14F/14F-ND to a torque of 0.98 N·m securely.

Wire the terminals correctly with no mistakes in coil polarity, otherwise the G7SA will not operate.

Cleaning

The G7SA is not of enclosed construction. Therefore, do not wash the G7SA with water or detergent.

Forcibly Guided Contacts (from EN50205)

If an NO contact becomes welded, all NC contacts will maintain a minimum distance of 0.5 mm when the coil is not energized. Likewise if an NC contact becomes welded, all NO contacts will maintain a minimum distance of 0.5 mm when the coil is energized.

Correct Use

Relays with Forcibly Guided Contacts

While the Relay with Forcibly Guided Contacts has the previously described forcibly guided contact structure, it is basically the same as an ordinary relay in other respects. Rather than serving to prevent malfunctions, the forcibly guided contact structure enables another circuit to detect the condition following a contact weld or other malfunction. Accordingly, when a contact weld occurs in a Relay with Forcibly Guided Contacts, depending on the circuit configuration, the power may not be interrupted, leaving the Relay in a potentially dangerous condition (as shown in Fig. 1.)

To configure the power control circuit to interrupt the power when a contact weld or other malfunction occurs, and to prevent restarting until the problem has been eliminated, add another Relay with Forcibly Guided Contacts or similar Relay in combination to provide redundancy and a self-monitoring function to the circuit (as shown in Fig. 2).

The G9S/G9SA Safety Relay Unit, which combines Relays such as the Relay with Forcibly Guided Contacts in order to provide the above-described functions, is available for this purpose. By connecting a contactor with appropriate input and output to the Safety Relay Unit, the circuit can be equipped with redundancy and a self-monitoring function.

