

**400mA High PSRR, LDO Regulators****Features**

- Low, 90µA No-Load Supply Current
- Guaranteed 400mA Output Current
- PSRR=65dB @ 120Hz; 55dB @ 1kHz
- Over-Temperature Protection and Short-Circuit Protection
- Output Voltage: 1.20V~5.00V (G9161-XXX)
- Stable with low cost ceramic capacitors

Applications

- CD ROM or DVD ROM
- DVD Player
- Audio Codec

General Description

The G9161 series is a low supply current, high PSRR, and low dropout linear regulator that comes in a SOT-89, SOT-223, TO-252 and SOP-8 with Power PAD package. The supply current at no-load is 90µA. Operating voltage range is from 2.50V to 5.50V. The over-current protection limit is set at 550mA typical. An over-temperature protection circuit is built-in in the Device to prevent thermal overload.

The output voltage range is from 1.2V to 5.0V.

Ordering Information

ORDER NUMBER	MARKING	VOLTAGE	TEMP. RANGE	PACKAGE (Pb free)
G9161-120T25U	9161AA	1.2V	-40°C~ +85°C	SOT-89
G9161-120T45U	9161-120	1.2V	-40°C~ +85°C	TO-252
G9161-120T65U	9161-120	1.2V	-40°C~ +85°C	SOT-223
G9161-120F1U	9161AA	1.2V	-40°C~ +85°C	SOP-8 (FD)

For other output voltage, please contact us at sales@gmt.com.tw

Note: T2: SOT-89, T4: TO-252, T6: SOT-223, F1: SOP-8 (FD)

5: Bonding Code

U: Tape & Reel

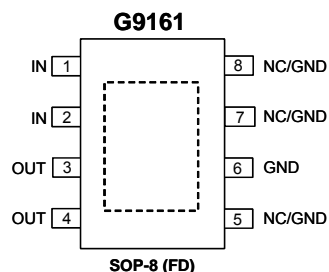
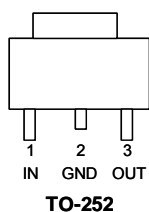
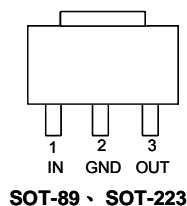
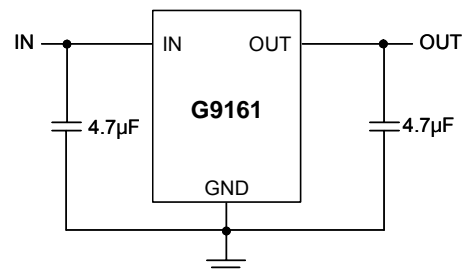
Pin Configuration**Typical Application Circuit**

Note: Recommend connecting the Thermal Pad to the GND for excellent power dissipation.

**Selector Guide**

ORDER NUMBER	OUTPUT VOLTAGE (V)	MARKING
G9161-120T25U	1.20	9161AA
G9161-130T25U	1.30	9161AB
G9161-140T25U	1.40	9161AC
G9161-150T25U	1.50	9161AD
G9161-160T25U	1.60	9161AE
G9161-170T25U	1.70	9161AF
G9161-180T25U	1.80	9161AG
G9161-190T25U	1.90	9161AH
G9161-200T25U	2.00	9161AI
G9161-210T25U	2.10	9161AJ
G9161-220T25U	2.20	9161AK
G9161-230T25U	2.30	9161AL
G9161-240T25U	2.40	9161AM
G9161-250T25U	2.50	9161AN
G9161-260T25U	2.60	9161AO
G9161-270T25U	2.70	9161AP
G9161-280T25U	2.80	9161AQ
G9161-285T25U	2.85	9161AR
G9161-290T25U	2.90	9161AS
G9161-300T25U	3.00	9161AT
G9161-310T25U	3.10	9161AU
G9161-315T25U	3.15	9161AV
G9161-320T25U	3.20	9161AW
G9161-330T25U	3.30	9161AX
G9161-340T25U	3.40	9161AY
G9161-350T25U	3.50	9161AZ
G9161-360T25U	3.60	9161BA
G9161-370T25U	3.70	9161BB
G9161-380T25U	3.80	9161BC
G9161-390T25U	3.90	9161BD
G9161-400T25U	4.00	9161BE
G9161-410T25U	4.10	9161BF
G9161-420T25U	4.20	9161BG
G9161-430T25U	4.30	9161BH
G9161-440T25U	4.40	9161BI
G9161-450T25U	4.50	9161BJ
G9161-460T25U	4.60	9161BK
G9161-470T25U	4.70	9161BL
G9161-475T25U	4.75	9161BM
G9161-480T25U	4.80	9161BN
G9161-490T25U	4.90	9161BO
G9161-500T25U	5.00	9161BP

T2: SOT-89

**Selector Guide**

ORDER NUMBER	OUTPUT VOLTAGE (V)	MARKING
G9161-120T45U	1.20	9161-120
G9161-130T45U	1.30	9161-130
G9161-140T45U	1.40	9161-140
G9161-150T45U	1.50	9161-150
G9161-160T45U	1.60	9161-160
G9161-170T45U	1.70	9161-170
G9161-180T45U	1.80	9161-180
G9161-190T45U	1.90	9161-190
G9161-200T45U	2.00	9161-200
G9161-210T45U	2.10	9161-210
G9161-220T45U	2.20	9161-220
G9161-230T45U	2.30	9161-230
G9161-240T45U	2.40	9161-240
G9161-250T45U	2.50	9161-250
G9161-260T45U	2.60	9161-260
G9161-270T45U	2.70	9161-270
G9161-280T45U	2.80	9161-280
G9161-285T45U	2.85	9161-285
G9161-290T45U	2.90	9161-290
G9161-300T45U	3.00	9161-300
G9161-310T45U	3.10	9161-310
G9161-315T45U	3.15	9161-315
G9161-320T45U	3.20	9161-320
G9161-330T45U	3.30	9161-330
G9161-340T45U	3.40	9161-340
G9161-350T45U	3.50	9161-350
G9161-360T45U	3.60	9161-360
G9161-370T45U	3.70	9161-370
G9161-380T45U	3.80	9161-380
G9161-390T45U	3.90	9161-390
G9161-400T45U	4.00	9161-400
G9161-410T45U	4.10	9161-410
G9161-420T45U	4.20	9161-420
G9161-430T45U	4.30	9161-430
G9161-440T45U	4.40	9161-440
G9161-450T45U	4.50	9161-450
G9161-460T45U	4.60	9161-460
G9161-470T45U	4.70	9161-470
G9161-475T45U	4.75	9161-475
G9161-480T45U	4.80	9161-480
G9161-490T45U	4.90	9161-490
G9161-500T45U	5.00	9161-500

T4: TO-252

**Selector Guide**

ORDER NUMBER	OUTPUT VOLTAGE (V)	MARKING
G9161-120T65U	1.20	9161-120
G9161-130T65U	1.30	9161-130
G9161-140T65U	1.40	9161-140
G9161-150T65U	1.50	9161-150
G9161-160T65U	1.60	9161-160
G9161-170T65U	1.70	9161-170
G9161-180T65U	1.80	9161-180
G9161-190T65U	1.90	9161-190
G9161-200T65U	2.00	9161-200
G9161-210T65U	2.10	9161-210
G9161-220T65U	2.20	9161-220
G9161-230T65U	2.30	9161-230
G9161-240T65U	2.40	9161-240
G9161-250T65U	2.50	9161-250
G9161-260T65U	2.60	9161-260
G9161-270T65U	2.70	9161-270
G9161-280T65U	2.80	9161-280
G9161-285T65U	2.85	9161-285
G9161-290T65U	2.90	9161-290
G9161-300T65U	3.00	9161-300
G9161-310T65U	3.10	9161-310
G9161-315T65U	3.15	9161-315
G9161-320T65U	3.20	9161-320
G9161-330T65U	3.30	9161-330
G9161-340T65U	3.40	9161-340
G9161-350T65U	3.50	9161-350
G9161-360T65U	3.60	9161-360
G9161-370T65U	3.70	9161-370
G9161-380T65U	3.80	9161-380
G9161-390T65U	3.90	9161-390
G9161-400T65U	4.00	9161-400
G9161-410T65U	4.10	9161-410
G9161-420T65U	4.20	9161-420
G9161-430T65U	4.30	9161-430
G9161-440T65U	4.40	9161-440
G9161-450T65U	4.50	9161-450
G9161-460T65U	4.60	9161-460
G9161-470T65U	4.70	9161-470
G9161-475T65U	4.75	9161-475
G9161-480T65U	4.80	9161-480
G9161-490T65U	4.90	9161-490
G9161-500T65U	5.00	9161-500

T6: SOT-223

**Selector Guide**

ORDER NUMBER	OUTPUT VOLTAGE (V)	MARKING
G9161-120F1U	1.20	9161AA
G9161-130 F1U	1.30	9161AB
G9161-140 F1U	1.40	9161AC
G9161-150 F1U	1.50	9161AD
G9161-160 F1U	1.60	9161AE
G9161-170 F1U	1.70	9161AF
G9161-180 F1U	1.80	9161AG
G9161-190 F1U	1.90	9161AH
G9161-200 F1U	2.00	9161AI
G9161-210 F1U	2.10	9161AJ
G9161-220F1U	2.20	9161AK
G9161-230F1U	2.30	9161AL
G9161-240F1U	2.40	9161AM
G9161-250F1U	2.50	9161AN
G9161-260F1U	2.60	9161AO
G9161-270F1U	2.70	9161AP
G9161-280F1U	2.80	9161AQ
G9161-285F1U	2.85	9161AR
G9161-290F1U	2.90	9161AS
G9161-300 F1U	3.00	9161AT
G9161-310 F1U	3.10	9161AU
G9161-315 F1U	3.15	9161AV
G9161-320 F1U	3.20	9161AW
G9161-330 F1U	3.30	9161AX
G9161-340 F1U	3.40	9161AY
G9161-350 F1U	3.50	9161AZ
G9161-360 F1U	3.60	9161BA
G9161-370 F1U	3.70	9161BB
G9161-380 F1U	3.80	9161BC
G9161-390 F1U	3.90	9161BD
G9161-400 F1U	4.00	9161BE
G9161-410 F1U	4.10	9161BF
G9161-420 F1U	4.20	9161BG
G9161-430 F1U	4.30	9161BH
G9161-440 F1U	4.40	9161BI
G9161-450 F1U	4.50	9161BJ
G9161-460 F1U	4.60	9161BK
G9161-470 F1U	4.70	9161BL
G9161-475 F1U	4.75	9161BM
G9161-480 F1U	4.80	9161BN
G9161-490 F1U	4.90	9161BO
G9161-500 F1U	5.00	9161BP

F1: SOP-8 (FD)

**Absolute Maximum Ratings**

Input Voltage	7V
Power Dissipation Internally Limited	
Maximum Junction Temperature	150°C
Storage Temperature Range	-65°C ≤ T _J ≤ +150°C
Reflow Temperature (soldering, 10sec)	260°C
Thermal Resistance Junction to Ambient, (θ _{JA}) ⁽¹⁾	
SOT-89	153°C/W
TO-252	102°C/W
SOT-223	118°C/W
SOP-8 (FD)	162°C/W
Thermal Resistance Junction to Case, (θ _{Jc})	
SOT-89	48°C/W
TO-252	8°C/W
SOT-223	20°C/W
SOP-8 (FD)	12°C/W

Operating Conditions

(Note 1)

Input Voltage	2.5V ~ 5.5V
Temperature Range	-40°C ≤ T _A ≤ 85°C

Note ⁽¹⁾: See Recommended Minimum Footprint.**Electrical Characteristics**(V_{IN}=+3.6V, T_A=T_J=+25°C, C_{IN}=4.7μF, C_{OUT}=4.7μF, unless otherwise noted.) (Note 1)

PARAMETER	SYMBOL	CONDITION	MIN	TYP	MAX	UNIT	
Input Voltage (Note 2)	V _{IN}		2.5	---	5.5	V	
Output Voltage Accuracy	V _{OUT}	V _{OUT} ≥ 2.50V, I _{OUT} = 1mA	-2	---	2	%	
		2.50V > V _{OUT} ≥ 1.80V, I _{OUT} = 1mA	-3	---	3		
		1.80V > V _{OUT} ≥ 1.20V, I _{OUT} = 1mA	-4	---	4		
Maximum Output Current			400	---	---	mA	
Current Limit (Note 4)	I _{LIM}		400	550	---	mA	
Short Circuit Current	I _{SC}		---	280	---	mA	
Ground Pin Current	I _Q		---	90	---	μA	
Dropout Voltage (Note 5)	V _{DROP}	I _{OUT} = 400mA	V _{OUT} = 1.20V	---	2	2.3	V
			V _{OUT} = 1.80V	---	1.4	1.7	
			V _{OUT} = 2.50V	---	0.8	1	
			V _{OUT} = 3.30V	---	0.48	0.67	
Line Regulation	ΔV _{LNR}	SET=GND, V _{IN} =V _(STD) +0.1V, to 6.2V I _{OUT} =10mA	---	0.06	0.12	%/V	
Load Regulation	ΔV _{LDR}	I _{OUT} =10mA to 400mA	---	---	0.02	%/mA	
Ripple Rejection	PSRR	F=120Hz, 0.49V _{P-P} , I _{OUT} =10mA	---	65	---	dB	
Thermal Protection							
Thermal Shutdown Temperature	T _{SHDN}		---	145	---	°C	
Thermal Shutdown Hysteresis	ΔT _{SHDN}		---	25	---	°C	

Note 1: Limits is 100% production tested at T_A= +25°C. Low duty pulse techniques are used during test to maintain junction temperature as close to ambient as possible.

Note 2: Guaranteed by line regulation test.

Note 3: Adjustable mode only.

Note 4: Not tested. For design purposes, the current limit should be considered 400mA minimum to 650mA maximum.

Note 5: The dropout voltage is defined as (V_{IN}-V_{OUT}) when V_{OUT} is 100mV below the target value of V_{OUT}. The performance of every G9161 part, see "Typical Performance Characteristics".



Typical Performance Characteristics

($V_{IN}=3.6V$, $V_{OUT}=1.2V$, $C_{IN}=4.7\mu F$, $C_{OUT}=4.7\mu F$, $T_A=25^\circ C$, unless otherwise noted.)

Line Transient Response

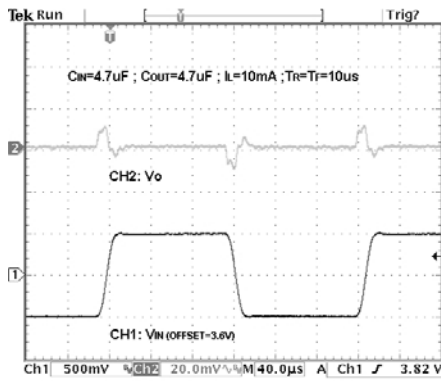

Load Transient Response

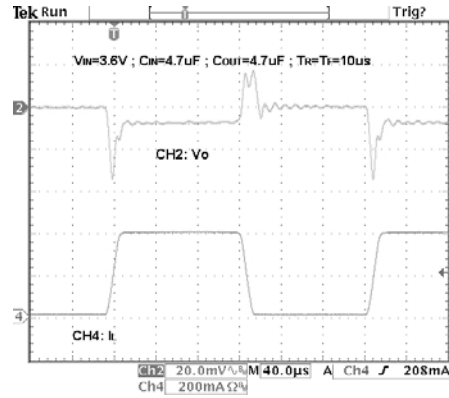

Short Circuit Current

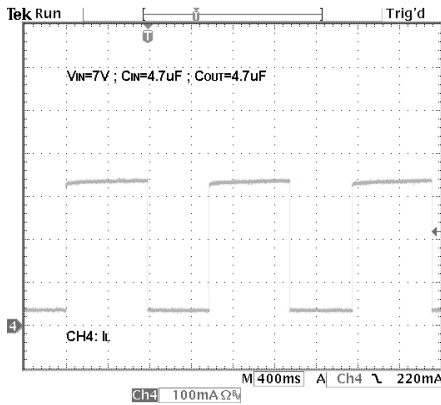

Ripple Rejection

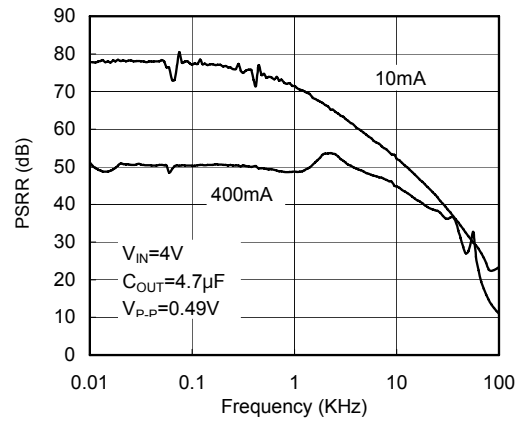

Overcurrent Protection Characteristics

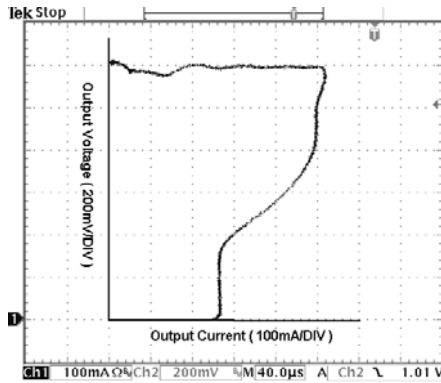

Start-up

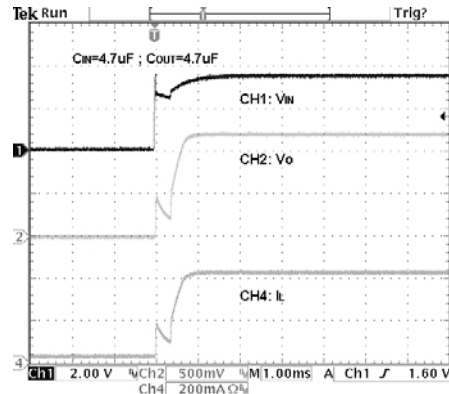

Typical Performance Characteristics (continued)

SOT-89 Max. Power Dissipation vs. PCB Top Copper Area

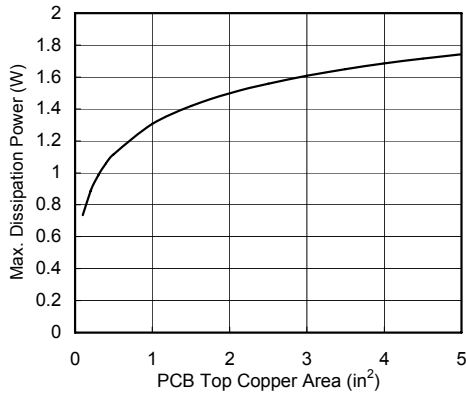

SOT-89 Max. Power Dissipation vs. T_{AMB}

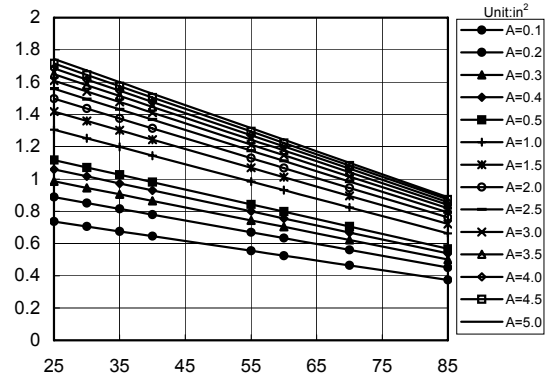

SOT-223 Max. Power Dissipation vs. PCB Top Copper Area

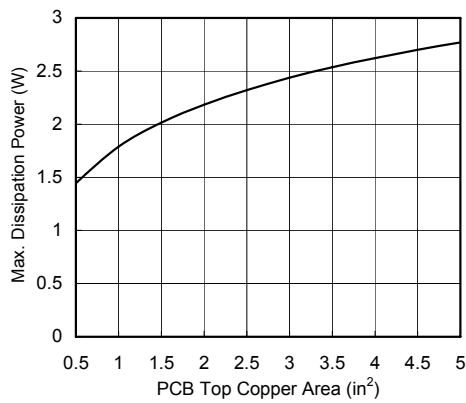

SOT-223 Max. Power Dissipation vs. T_{AMB}

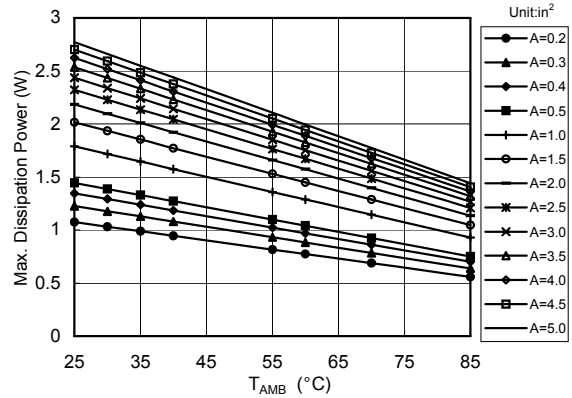

TO-252 Max. Power Dissipation vs. PCB Top Copper Area

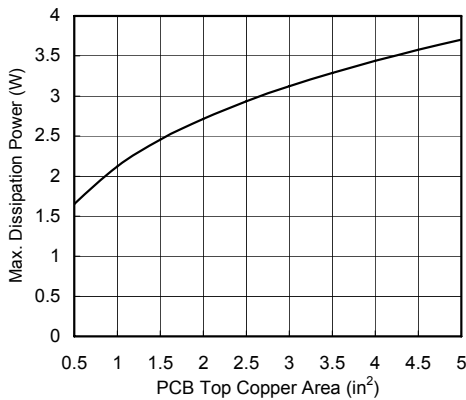

TO-252 Max. Power Dissipation vs. T_{AMB}

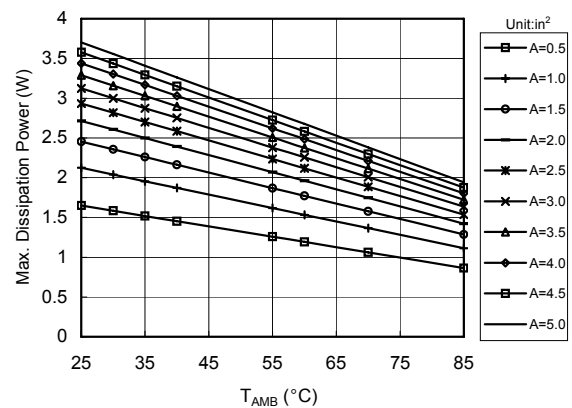

Typical Performance Characteristics (continued)

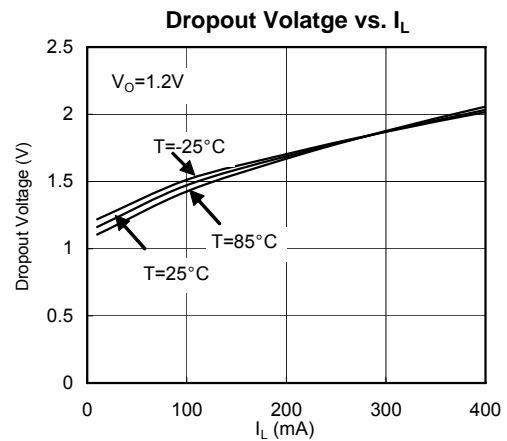
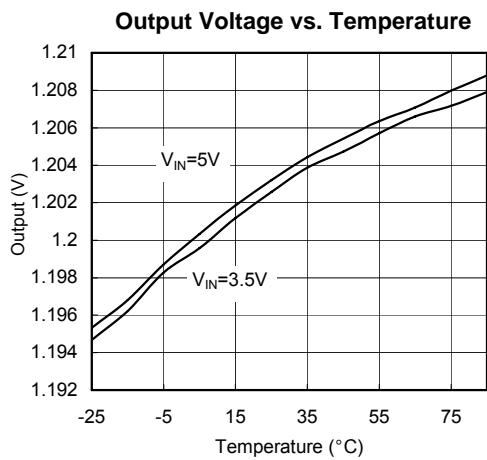
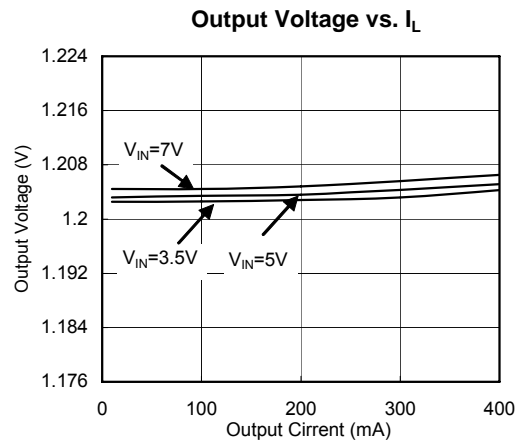
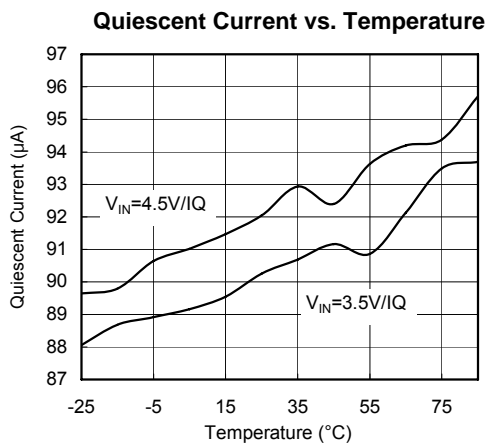
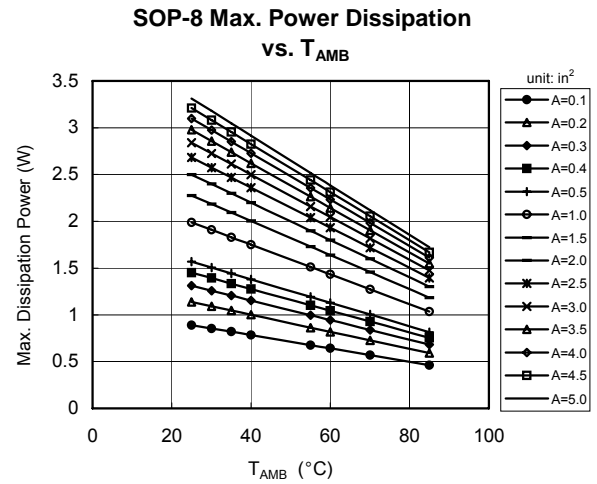
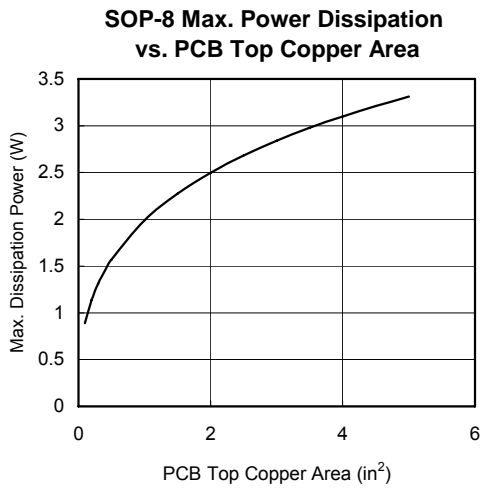

Recommended Minimum Footprint

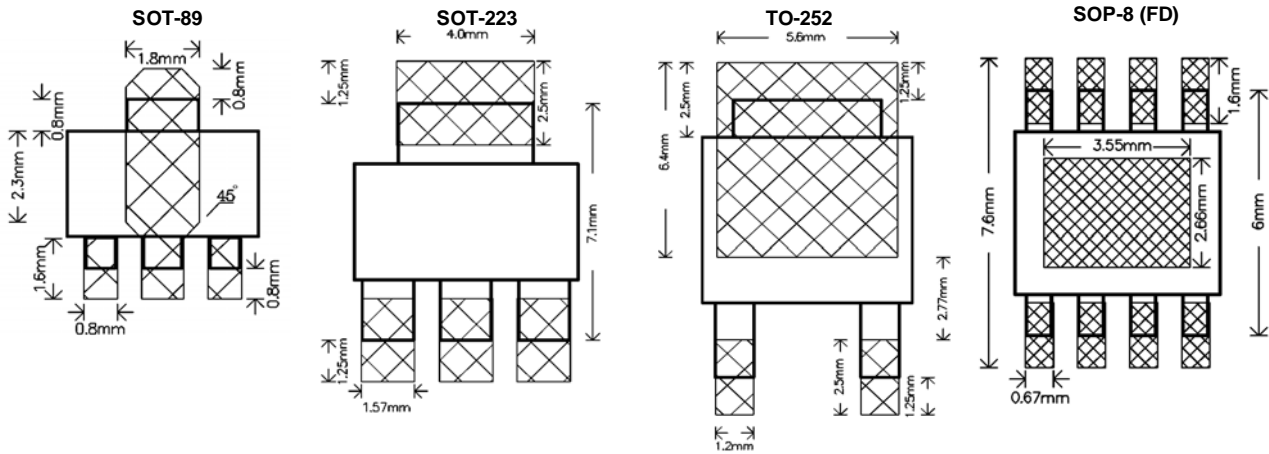

Recommended Ground Layout for Power Dissipation

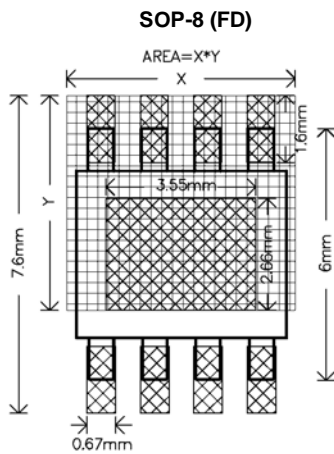

Pin Description

PIN				NAME	FUNCTION
SOT-89	TO-252	SOT-223	SOP-8 (FD)		
1	1	1	1,2	IN	Regulator Input. Supply voltage can range from +2.5V to +5.5V. Bypass with 1 μ F to GND
2	2	2	6	GND	Ground. This pin also functions as a heatsink. Solder to large pads on the circuit board ground plane to maximize thermal dissipation.
3	3	3	3,4	OUT	Regulator Output. Sources up to 300mA. Bypass with a 1 μ F, <0.2 Ω typical ESR capacitor to GND.
			5,7,8	NC/GND	Connect to GND for heatsink.
			Thermal Pad		Recommend connecting the Thermal Pad to the GND for excellent power dissipation.

Detailed Description

Over Current Protection

The G9161 uses a current sense-resistor to monitor the output current. A portion of the PMOS output transistor's current is mirrored to a resistor such that the voltage across this resistor is proportional to the output current. Once the output current exceeds limit threshold, G9161 would be protected with a limited output current. Further more, when the output is short to ground, the output current would be folded-back to a less limit.

Over Temperature Protection

To prevent abnormal temperature from occurring, the G9161 has a built-in temperature monitoring circuit. When it detects the temperature is above 145°C, the output transistor is turned off. When the IC is cooled down to below 120°C, the output is turned on again. In this way, the G9161 will be protected against abnormal junction temperature during operation.

Applications Information

Capacitor Selection and Regulator Stability

Normally, use a 1 μ F capacitor on the input and a 1 μ F capacitor on the output of the G9161. Larger input capacitor values and lower ESR provide better supply-noise rejection and transient response. A higher-value input capacitor (10 μ F) may be necessary if large, fast transients are anticipated and the device is located several inches from the power source.

Power-Supply Rejection and Operation from Sources Other than Batteries

The G9161 is designed to deliver low dropout voltages and low quiescent currents in battery powered systems. Power-supply rejection is 65dB at low frequencies. As the frequency increases above 20kHz, the output capacitor is the major contributor to the rejection of power-supply noise.

When operating from sources other than batteries, improve supply-noise rejection and transient response by increasing the values of the input and output capacitors, and using passive filtering techniques.

Load Transient Considerations

The G9161 load-transient response graphs show two components of the output response: a DC shift of the output voltage due to the different load currents, and the transient response. Typical overshoot for step changes in the load current from 10mA to 300mA is 8mV. Increasing the output capacitor's value and decreasing its ESR attenuates transient spikes.

Input-Output (Dropout) Voltage

A regulator's minimum input-output voltage differential (or dropout voltage) determines the lowest usable supply voltage. In battery-powered systems, this will determine the useful end-of-life battery voltage. Because the G9161 use a P-channel MOSFET pass transistor, their dropout voltage is a function of $R_{DS(ON)}$ multiplied by the load current.

Package Information

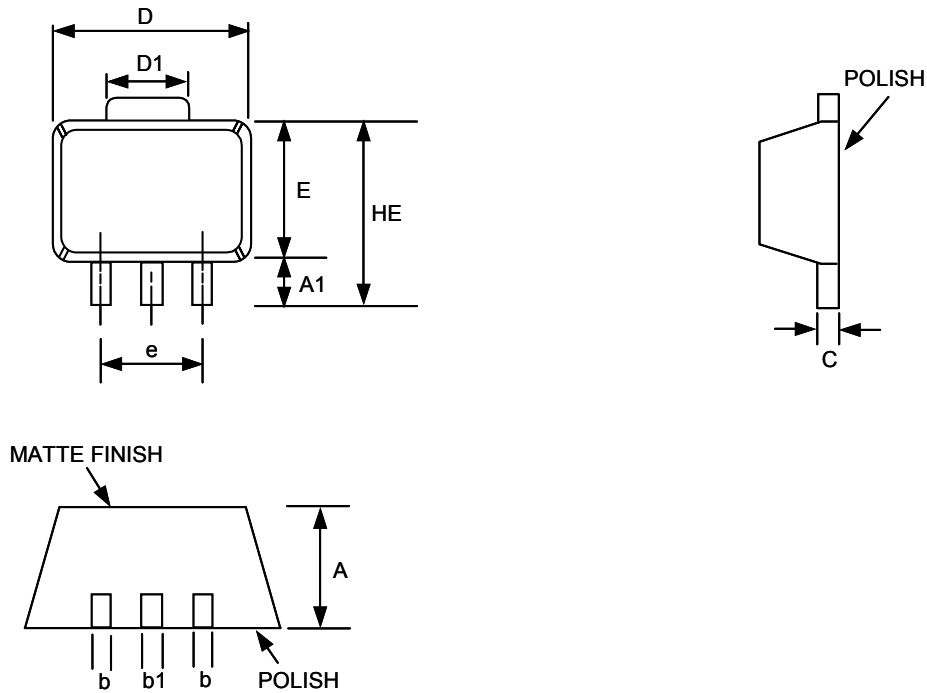

SOT-89 (T2) Package

SYMBOL	DIMENSIONS IN MILLIMETER			DIMENSIONS IN INCH		
	MIN	NOM	MAX	MIN	NOM	MAX
A	1.40	1.50	1.60	0.055	0.059	0.063
A1	0.80	1.04	-----	0.031	0.041	-----
b	0.36	0.42	0.48	0.014	0.016	0.018
b1	0.41	0.47	0.53	0.016	0.018	0.020
C	0.38	0.40	0.43	0.014	0.015	0.017
D	4.40	4.50	4.60	0.173	0.177	0.181
D1	1.40	1.60	1.75	0.055	0.062	0.069
HE	-----	-----	4.25	-----	-----	0.167
E	2.40	2.50	2.60	0.094	0.098	0.102
e	2.90	3.00	3.10	0.114	0.118	0.122

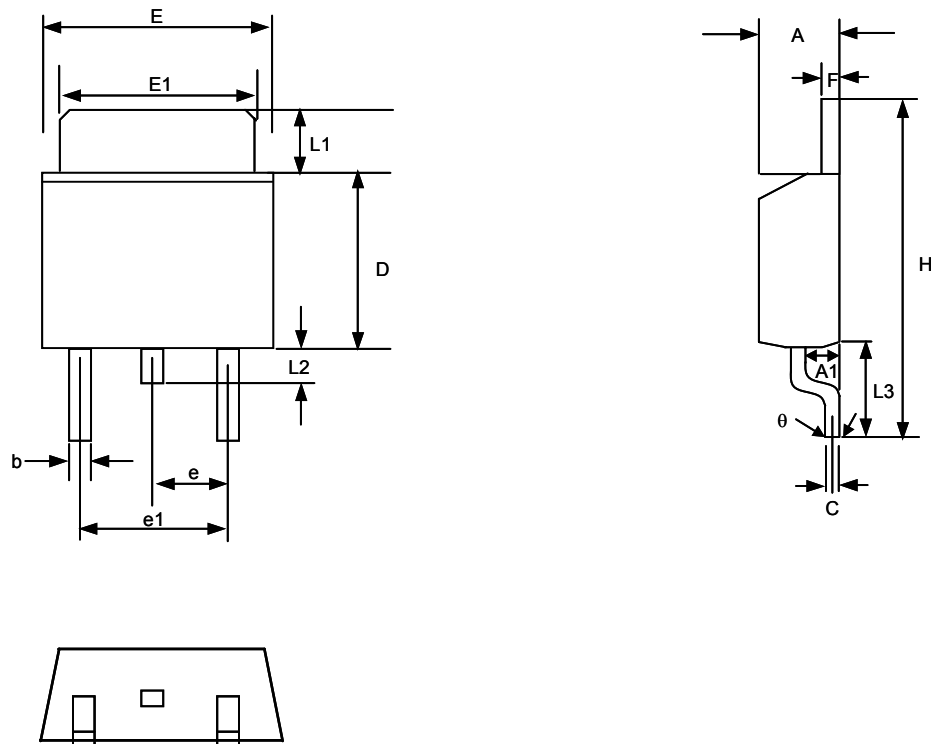

TO-252 (T4) Package

SYMBOL	MILLIMETERS		INCHES	
	MIN.	MAX.	MIN.	MAX.
A	2.19	2.38	0.086	0.094
A1	0.89	1.27	0.035	0.050
b	0.64	0.89	0.025	0.035
C	0.46	0.58	0.018	0.023
D	5.97	6.22	0.235	0.245
E	6.35	6.73	0.250	0.265
E1	5.21	5.46	0.205	0.215
e	2.26BSC		0.09BSC	
e1	3.96	5.18	0.156	0.204
F	0.46	0.58	0.018	0.023
L1	0.89	2.03	0.035	0.080
L2	0.64	1.02	0.025	0.040
L3	2.40	2.80	0.095	0.110
H	9.40	10.40	0.370	0.410
θ	0°	4°	0°	4°

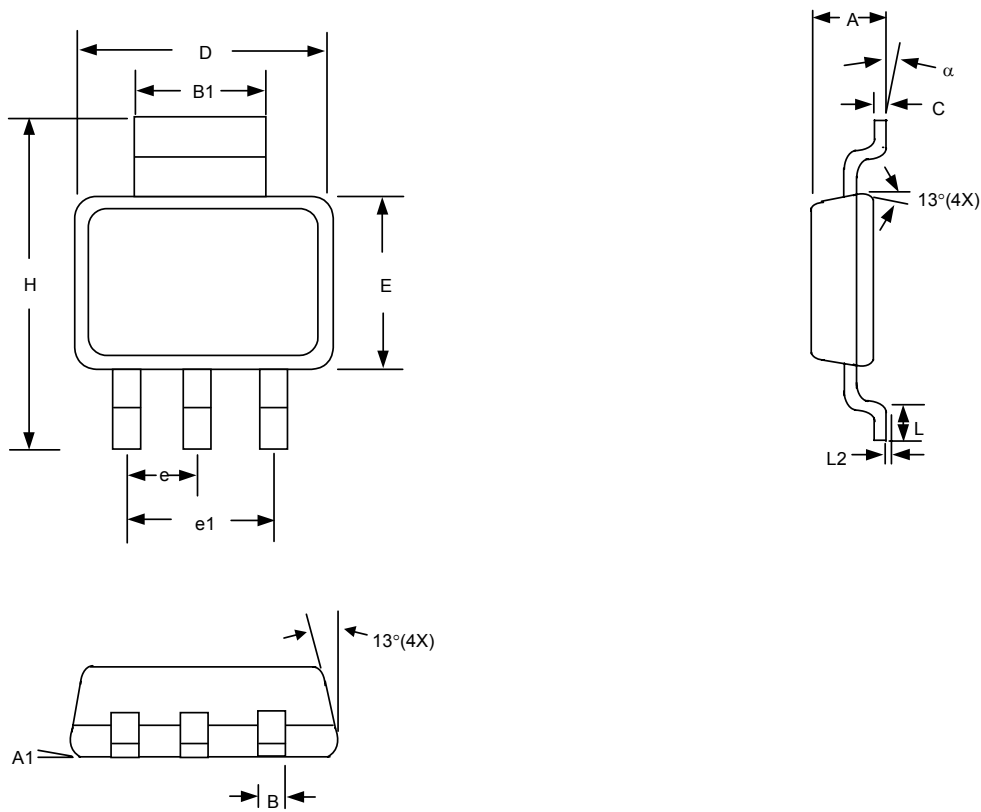

SOT-223 (T6) Package

SYMBOL	MILLIMETER		INCH	
	MIN	MAX	MIN	MAX
A	1.55	1.80	0.061	0.071
A1	0.02	0.12	0.0008	0.0047
B	0.60	0.80	0.024	0.031
B1	2.90	3.10	0.114	0.122
C	0.24	0.32	0.009	0.013
D	6.30	6.70	0.248	0.264
E	3.30	3.70	0.130	0.146
e	2.30 BSC		0.090 BSC	
e1	4.60 BSC		0.181 BSC	
H	6.70	7.30	0.264	0.287
L	0.90 MIN		0.036 MIN	
L2	0.06 BSC		0.0024 BSC	
α	0°	10°	0°	10°

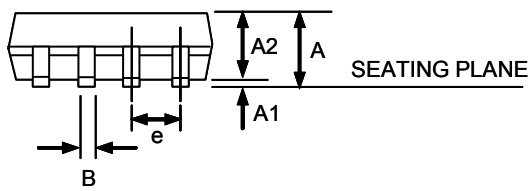
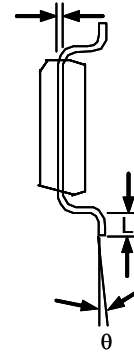
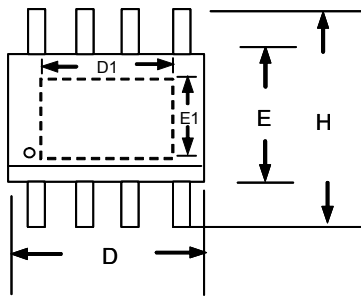

SOP-8 (FD) Package

Note:

1. JEDEC Outline: MS-012 AA/E.P. Version: N/A
2. Dimension "D" does not include mold flash, protrusions or gate burrs. Mold flash, protrusions and gate burrs shall not exceed .15mm (.006in) per side.
3. Dimensions "E" does not include inter-lead flash, or protrusions inter-lead flash and protrusions shall not exceed .25mm (.010in) per side.

SYMBOL	DIMENSION IN MM		DIMENSION IN INCH	
	MIN.	MAX.	MIN.	MAX.
A	1.397	1.753	0.053	0.069
A1	0.00	0.13	0.000	0.005
A2	1.40 TYP		0.055 TYP	
B	0.330	0.508	0.013	0.020
D	4.801	5.004	0.189	0.197
E	3.810	3.988	0.150	0.157
e	1.27 TYP		0.05 TYP	
H	5.791	6.198	0.228	0.244
L	0.508	0.711	0.020	0.028
θ	0°	8°	0°	8°
D1	3.048	3.556	0.120	0.140
E1	2.159	2.667	0.085	0.105

Taping Specification

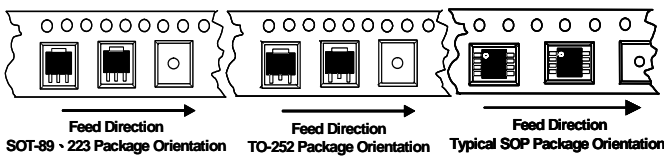

PACKAGE	Q'TY/BY REEL
SOT-89	1,000 ea
TO-252	2,500 ea
SOT-223	2,500 ea
SOP-8 (FD)	2,500 ea

GMT Inc. does not assume any responsibility for use of any circuitry described, no circuit patent licenses are implied and GMT Inc. reserves the right at any time without notice to change said circuitry and specifications.