

T-41-73

# GP1S58 Compact Photointerrupter

## ■ Features

1. Compact type
2. High sensing accuracy (Slit width : 0.5mm)
3. PWB mounting type
4. With positioning pin

## ■ Applications

1. OA equipment, such as FDDs, printers, facsimiles
2. VCRs

## ■ Outline Dimensions (Unit : mm)

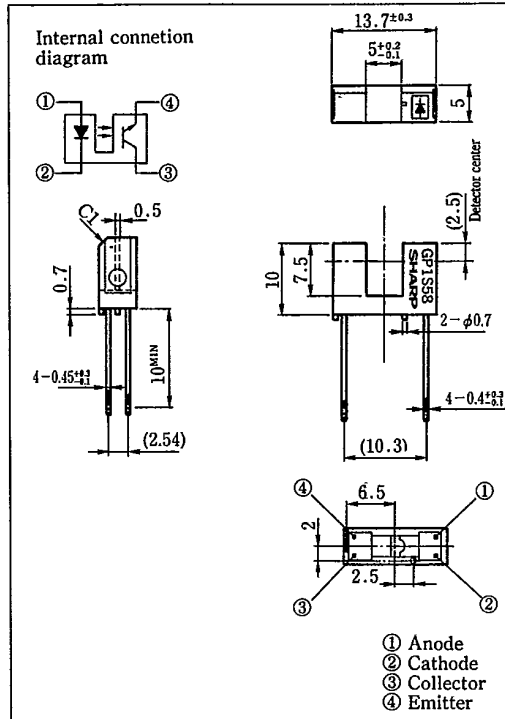

## ■ Absolute Maximum Ratings

(Ta=25°C)

	Parameter	Symbol	Rating	Unit
Input	Forward current	$I_F$	50	mA
	*1 Peak forward current	$I_{FM}$	1	A
	Reverse voltage	$V_R$	6	V
	Power dissipation	$P$	75	mW
Output	Collector-emitter voltage	$V_{CEO}$	35	V
	Emitter-collector voltage	$V_{ECO}$	6	V
	Collector current	$I_C$	20	mA
	Collector power dissipation	$P_C$	75	mW
	Operating temperature	$T_{opr}$	-25 ~ +85	°C
	Storage temperature	$T_{stg}$	-40 ~ +100	°C
	*2 Soldering temperature	$T_{sol}$	260	°C

\*1 Pulse width ≤ 100μs, Duty ratio = 0.01

\*2 For 5 seconds



T-41-73

■ Electro-optical Characteristics

(Ta=25°C)

	Parameter	Symbol	Conditions	MIN.	TYP.	MAX.	Unit
Input	Forward voltage	$V_F$	$I_F=20\text{mA}$	—	1.2	1.4	V
	Peak forward voltage	$V_{FM}$	$I_{FM}=0.5\text{A}$	—	3	4	V
	Reverse current	$I_R$	$V_R=3\text{V}$	—	—	10	$\mu\text{A}$
Output	Collector dark current	$I_{CEO}$	$V_{CE}=20\text{V}$	—	$10^{-9}$	$10^{-7}$	A
Transfer characteristics	Current transfer ratio	CTR	$I_F=20\text{mA}, V_{CE}=5\text{V}$	2.5	—	75	%
	Collector-emitter saturation voltage	$V_{CE(sat)}$	$I_F=40\text{mA}, I_C=0.5\text{mA}$	—	—	0.4	V
	Response time (Rise)	$t_r$	$V_{CE}=2\text{V}, I_C=2\text{mA}$	—	3	15	$\mu\text{s}$
	Response time (Fall)	$t_f$	$R_L=100\Omega$	—	4	20	$\mu\text{s}$

Fig. 1 Forward Current vs. Ambient Temperature

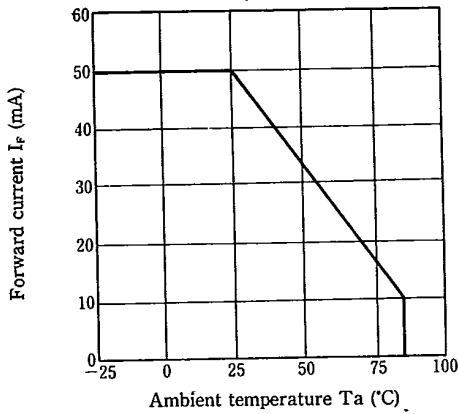

Fig. 2 Collector Power Dissipation vs. Ambient Temperature

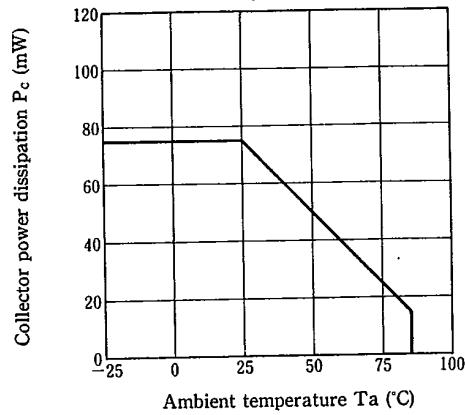

Fig. 3 Peak Forward Current vs. Duty Ratio

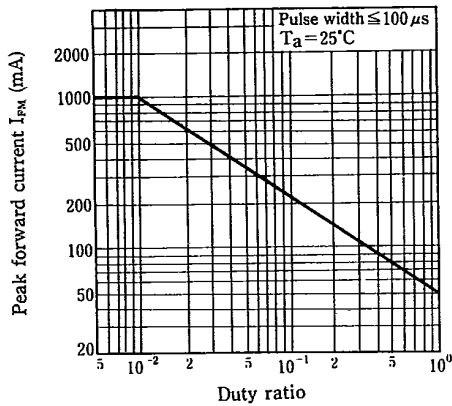
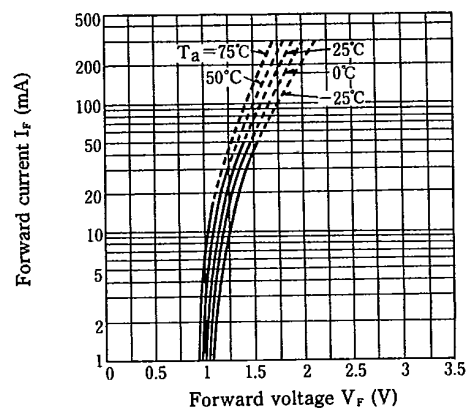

Fig. 4 Forward Current vs. Forward Voltage



T-41-73

Fig. 5 Collector Current vs. Forward Current

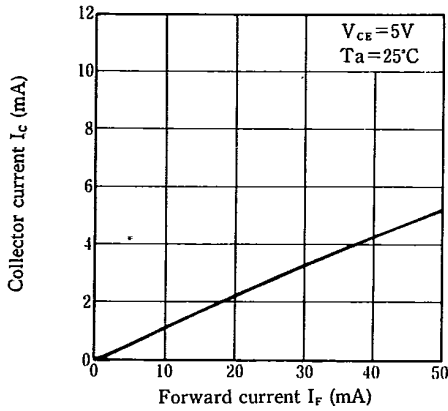

Fig. 6 Collector Current vs. Collector-emitter Voltage

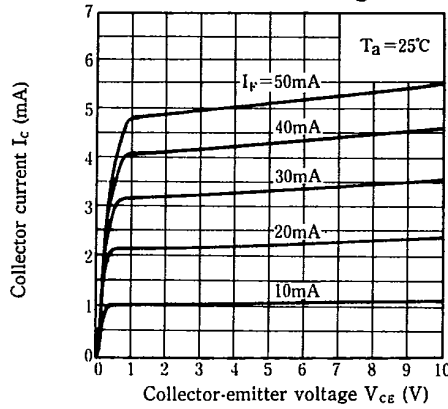

Fig. 7 Collector Current vs. Ambient Temperature

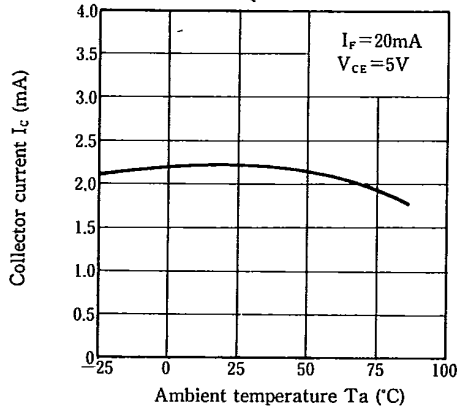

Fig. 8 Collector-emitter Saturation Voltage vs. Ambient Temperature

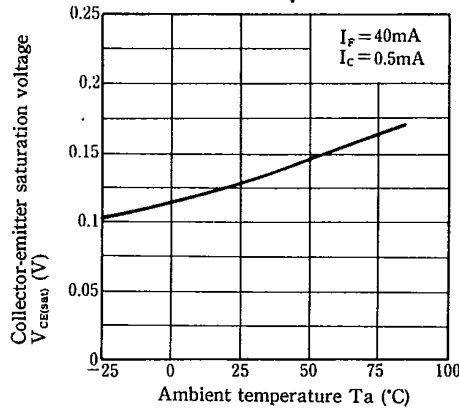
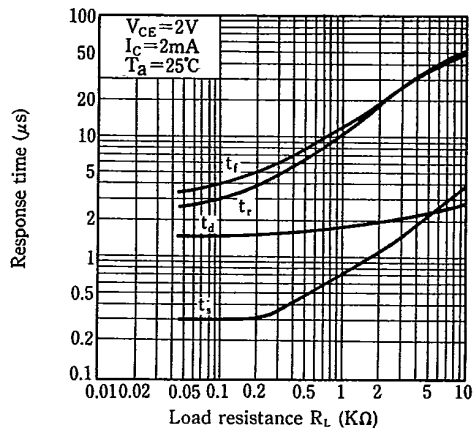
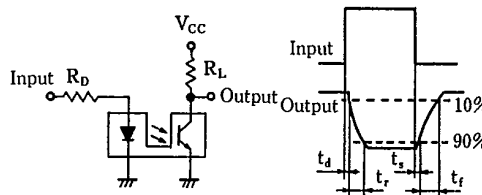

Fig. 9 Response Time vs. Load Resistance



Test Circuit for Response Time



T-41-73

Fig. 10 Frequency Response

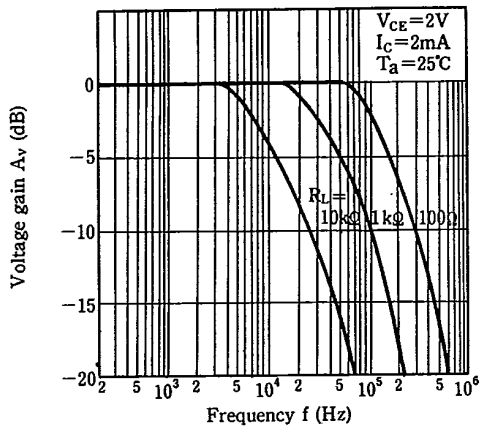

Fig. 11 Collector Dark Current vs. Ambient Temperature

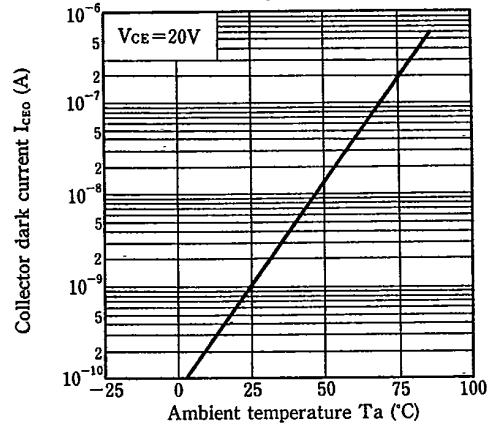

Fig. 12 Relative Collector Current vs. Shield Distance (1)

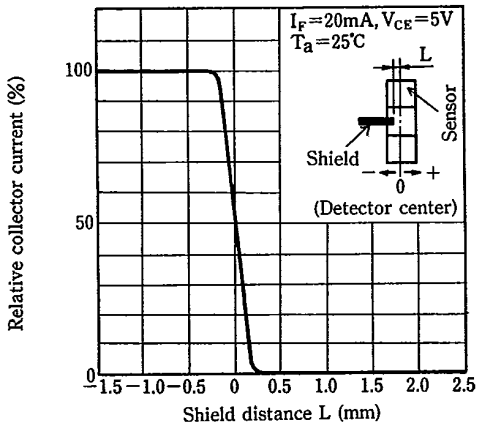

Fig. 13 Relative Collector Current vs. Shield Distance (2)

