

BGA  
Commercial Temp  
Industrial Temp

# 256K x 32 8Mb Asynchronous SRAM

10, 12, 15ns  
3.3V V<sub>DD</sub>

## Features

- Fast access time: 10, 12, 15ns.
- CMOS low power operation: 340/290/260/220mA at min. cycle time.
- Single 3.3V ± 0.3V power supply.
- All inputs and outputs are TTL compatible.
- Byte control.
- Fully static operation.
- Industrial Temperature Option: -40° to 85°C.
- 14mm x 22mm, 119 Bump, 1.27mm Pitch Ball Grid Array package.

## Description

The GS78132 is a high speed CMOS static RAM organized as 262,144-words by 32-bits. Static design eliminates the need for external clocks or timing strobes. Operating on a single 3.3V power supply and all inputs and outputs are TTL compatible. The GS78132 is available in 14mm x 22mm BGA package.

## Pin Descriptions

Symbol	Description
A <sub>0</sub> to A <sub>17</sub>	Address input
$\overline{CE}$	Chip enable input
DQA <sub>1</sub> TO DQA <sub>8</sub>	Byte A Data input/output
DQB <sub>1</sub> TO DQB <sub>8</sub>	Byte B Data input/output
DQC <sub>1</sub> TO DQC <sub>8</sub>	Byte C Data input/output
DQD <sub>1</sub> TO DQD <sub>8</sub>	Byte D Data input/output
$\overline{BA}$	Byte A Byte enable input
$\overline{BB}$	Byte B Byte enable input
$\overline{BC}$	Byte C Byte enable input
$\overline{BD}$	Byte D Byte enable input
$\overline{WE}$	Write enable input
$\overline{OE}$	Output enable input
V <sub>DD</sub>	+3.3V power supply
V <sub>SS</sub>	Ground
NC	No connect

## Block Diagram

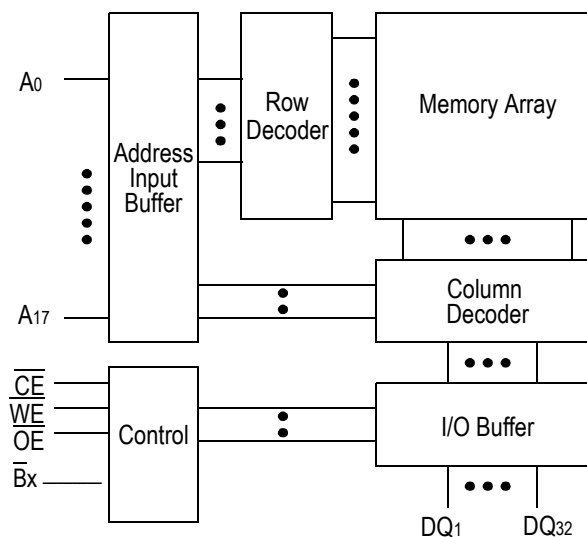

256K x 32 Async SRAM in 119 Bump, 14x22mmBGA

Top View

	1	2	3	4	5	6	7
A	NC	A15	A14	A16	A13	A12	NC
B	$\overline{B_C}$	A11	A10	$\overline{C_E}$	A9	A8	$\overline{B_B}$
C	DQC6	NC	V <sub>DD</sub> , NC	A17	V <sub>SS</sub> , NC	NC	DQB6
D	DQC5	V <sub>DD</sub>	V <sub>SS</sub>	V <sub>SS</sub>	V <sub>SS</sub>	V <sub>DD</sub>	DQB5
E	DQC4	DQC8	V <sub>DD</sub>	V <sub>SS</sub>	V <sub>DD</sub>	DQB8	DQB4
F	DQC3	V <sub>DD</sub>	V <sub>SS</sub>	V <sub>SS</sub>	V <sub>SS</sub>	V <sub>DD</sub>	DQB3
G	DQC2	DQC7	V <sub>DD</sub>	V <sub>SS</sub>	V <sub>DD</sub>	DQB7	DQB2
H	DQC1	V <sub>DD</sub>	V <sub>SS</sub>	V <sub>SS</sub>	V <sub>SS</sub>	V <sub>DD</sub>	DQB1
J	V <sub>DD</sub>	V <sub>SS</sub>	V <sub>DD</sub>	V <sub>SS</sub>	V <sub>DD</sub>	V <sub>SS</sub>	V <sub>DD</sub>
K	DQD1	V <sub>DD</sub>	V <sub>SS</sub>	V <sub>SS</sub>	V <sub>SS</sub>	V <sub>DD</sub>	DQA1
L	DQD2	DQD7	V <sub>DD</sub>	V <sub>SS</sub>	V <sub>DD</sub>	DQA7	DQA2
M	DQD3	V <sub>DD</sub>	V <sub>SS</sub>	V <sub>SS</sub>	V <sub>SS</sub>	V <sub>DD</sub>	DQA3
N	DQD4	DQD8	V <sub>DD</sub>	V <sub>SS</sub>	V <sub>DD</sub>	DQA8	DQA4
P	DQD5	V <sub>DD</sub>	V <sub>SS</sub>	V <sub>SS</sub>	V <sub>SS</sub>	V <sub>DD</sub>	DQA5
R	DQD6	NC	NC	NC	NC	NC	DQA6
T	$\overline{B_D}$	A7	A6	$\overline{W_E}$	A5	A4	$\overline{B_A}$
U	NC	A3	A2	$\overline{O_E}$	A1	A0	NC

Note: Bumps 3C and 5C are actually NC's but should be wired 3C = V<sub>DD</sub> and 5C = V<sub>SS</sub> to assure compatibility with future versions.

### Truth Table

$\overline{CE}$	$\overline{OE}$	$\overline{WE}$	$\overline{BA}$	$\overline{BB}$	$\overline{BC}$	$\overline{BD}$	DQA1-8	DQB1-8	DQC1-8	DQD1-8	Supply Current
H	X	X	X	X	X	X	Not Selected	Not Selected	Not Selected	Not Selected	ISB1, ISB2
L	L	H	L	L	L	L	Read	Read	Read	Read	IDD
			H	L	L	L	High Z	Read	Read	Read	
			L	H	L	L	Read	High Z	Read	Read	
			L	L	H	L	Read	Read	High Z	Read	
			L	L	L	H	Read	Read	Read	High Z	
L	X	L	L	L	L	L	Write	Write	Write	Write	
			H	L	L	L	High Z	Write	Write	Write	
			L	H	L	L	Write	High Z	Write	Write	
			L	L	H	L	Write	Write	High Z	Write	
			L	L	L	H	Write	Write	Write	High	
L	H	H	X	X	X	X	High Z	High Z	High Z	High Z	
L	X	X	H	H	H	H	High Z	High Z	High Z	High Z	

Note: X: "H" or "L"

### Absolute Maximum Ratings

Parameter	Symbol	Rating	Unit
Supply Voltage	$V_{DD}$	-0.5 to +4.6	V
Input Voltage	$V_{IN}$	-0.5 to $V_{DD}+0.5$ ( $\leq 4.6V$ max.)	V
Output Voltage	$V_{OUT}$	-0.5 to $V_{DD}+0.5$ ( $\leq 4.6V$ max.)	V
Allowable power dissipation	PD	1.5	W
Storage temperature	$T_{STG}$	-55 to 150	°C

Note:

Permanent device damage may occur if Absolute Maximum Ratings are exceeded. Functional operation shall be restricted to Recommended Operating Conditions. Exposure to higher than recommended voltages for extended periods of time could affect device reliability.

## Recommended Operating Conditions

Parameter	Symbol	Min	Typ	Max	Unit
Supply Voltage for -10/12/15	V <sub>DD</sub>	3.0	3.3	3.6	V
Input High Voltage	V <sub>IH</sub>	2.0	-	V <sub>DD</sub> +0.3	V
Input Low Voltage	V <sub>IL</sub>	-0.3	-	0.8	V
Ambient Temperature, Commercial Range	T <sub>Ac</sub>	0	-	70	°C
Ambient Temperature, Industrial Range	T <sub>Ai</sub>	-40	-	85	°C

Note:

1. Input overshoot voltage should be less than V<sub>DD</sub>+2V and not exceed 20ns.
2. Input undershoot voltage should be greater than -2V and not exceed 20ns.

## Capacitance

Parameter	Symbol	Test Condition	Max	Unit
Input Capacitance	C <sub>IN</sub>	V <sub>IN</sub> =0V	10	pF
Output Capacitance	C <sub>OUT</sub>	V <sub>OUT</sub> =0V	7	pF

Notes:

1. Tested at T<sub>A</sub>=25°C, f=1MHz
2. These parameters are sampled and are not 100% tested

## DC I/O Pin Characteristics

Parameter	Symbol	Test Conditions	Min	Max
Input Leakage Current	I <sub>IL</sub>	V <sub>IN</sub> = 0 to V <sub>DD</sub>	-2uA	2uA
Output Leakage Current	I <sub>OL</sub>	Output High Z, V <sub>OUT</sub> = 0 to V <sub>DD</sub>	-1uA	1uA
Output High Voltage	V <sub>OH</sub>	I <sub>OH</sub> = - 4mA	2.4	
Output Low Voltage	V <sub>OL</sub>	I <sub>OL</sub> = + 4mA		0.4V

## Power Supply Currents

Parameter	Symbol	Test Conditions	0 to 70°C			-40 to 85°C		
			10ns	12ns	15ns	10ns	12ns	15ns
Operating Supply Current	$I_{DD}$	$\bar{E} \leq V_{IL}$ All other inputs $\geq V_{IH}$ or $\leq V_{IL}$ Min. cycle time $I_{OUT} = 0$ mA	290mA	260mA	220mA	310mA	280mA	240mA
Standby Current	$I_{SB1}$	$\bar{E} \geq V_{IH}$ All other inputs $\geq V_{IH}$ or $\leq V_{IL}$ Min. cycle time	130mA	120mA	110mA	150mA	140mA	130mA
Standby Current	$I_{SB2}$	$E \geq V_{DD} - 0.2V$ All other inputs $\geq V_{DD} - 0.2V$ or $\leq 0.2V$	60mA			80mA		

## AC Test Conditions

Parameter	Conditions
Input high level	$V_{IH}=2.4V$
Input low level	$V_{IL}=0.4V$
Input rise time	$t_r=1V/ns$
Input fall time	$t_f=1V/ns$
Input reference level	1.4V
Output reference level	1.4V
Output load	Fig. 1 & 2

Note:

1. Include scope and jig capacitance.
2. Test conditions as specified with output loading as shown in Fig. 1 unless otherwise noted
3. Output load 2 for  $t_{LZ}$ ,  $t_{HZ}$ ,  $t_{OLZ}$  and  $t_{OHZ}$ .

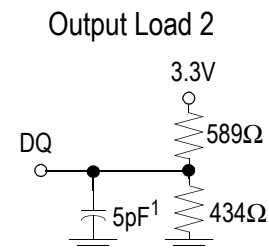
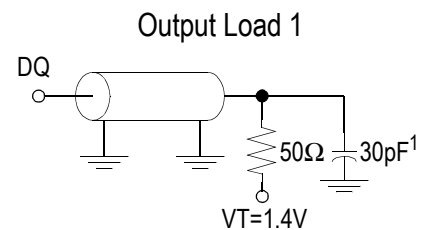

## AC Characteristics

### Read Cycle

Parameter	Symbol	-10		-12		-15		Unit
		Min	Max	Min	Max	Min	Max	
Read cycle time	$t_{RC}$	10	---	12	---	15	---	ns
Address access time	$t_{AA}$	---	10	---	12	---	15	ns
Chip enable access time ( $\overline{CE}$ )	$t_{AC}$	---	10	---	12	---	15	ns
Byte enable access time	$t_{AB}$	---	4	---	5	---	6	ns
Output enable to output valid ( $\overline{OE}$ )	$t_{OE}$	---	4	---	5	---	6	ns
Output hold from address change	$t_{OH}$	3	---	3	---	3	---	ns
Chip enable to output in low Z ( $\overline{CE}$ )	$t_{LZ}^*$	3	---	3	---	3	---	ns
Output enable to output in low Z ( $\overline{OE}$ )	$t_{OLZ}^*$	0	---	0	---	0	---	ns
Byte enable to output in low Z	$t_{BLZ}^*$	0	---	0	---	0	---	ns
Chip disable to output in High Z ( $\overline{CE}$ )	$t_{HZ}^*$	---	5	---	6	---	7	ns
Output disable to output in High Z ( $\overline{OE}$ )	$t_{OHZ}^*$	---	4	---	5	---	6	ns
Byte disable to output in High Z	$t_{BHZ}^*$	---	4	---	5	---	6	ns

Read Cycle 1:  $\overline{CE} = \overline{OE} = V_{IL}$ ,  $\overline{WE} = V_{IH}$ ,  $\overline{BA} = \overline{BB} = \overline{BC} = \overline{BD} = V_{IL}$

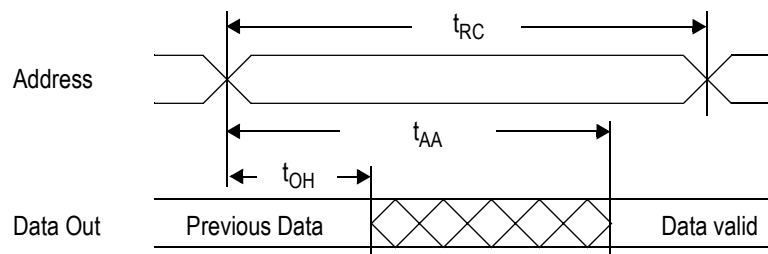

Read Cycle 2:  $\overline{WE} = V_{IH}$

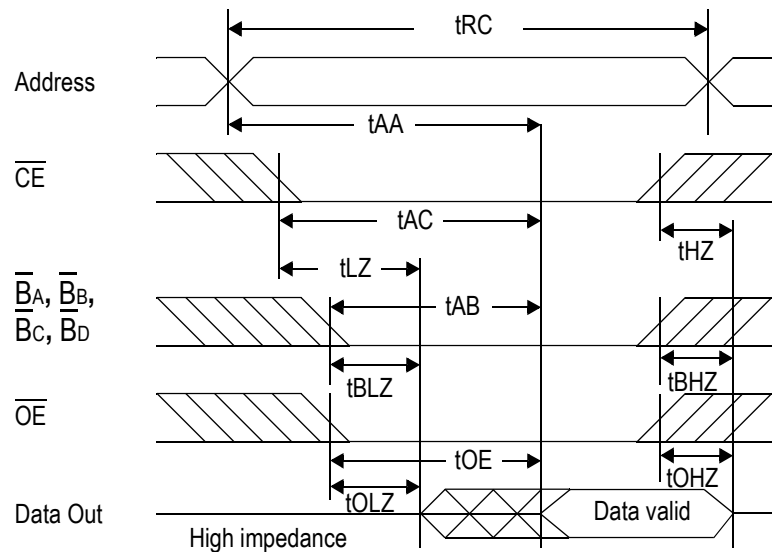

Write Cycle

Parameter	Symbol	-10		-12		-15		Unit
		Min	Max	Min	Max	Min	Max	
Write cycle time	$t_{WC}$	10	---	12	---	15	---	ns
Address valid to end of write	$t_{AW}$	7	---	8	---	10	---	ns
Chip enable to end of write	$t_{CW}$	7	---	8	---	10	---	ns
Byte enable to end of write	$t_{BW}$	7	---	8	---	10	---	ns
Data set up time	$t_{DW}$	5	---	6	---	7	---	ns
Data hold time	$t_{DH}$	0	---	0	---	0	---	ns
Write pulse width	$t_{WP}$	7	---	8	---	10	---	ns
Address set up time	$t_{AS}$	0	---	0	---	0	---	ns
Write recovery time ( $\overline{WE}$ )	$t_{WR}$	0	---	0	---	0	---	ns
Write recovery time ( $\overline{CE}$ )	$t_{WR1}$	0	---	0	---	0	---	ns
Output Low Z from end of write	$t_{WLZ}^*$	3	---	3	---	3	---	ns
Write to output in High Z	$t_{WHZ}^*$	---	4	---	5	---	6	ns

\* These parameters are sampled and are not 100% tested

Write Cycle 1:  $\overline{\text{WE}}$  Controlled

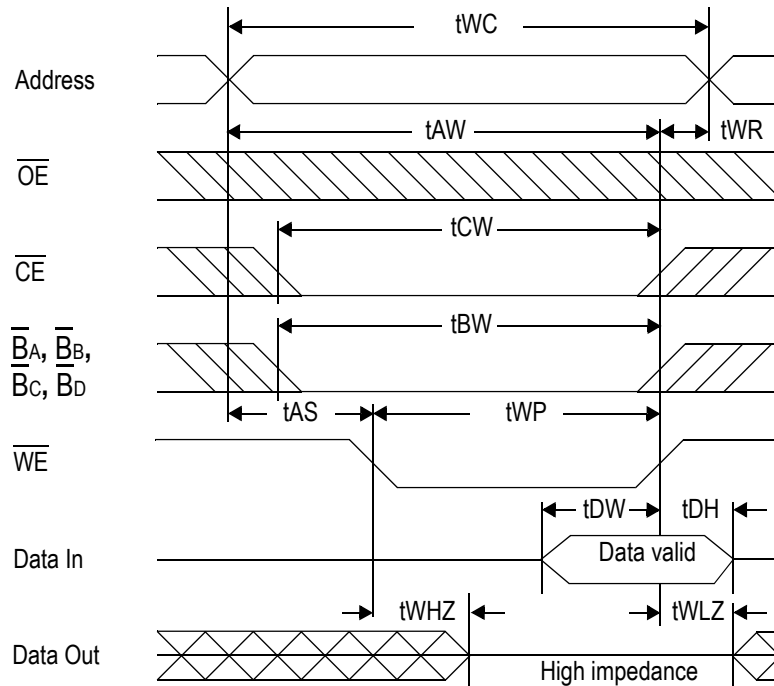

Write Cycle 2:  $\overline{\text{CE}}$  Controlled

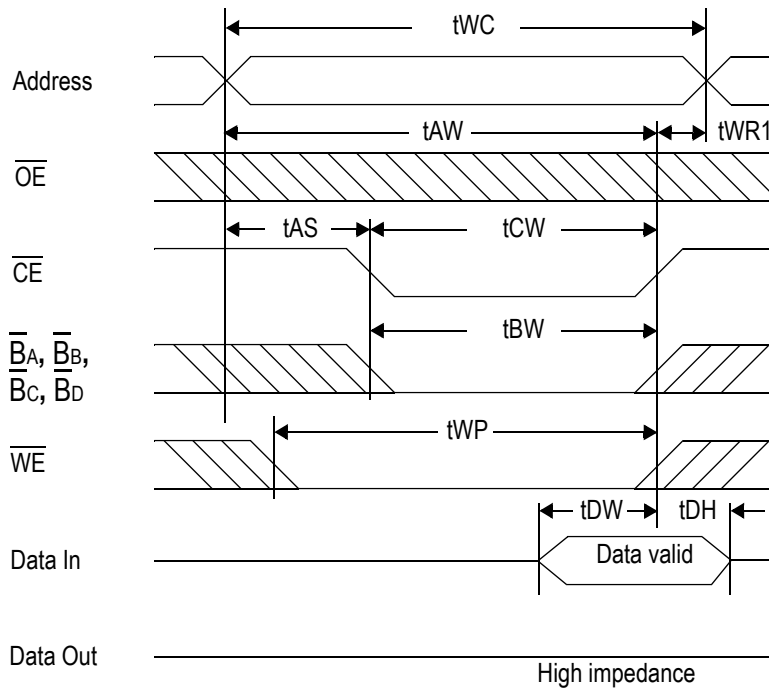



Write Cycle 3: Byte Enable Controlled

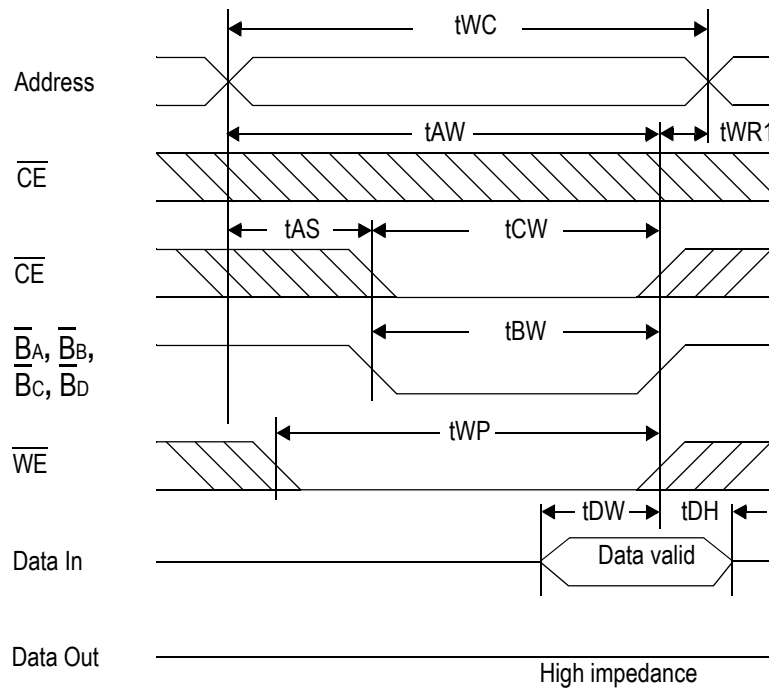

### Package Dimensions - 119 Pin PBGA

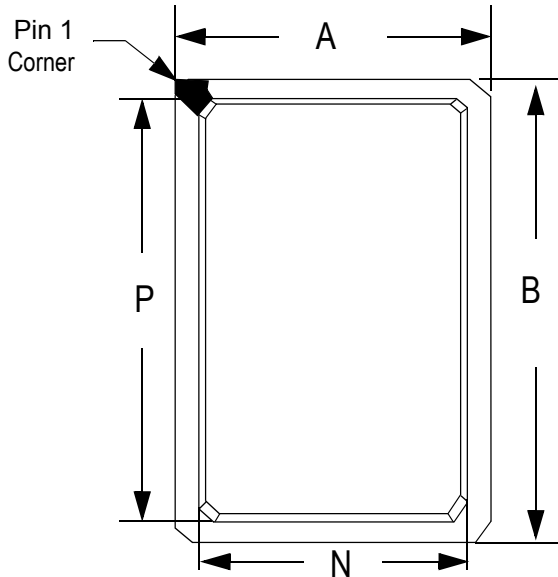

Top View

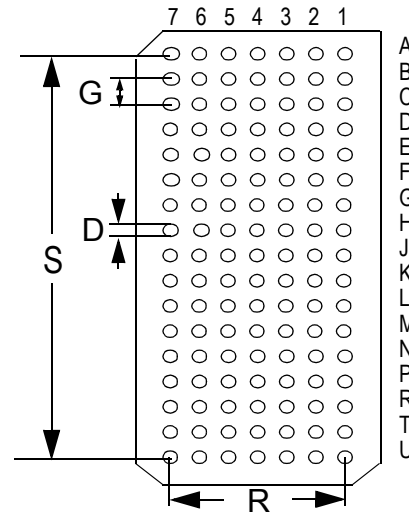

Bottom View

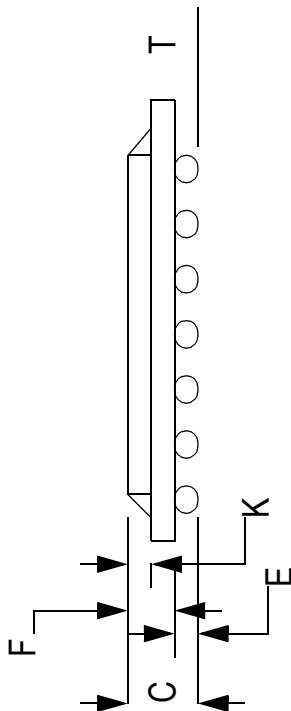

Side View

### Package Dimensions - 119 Pin PBGA

Symbol	Description	Min.	Nom.	Max
A	Width	13.8	14.0	14.2
B	Length	21.8	22.0	22.2
C	Package Height (including ball)	-		2.40
D	Ball Size	0.60	0.75	0.90
E	Ball Height	0.50	0.60	0.70
F	Package Height (excluding balls)		1.46	1.70
G	Width between Balls		1.27	
K	Package Height above board	0.80	0.90	1.00
N	Cut-out Package Width		12.00	
P	Foot Length		19.50	
R	Width of package between balls		7.62	
S	Length of package between balls		20.32	
T	Variance of Ball Height		0.15	

Unit: mm

### Ordering Information

Part Number *	Package	Access Time	Temp. Range	Status
GS78132B-10	BGA	10 ns	Commercial	
GS78132B-12	BGA	12 ns	Commercial	
GS78132B-15	BGA	15 ns	Commercial	
GS78132B-10I	BGA	10 ns	Industrial	
GS78132B-12I	BGA	12 ns	Industrial	
GS78132B-15I	BGA	15 ns	Industrial	

\* Customers requiring delivery in Tape and Reel should add the character "T" to the end of the part number. For example: GS78132B-12T

### Revision History

Rev. Code: Old; New	Types of Changes Format or Content	Page #/Revisions/Reason
GS78132Rev0.01a 5/1999; 1.00 X/1999	Format/Typos	<ul style="list-style-type: none"> <li>• p.2/Changed 12x22 to 14x22/Typo</li> <li>• p.2/Changed <math>\bar{E}</math> to <math>\bar{CE}</math>/consistency.</li> </ul>
	Content	<ul style="list-style-type: none"> <li>• p.2/Changed Pin T1 from <math>\bar{B}A</math> to <math>\bar{B}b</math>/Correction</li> </ul>
GS78132Rev 1.0010/1999A;Rev 1.01 2/2000FormatB		<ul style="list-style-type: none"> <li>• Added GSI Logo</li> </ul>