

HA13403, HA13403V, HA13403MP

Three-Phase Brushless Motor Driver

Description

The HA13403 is a monolithic power IC developed for use as a three-phase brushless DC motor driver.

With a maximum output current of 1.5 A/phase and power supply voltage of 26 V, this device is ideal as a driver for VTR cylinder or capstan motors.

Features

- High output current and low output saturation voltage
- Separate power supplies for the control and output blocks permit each to be used over a wide range of voltages

	HA13403/V	HA13403MP
Control block	4.5 to 13 V	4.5 to 5.5 V
Output block	V _{CC1} to 24 V	V _{CC1} to 15 V

- Includes FG amplifier
- Includes brake circuit

Ordering Information

Type No.	Package
HA13403	SP-23TA
HA13403V	SP-23TB
HA13403MP	MP-28

Pin Assignment

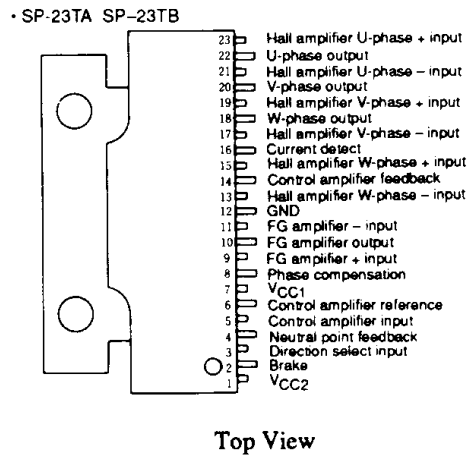
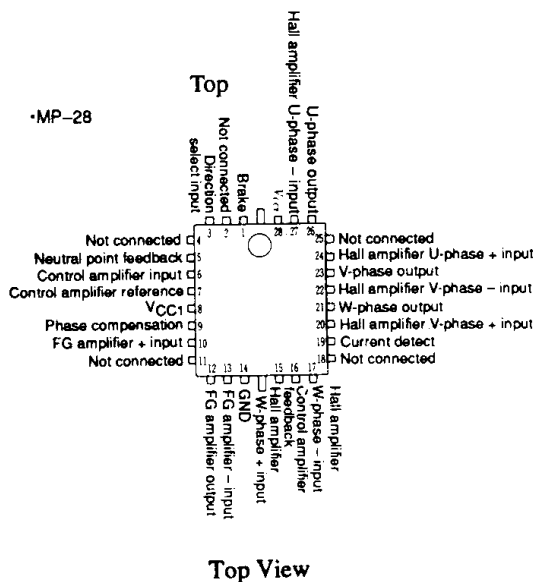

• HA13403

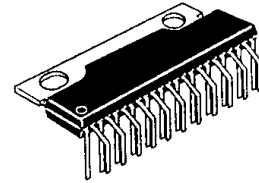

(SP-23TA)

• HA13403V

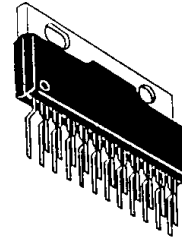

(SP-23TB)

• HA13403MP

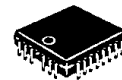

(MP-28)

HA13403, HA13403V, HA13403MP

Block Diagram

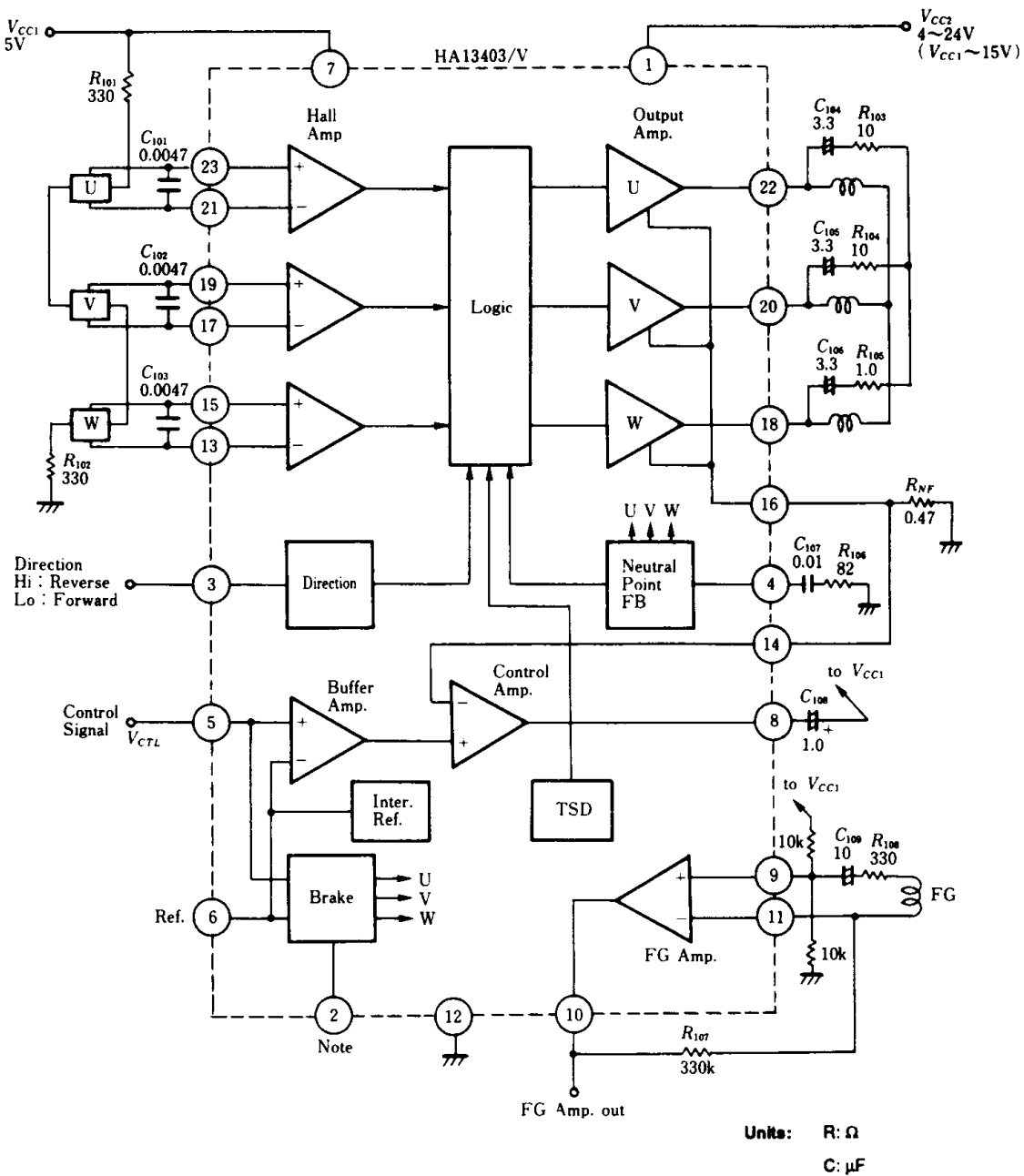

Note: The brake circuit is disabled if pins 1 and 2 are shorted.



HA13403, HA13403V, HA13403MP

Absolute Maximum Ratings (Ta = 25°C)

Parameter	Symbol	Rating		Unit
		HA13403/V	HA13403MP	
Control block power supply voltage	V _{CC1}	13	13	V
Output block power supply voltage	V _{CC2}	26	20	V
Output current	I _O	1.5	1.0	A
Hall amplifier input voltage	V _H	0 to V _{CC1}	0 to V _{CC1}	V
Direction select input voltage	V _D	0 to V _{CC1}	0 to V _{CC1}	V
Control input voltage	V _{CTL}	0 to V _{CC1}	0 to V _{CC1}	V
Power dissipation	P _T	10	1.0	W
Junction temperature	T _j	150	150	°C
Operating temperature	T _{opr}	-20 to +70	-20 to +70	°C
Storage temperature	T _{stg}	-55 to +125	-55 to +125	°C

The absolute maximum ratings are limiting values, to be applied individually, beyond which the device may be permanently damaged. Functional operation under any of these conditions is not guaranteed. Exposing a circuit to its absolute maximum rating for extended periods of time may affect the device's reliability.

Note:

1. Depends on derating. Thermal resistance is as follows:

Junction—TAB $\theta_{jc} \leq 5^\circ\text{C/W}$ (HA13403/V)

Junction—air $\theta_{ja} \leq 40^\circ\text{C/W}$ (HA13403/V)

Junction—air $\theta_{ja} \leq 80^\circ\text{C/W}$ (HA13403MP mounted on an aluminum baseplate)

Electrical Characteristics (V_{CC1} = 5 V, V_{CC2} = 15 V, Ta = 25°C)

Parameter	Symbol	Min	Typ	Max	Unit	Test Conditions	Pin		Notes
							SP-23TA	MP-28	
Quiescent current	I _{CC1}	6	8	7	mA	V _{CTL} = V _{CC1} /2	V _{CC1} = 5 V	7	12
		9	12.4	20	mA		V _{CC1} = 12 V		
	I _{CC2}	3.1	4.2	6.5	mA	V _{CTL} = V _{CC1}		1	28
TSD operating temperature	T _{sd}	125	—	—	°C				
Hall amplifier input current	I _{BH}	—	1.3	10	μA	V _H = V _{CC1}		13, 15	15, 17
Hall amplifier common mode input voltage	V _H	1.5	—	3.5	V		V _{CC1} = 5 V	17, 19	20, 22
		2	—	9	V		V _{CC2} = 12 V	21, 23	24, 27
Logic sensitivity	U _w	—	—	±10	mV	I _O = 50 mA			1
Output TRS breakdown voltage	BV _{CER}	26	—	—	V	I _C = 50 mA		18	21
Output amplifier leakage current	I _{CER}	—	—	1.0	mA	V _{CE} = 20 V		20	23
Output saturation voltage	V _{CE (Sat)}	—	2.1	2.8	V	V _{CTL} = V _{CC1}	I _O = 1 A	22	26
		—	3.3	4.7	V		I _O = 1.5 A		
		—	1.1	1.5	V		I _O = 0.3 A,		
		—	—	1.2	V	V _{CTL} = V _{CC1} , I _O = 1 A			
Reference voltage	V _{REF}	2.25	2.5	2.75	V		V _{CC1} = 5 V	6	7
		5.4	6.0	6.6	V		V _{CC1} = 12 V		
Threshold voltage	V _{TH}	0.08	0.14	0.27	V	I _O = 20 mA	V _{CC1} = 5 V	5	6
		0.09	0.17	0.31	V		V _{CC1} = 12 V		
Control input current	I _{CTL}	—	10	30	μA	V _{CTL} = V _{CC1}	V _{CC1} = 5 V		
		—	80	240	μA		V _{CC1} = 12 V		
		—	—	15	μA	V _{CTL} = V _{CC}	V _{CC1} = 12 V		
		-15	—	—	μA	V _{CTL} = 0 V	V _{CC1} = 12 V		



HA13403, HA13403V, HA13403MP

Parameter	Symbol	Min	Typ	Max	Unit	Test Conditions	Pin		Notes
							SP-23TA	MP-28	
Control amplifier voltage gain	G_{CTL}	-8	-6	-4	dB	$I_O = 50 \text{ mA}$	16	19	
		-9.7	-7.7	-5.7	dB	$I_O = 200 \text{ mA}$			
Forward mode voltage range	V_{D-F}	0	—	1.5	V	$V_{CC1} = 5 \text{ V}$	3	3	
		0	—	2.2	V	$V_{CC1} = 12 \text{ V}$			
Reverse mode voltage range	V_{D-R}	3.5	—	5	V	$V_{CC1} = 5 \text{ V}$	3	3	
		4.2	—	12	V	$V_{CC1} = 12 \text{ V}$			
Forward mode input current	V_{D-F}	-0.28	-0.18	-0.12	mA	$V_D = 0 \text{ V}$	3	3	
		-0.40	-0.25	-0.16	mA	$V_{CC1} = 12 \text{ V}$			
Reverse mode input current	V_{D-R}	0.12	0.18	0.28	mA	$V_D = V_{CC1}$			
		0.4	0.9	1.4	mA	$V_{CC1} = 12 \text{ V}$			
Brake mode voltage	V_{BRK}	1.0	—	1.5	V	$V_{CC1} = 5 \text{ V}$	5	6	5
		1.0	—	5	V	$V_{CC1} = 12 \text{ V}$			
Brake release voltage		—	—	0.5	V				
FG amplifier output bias current		-0.5	-0.25	-0.12	mA	$V_{CC1} = 5 \text{ V}$	10	12	
		-0.8	-0.4	-0.2	mA	$V_{CC1} = 12 \text{ V}$			
FG amplifier output voltage		2.3	2.8	3.5	V				

Notes:

1. Minimum input voltage necessary for 80% or more of $I_O = 50 \text{ mA}$ to flow at original phase.
2. Sum of the upper and lower saturation voltages.
3. Lower saturation voltage when brake circuit is in operation.
4. Difference in voltage from pin 6.
5. See figure 1.
6. Values in parentheses are for the HA13403MP.

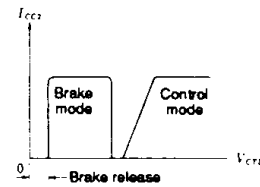

Figure 1

Timing Chart

