

# HD74LS221 • Dual Monostable Multivibrators

This multivibrator features a negative-transition-triggered input and a positive-transition-triggered input either of which can be used as an inhibit input. Pulse triggering occurs at a particular voltage level and is not directly related to the transition time of the input pulse. Schmitt-trigger input circuitry (TTL hysteresis) for B input allows jitter-free triggering from inputs with transition rates as slow as 1V/s, providing the circuit with excellent noise immunity of typically 1.2V. A high immunity to  $V_{CC}$  noise of typically 1.5V is also provided by internal latching circuitry. Once fired, the outputs are independent of further transitions of the A and B inputs and are a function of the timing components, or the output pulses can be terminated by the overriding clear. Input pulses may be of any duration relative to the output pulse. Output rise and fall times are TTL compatible and independent of pulse length.

Typical triggering and clearing sequence are illustrated as a part of the switching characteristics waveforms. Pulse width stability is achieved through internal compensation and is virtually independent of  $V_{CC}$  and temperature.

In most applications, pulse stability will only be limited by the accuracy of external timing components. Jitter-free operation is maintained over the full temperature and  $V_{CC}$  range for more than six decades of timing capacitance (10pF to 10 $\mu$ F) and more than one decade of timing resistance (2k $\Omega$  to 100k $\Omega$ ).

Throughout these ranges, pulse width is defined by the relationship:  $t_w(out) = C_{ext} \cdot R_{ext} \cdot 1n_2$ .

## FUNCTION TABLE

Inputs			Outputs	
Clear	A	B	Q	$\bar{Q}$
L	X	X	L	H
X	H	X	L	H
X	X	L	L	H
H	L	$\uparrow$	$\square$	$\square$
H	$\downarrow$	H	$\square$	$\square$
$\uparrow$	L	H	$\square$	$\square$

H; high level, L; low level, X; irrelevant.  
 $\downarrow$ ; Transition from high to low level.

$\uparrow$ ; Transition from low to high level.  
 $\square$ ; one high-level pulse.  
 $\square$ ; one low-level pulse.

## RECOMMENDED OPERATING CONDITIONS

Item	Symbol	min	typ	max	Unit
Rate of rise or fall of input pulse	Schmitt input, B	1	—	—	V/s
	logic input, A	1	—	—	V/ $\mu$ s
Input pulse width	A or B	40	—	—	ns
	Clear	40	—	—	ns
Setup time	$t_{su}$	15	—	—	ns
External timing resistance	$R_{ext}$	1.4	—	100	k $\Omega$
External timing capacitance	$C_{ext}$	0	—	1,000	$\mu$ F
Duty cycle	$R_T = 2k\Omega$	—	—	50	%
	$R_T = 100k\Omega$	—	—	90	%

## PIN ARRANGEMENT

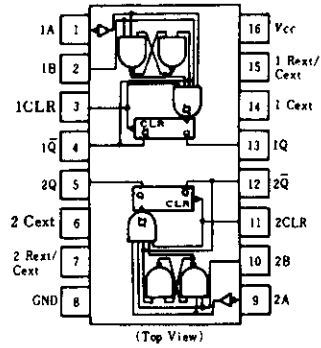

## BLOCK DIAGRAM (1/2)

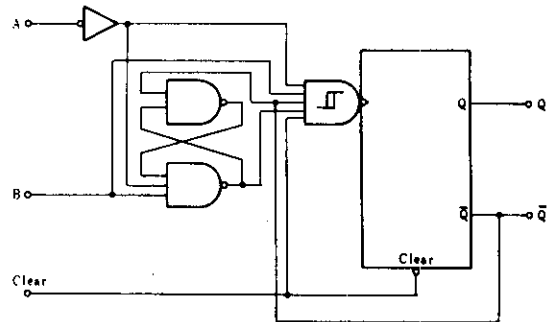

# HD74LS221

## ■ ELECTRICAL CHARACTERISTICS ( $T_a = -20 \sim +75^\circ\text{C}$ )

Item	Symbol	Test Conditions	min	typ*	max	Unit
Threshold voltage	A	$V_T^+$ $V_{CC}=4.75\text{V}$	—	1.0	2.0	V
		$V_T^-$ $V_{CC}=4.75\text{V}$	0.8	1.0	—	V
	B	$V_T^+$ $V_{CC}=4.75\text{V}$	—	1.0	2.0	V
		$V_T^-$ $V_{CC}=4.75\text{V}$	0.8	0.9	—	V
Output voltage	$V_{OH}$ $V_{CC}=4.75\text{V}$ , $I_{OH} = -400\mu\text{A}$	2.7	—	—	V	
	$V_{OL}$ $V_{CC}=4.75\text{V}$	$I_{OL} = 4\text{mA}$	—	—	0.4	V
		$I_{OL} = 8\text{mA}$	—	—	0.5	
Input current	A	$I_{IH}$ $V_{CC}=5.25\text{V}$ , $V_I=2.7\text{V}$	—	—	20	$\mu\text{A}$
		$I_{IL}$ $V_{CC}=5.25\text{V}$ , $V_I=0.4\text{V}$	—	—	-0.4	mA
	B, Clear	$I_I$ $V_{CC}=5.25\text{V}$ , $V_I=7\text{V}$	—	—	0.1	
		$I_{OS}$ $V_{CC}=5.25\text{V}$	-20	—	-100	mA
Supply current	$I_{CC}$ $V_{CC}=5.25\text{V}$	Quiescent	—	4.7	11	
		Triggered	—	19	27	
Input clamp voltage	$V_{IK}$ $V_{CC}=4.75\text{V}$ , $I_{IK} = -18\text{mA}$	—	—	-1.5	V	

\*  $V_{CC}=5\text{V}$ ,  $T_a=25^\circ\text{C}$

## ■ SWITCHING CHARACTERISTICS ( $V_{CC}=5\text{V}$ , $T_a=25^\circ\text{C}$ )

Item	Symbol	Inputs	Outputs	Test Conditions	min	typ	max	Unit	
Propagation delay time	$t_{PLH}$	A	Q	$C_L = 15\text{pF}$ $R_L = 2\text{k}\Omega$	—	45	70	ns	
		B	Q		—	35	55		
	$t_{PHL}$	A	$\bar{Q}$		$C_{ext} = 80\text{pF}$ $R_{ext} = 2\text{k}\Omega$	—	50	80	ns
		B	$\bar{Q}$			—	40	65	
	$t_{PHL}$	Clear	Q			—	35	55	ns
		$t_{PLH}$	Clear			$\bar{Q}$	—	44	
Output pulse width	$t_{\text{level}}$ A or B	Q or $\bar{Q}$		$C_{ext} = 80\text{pF}$ , $R_{ext} = 2\text{k}\Omega$		70	120	150	ns
				$C_{ext} = 0$ , $R_{ext} = 2\text{k}\Omega$		20	47	70	
				$C_{ext} = 100\text{pF}$ , $R_{ext} = 10\text{k}\Omega$	600	670	750		
				$C_{ext} = 1\mu\text{F}$ , $R_{ext} = 10\text{k}\Omega$	6	6.7	7.5	ms	

## ■ TESTING METHOD

### 1) Test Circuit

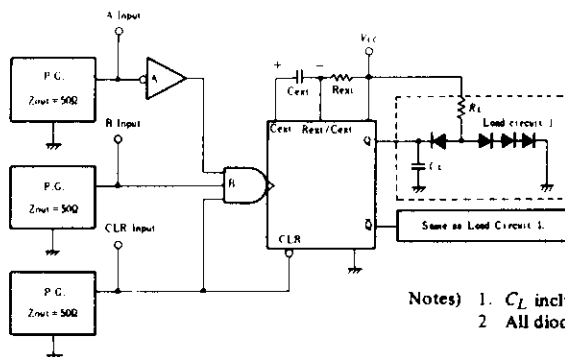

- Notes) 1.  $C_L$  includes probe and jig capacitance.  
2. All diodes are 1S2074 (H).

## Waveform

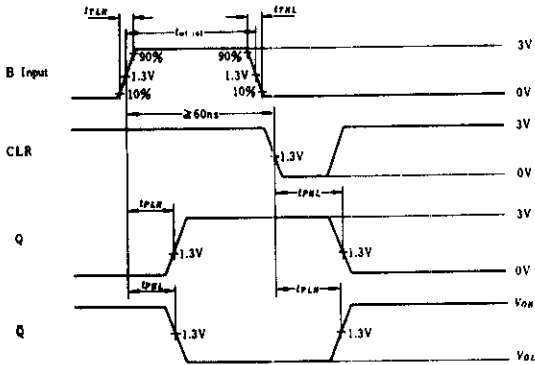

Trigger from B, then clear (A input is low).

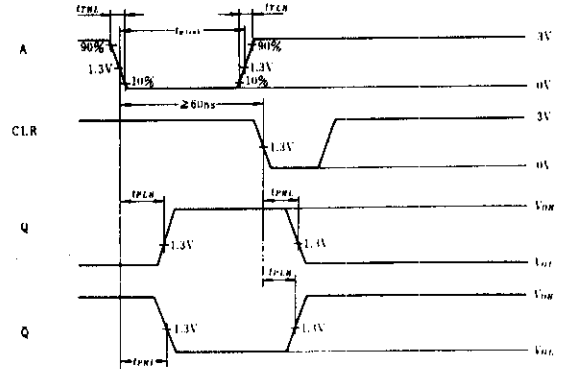

Trigger from A, then clear (B input is high).

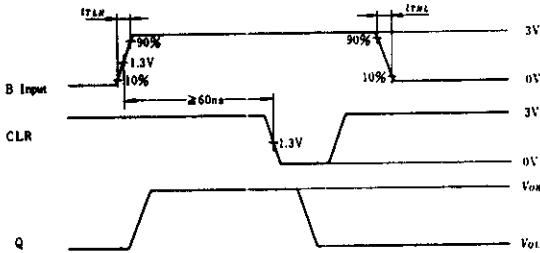

Trigger from B, then clear (A input is low).

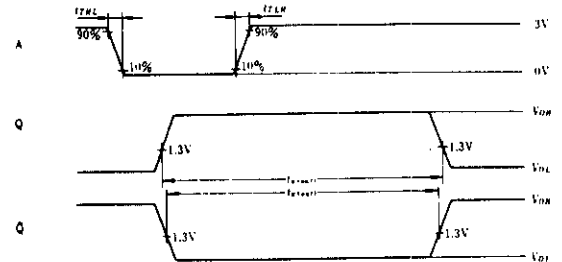

Trigger from A (B and clear inputs are high).

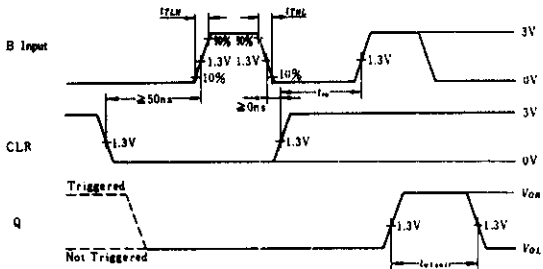

Clear overriding B, then trigger from B.

Note) Input pulse:  $t_{TLH} \leq 15\text{ns}$ ,  $t_{THL} \leq 6\text{ns}$ ,  $PRR = 1\text{MHz}$

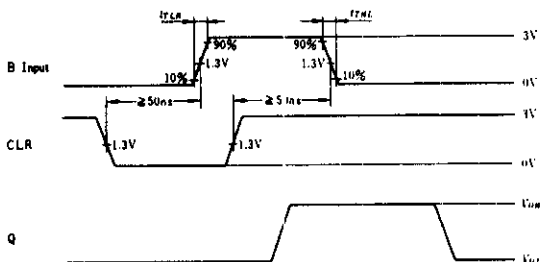

Triggering from positive transition of Clear.



Hitachi Code	DP-16
JEDEC	Conforms
EIAJ	Conforms
Weight (reference value)	1.07 g

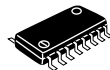

\*Dimension including the plating thickness  
Base material dimension

Hitachi Code	FP-16DA
JEDEC	—
EIAJ	Conforms
Weight (reference value)	0.24 g



\*Dimension including the plating thickness  
Base material dimension

Hitachi Code	FP-16DN
JEDEC	Conforms
EIAJ	Conforms
Weight (reference value)	0.15 g

## Cautions

1. Hitachi neither warrants nor grants licenses of any rights of Hitachi's or any third party's patent, copyright, trademark, or other intellectual property rights for information contained in this document. Hitachi bears no responsibility for problems that may arise with third party's rights, including intellectual property rights, in connection with use of the information contained in this document.
2. Products and product specifications may be subject to change without notice. Confirm that you have received the latest product standards or specifications before final design, purchase or use.
3. Hitachi makes every attempt to ensure that its products are of high quality and reliability. However, contact Hitachi's sales office before using the product in an application that demands especially high quality and reliability or where its failure or malfunction may directly threaten human life or cause risk of bodily injury, such as aerospace, aeronautics, nuclear power, combustion control, transportation, traffic, safety equipment or medical equipment for life support.
4. Design your application so that the product is used within the ranges guaranteed by Hitachi particularly for maximum rating, operating supply voltage range, heat radiation characteristics, installation conditions and other characteristics. Hitachi bears no responsibility for failure or damage when used beyond the guaranteed ranges. Even within the guaranteed ranges, consider normally foreseeable failure rates or failure modes in semiconductor devices and employ systemic measures such as fail-safes, so that the equipment incorporating Hitachi product does not cause bodily injury, fire or other consequential damage due to operation of the Hitachi product.
5. This product is not designed to be radiation resistant.
6. No one is permitted to reproduce or duplicate, in any form, the whole or part of this document without written approval from Hitachi.
7. Contact Hitachi's sales office for any questions regarding this document or Hitachi semiconductor products.

# HITACHI

## Hitachi, Ltd.

Semiconductor & Integrated Circuits.  
Nippon Bldg., 2-6-2, Ohte-machi, Chiyoda-ku, Tokyo 100-0004, Japan  
Tel: Tokyo (03) 3270-2111 Fax: (03) 3270-5109

URL      North America      : <http://semiconductor.hitachi.com/>  
             Europe                 : <http://www.hitachi-eu.com/hel/ecg>  
             Asia (Singapore)       : <http://www.has.hitachi.com.sg/grp3/sicd/index.htm>  
             Asia (Taiwan)            : [http://www.hitachi.com.tw/E/Product/SICD\\_Frame.htm](http://www.hitachi.com.tw/E/Product/SICD_Frame.htm)  
             Asia (HongKong)        : <http://www.hitachi.com.hk/eng/bo/grp3/index.htm>  
             Japan                        : <http://www.hitachi.co.jp/Sicd/indx.htm>

## For further information write to:

Hitachi Semiconductor  
(America) Inc.  
179 East Tasman Drive,  
San Jose, CA 95134  
Tel: <1> (408) 433-1990  
Fax: <1> (408) 433-0223

Hitachi Europe GmbH  
Electronic components Group  
Dornacher Straße 3  
D-85622 Feldkirchen, Munich  
Germany  
Tel: <49> (89) 9 9180-0  
Fax: <49> (89) 9 29 30 00

Hitachi Europe Ltd.  
Electronic Components Group.  
Whitebrook Park  
Lower Cookham Road  
Maidenhead  
Berkshire SL6 8YA, United Kingdom  
Tel: <44> (1628) 585000  
Fax: <44> (1628) 778322

Hitachi Asia Pte. Ltd.  
16 Collyer Quay #20-00  
Hitachi Tower  
Singapore 049318  
Tel: 535-2100  
Fax: 535-1533

Hitachi Asia Ltd.  
Taipei Branch Office  
3F, Hung Kuo Building, No.167,  
Tun-Hwa North Road, Taipei (105)  
Tel: <886> (2) 2718-3666  
Fax: <886> (2) 2718-8180

Hitachi Asia (Hong Kong) Ltd.  
Group III (Electronic Components)  
7/F., North Tower, World Finance Centre,  
Harbour City, Canton Road, Tsim Sha Tsui,  
Kowloon, Hong Kong  
Tel: <852> (2) 735 9218  
Fax: <852> (2) 730 0281  
Telex: 40815 HITEC HX

Copyright ' Hitachi, Ltd., 1999. All rights reserved. Printed in Japan.

**HITACHI**