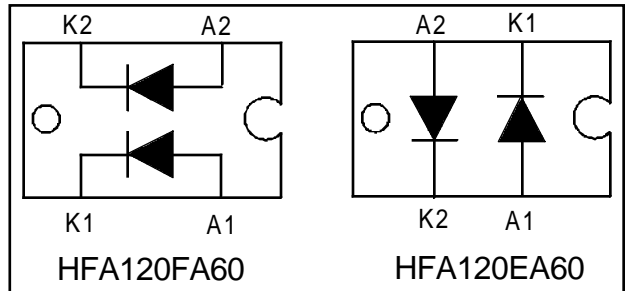


$V_R = 600V$
$V_F(\text{typ.})^* = 1.4V$
$I_{F(AV)} = 60A$
$Q_{rr}(\text{typ.}) = 270nC$
$I_{RRM}(\text{typ.}) = 7.0A$
$t_{rr}(\text{typ.}) = 65ns$
$di_{(rec)M}/dt(\text{typ.})^* = 270A/\mu s$



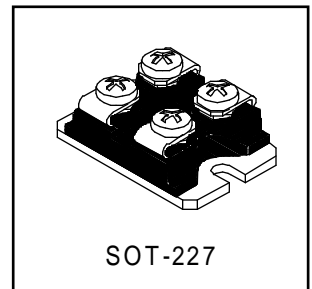
### Features

- Fast Recovery time characteristic
- Electrically isolated base plate
- Large creepage distance between terminal
- Simplified mechanical designs, rapid assembly

### Description

This SOT-227 modules with FRED rectifier are available in two basic configurations. They are the antiparallel and the parallel configurations. The antiparallel configuration (HFA120EA60) is used for simple series rectifier and high voltage application. The parallel configuration (HFA120FA60) is used for simple parallel rectifier and high current application. The semiconductor in the SOT-227 package is isolated from the copper base plate, allowing for common heatsinks and compact assemblies to be built.

These modules are intended for general applications such as power supplies, battery chargers, electronic welders, motor control, DC chopper, and inverters.



### Absolute Maximum Ratings (per Leg)

	Parameter	Max.	Units
$V_R$	Cathode-to-Anode Voltage	600	V
$I_F @ T_C = 25^\circ C$	Continuous Forward Current	75	A
$I_F @ T_C = 100^\circ C$	Continuous Forward Current	40	
$I_{FSM}$	Single Pulse Forward Current	TBD	
$I_{FRM}$	Maximum Repetitive Forward Current	180	
$V_{ISOL}$	RMS Isolation Voltage, Any Terminal to Case, t=1 min	2500	V
$P_D @ T_C = 25^\circ C$	Maximum Power Dissipation	180	W
$P_D @ T_C = 100^\circ C$	Maximum Power Dissipation	71	
$T_J$	Operating Junction and	-55 to +150	$^\circ C$
$T_{STG}$	Storage Temperature Range		

\*125  $^\circ C$

## Electrical Characteristics (per Leg) @ $T_J = 25^\circ\text{C}$ (unless otherwise specified)

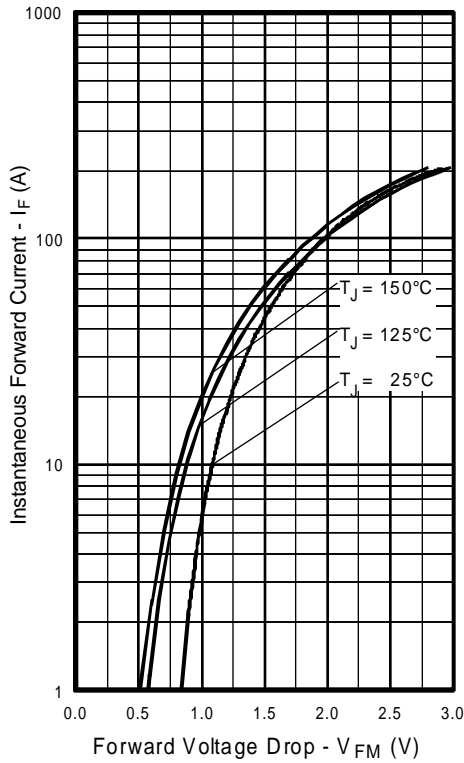
	Parameter	Min.	Typ.	Max.	Units	Test Conditions
$V_{BR}$	Cathode Anode Breakdown Voltage	600	—	—	V	$I_R = 100\mu\text{A}$
$V_{FM}$	Max Forward Voltage	—	1.5	1.7	V	$I_F = 60\text{A}$
		—	1.9	2.1		$I_F = 120\text{A}$ See Fig. 1
		—	1.4	1.6		$I_F = 60\text{A}, T_J = 125^\circ\text{C}$
$I_{RM}$	Max Reverse Leakage Current	—	2.5	20	$\mu\text{A}$	$V_R = V_R$ Rated See Fig. 2
		—	130	2000		$T_J = 125^\circ\text{C}, V_R = 0.8 \times V_R$ Rated
$C_T$	Junction Capacitance	—	120	170	pF	$V_R = 200\text{V}$ See Fig. 3

## Dynamic Recovery Characteristics (per Leg) @ $T_J = 25^\circ\text{C}$ (unless otherwise specified)

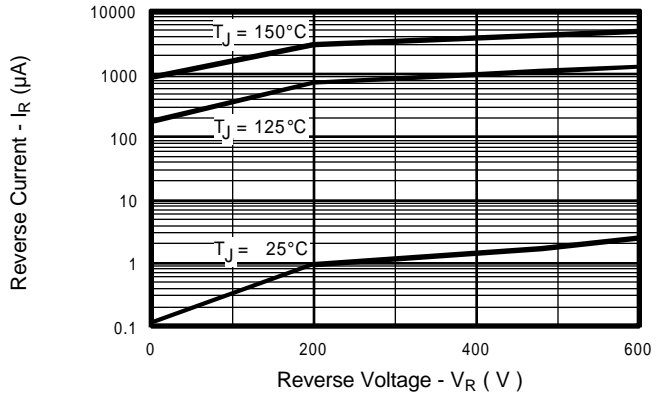
	Parameter	Min.	Typ.	Max.	Units	Test Conditions	
$t_{rr}$	Reverse Recovery Time	—	34	—	ns	$I_F = 1.0\text{A}, di/dt = 200\text{A}/\mu\text{s}, V_R = 30\text{V}$	
$t_{rr1}$	See Fig. 5, 6 & 16	—	65	98			$T_J = 25^\circ\text{C}$
$t_{rr2}$		—	130	200			$T_J = 125^\circ\text{C}$
$I_{RRM1}$	Peak Recovery Current	—	7.0	13	A	$T_J = 25^\circ\text{C}$	
$I_{RRM2}$	See Fig. 7 & 8	—	13	23			$T_J = 125^\circ\text{C}$
$Q_{rr1}$	Reverse Recovery Charge	—	270	410	nC	$T_J = 25^\circ\text{C}$	
$Q_{rr2}$	See Fig. 9 & 10	—	490	740			$T_J = 125^\circ\text{C}$
$di_{(rec)M}/dt1$	Peak Rate of Fall of Recovery Current	—	350	—	$\text{A}/\mu\text{s}$	$T_J = 25^\circ\text{C}$	
$di_{(rec)M}/dt2$	During $t_b$ See Fig. 11 & 12	—	270	—			$T_J = 125^\circ\text{C}$

## Thermal - Mechanical Characteristics

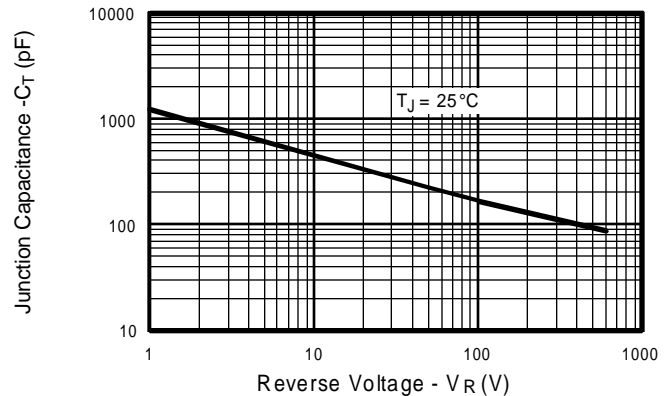
	Parameter	Min.	Typ.	Max.	Units
$R_{\theta JC}$	Junction-to-Case, Single Leg Conducting	—	—	0.70	$^\circ\text{C}/\text{W}$ $\text{K}/\text{W}$
	Junction-to-Case, Both Legs Conducting	—	—	0.35	
$R_{\theta CS}$	Case-to-Sink, Flat, Greased Surface	—	0.05	—	
$Wt$	Weight	—	30	—	gm
	Mounting Torque	—	1.3	—	(N•m)



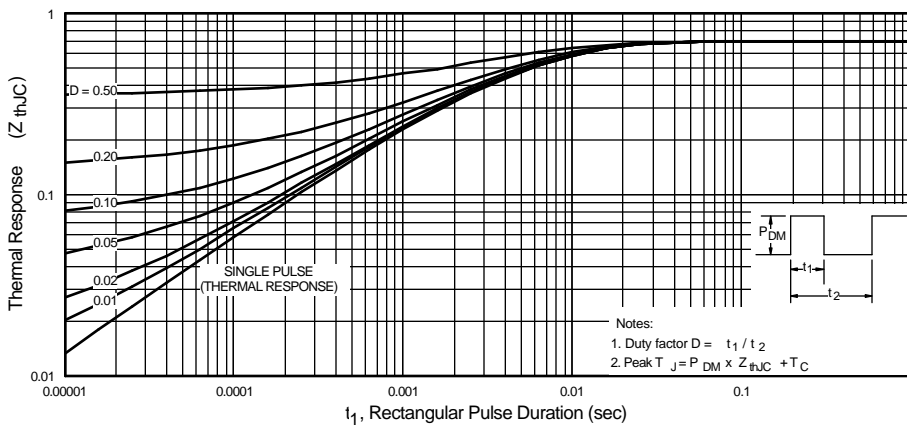
**Fig. 1** - Maximum Forward Voltage Drop vs. Instantaneous Forward Current, (per Leg)



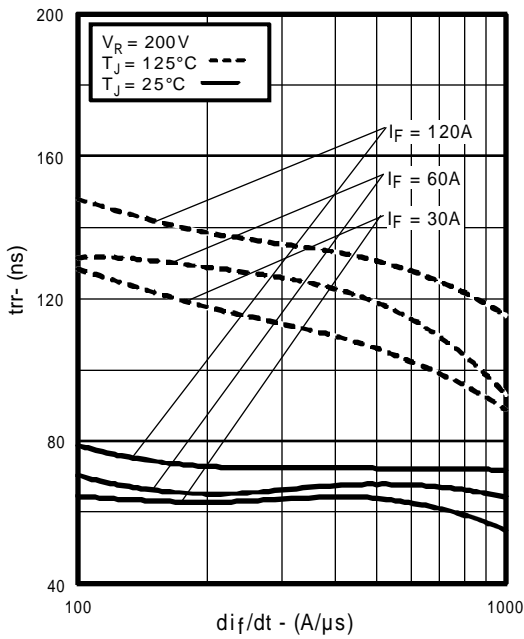
**Fig. 2** - Typical Reverse Current vs. Reverse Voltage, (per Leg)



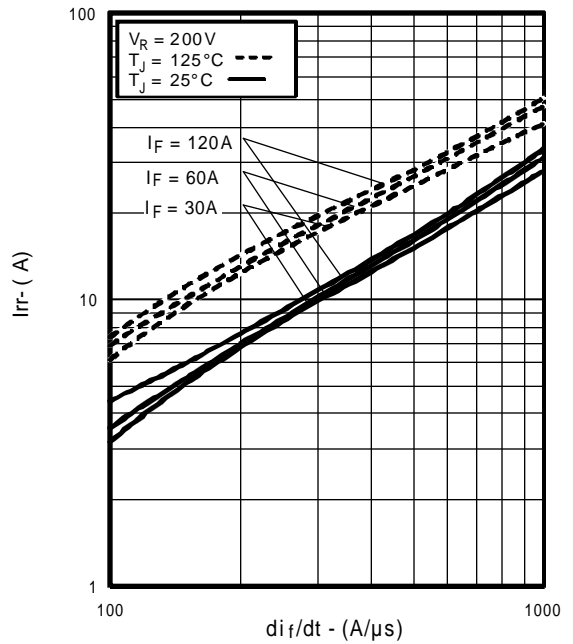
**Fig. 3** - Typical Junction Capacitance vs. Reverse Voltage, (per Leg)



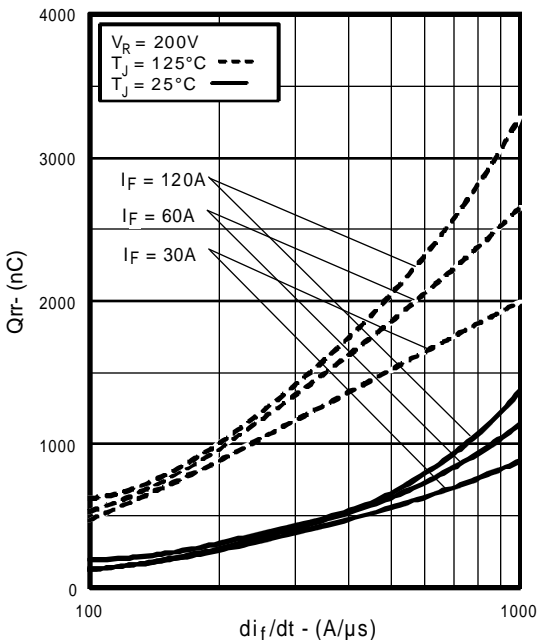
**Fig. 4** - Maximum Thermal Impedance  $Z_{thJC}$  Characteristics, (per Leg)



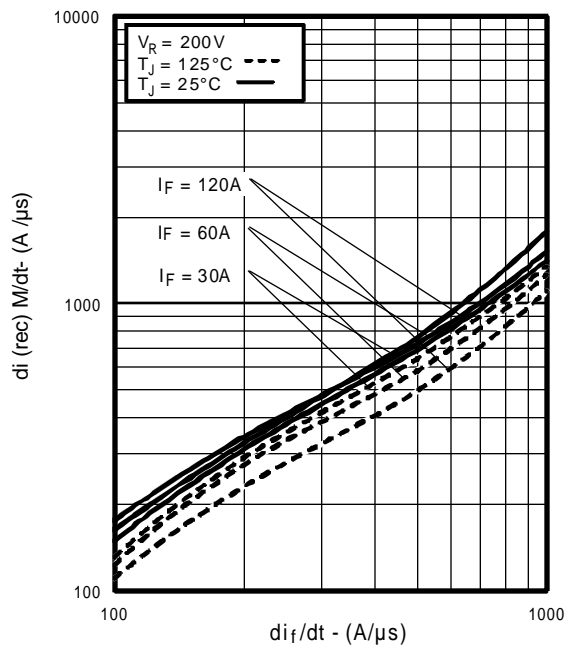
**Fig. 5** - Typical Reverse Recovery vs.  $di_f/dt$ ,  
 (per Leg)



**Fig. 6** - Typical Recovery Current vs.  $di_f/dt$ ,  
 (per Leg)

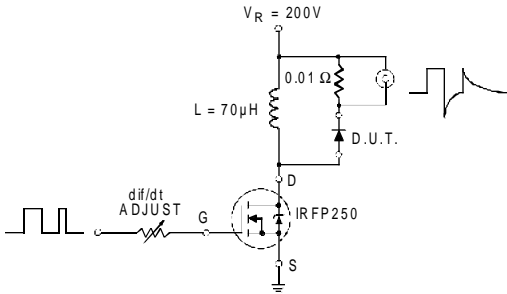


**Fig. 7** - Typical Stored Charge vs.  $di_f/dt$ ,  
 (per Leg)

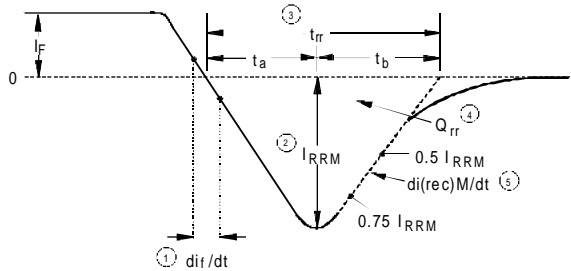


**Fig. 8** - Typical  $di_{(rec)}M/dt$  vs.  $di_f/dt$ ,  
 (per Leg)

REVERSE RECOVERY CIRCUIT



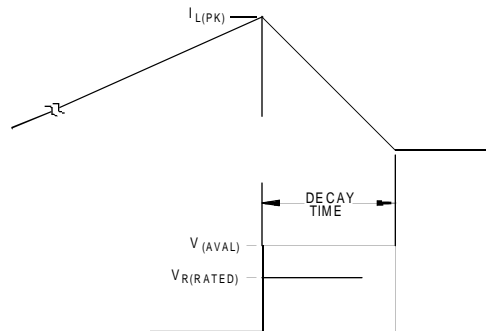
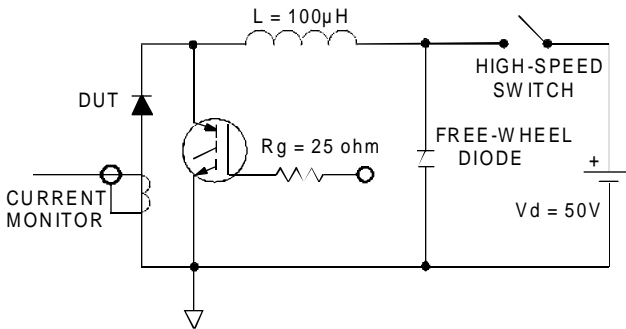
**Fig. 9** - Reverse Recovery Parameter Test Circuit



1.  $di/dt$  - Rate of change of current through zero crossing
2.  $I_{RRM}$  - Peak reverse recovery current
3.  $t_{rr}$  - Reverse recovery time measured from zero crossing point of negative going  $I_F$  to point where a line passing through  $0.75 I_{RRM}$  and  $0.50 I_{RRM}$  extrapolated to zero current
4.  $Q_{rr}$  - Area under curve defined by  $t_{rr}$  and  $I_{RRM}$   

$$Q_{rr} = \frac{t_{rr} \times I_{RRM}}{2}$$
5.  $di_{(rec)M}/dt$  - Peak rate of change of current during  $t_b$  portion of  $t_{rr}$

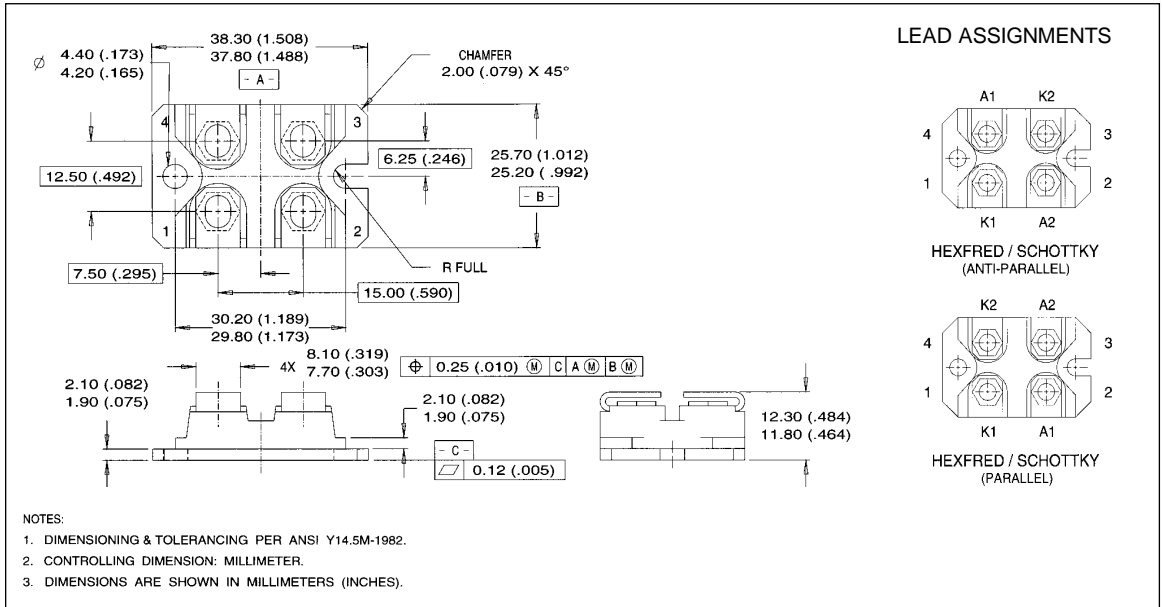
**Fig. 10** - Reverse Recovery Waveform and Definitions



**Fig. 11** - Avalanche Test Circuit and Waveforms

# HFA120FA60, HFA120EA60

## SOT-227 Package Details



## Tube

QUANTITIES PER TUBE IS 10  
M4 SREW AND WASHER INCLUDED

