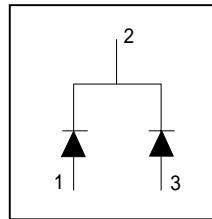


### Features

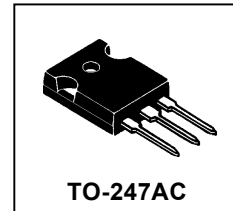
- Ultrafast Recovery
- Ultrasoft Recovery
- Very Low  $I_{RRM}$
- Very Low  $Q_{rr}$
- Specified at Operating Conditions

### Benefits

- Reduced RFI and EMI
- Reduced Power Loss in Diode and Switching Transistor
- Higher Frequency Operation
- Reduced Snubbing
- Reduced Parts Count



*	
$V_R$	= 1200V
$V_F$ (max.)	= 3.3V
$I_F$ (AV)	= 8.0A
$I_{RRM}$ (typ.)	= 4.5A
* per Leg	



### Description

International Rectifier's HFA16PA120C is a state of the art ultra fast recovery diode. Employing the latest in epitaxial construction and advanced processing techniques it features a superb combination of characteristics which result in performance which is unsurpassed by any rectifier previously available. With basic ratings of 1200 volts and 8 amps continuous current, the HFA16PA120C is especially well suited for use as the companion diode for IGBTs and MOSFETs. In addition to ultra fast recovery time, the HEXFRED product line features extremely low values of peak recovery current ( $I_{RRM}$ ) and does not exhibit any tendency to "snap-off" during the  $t_b$  portion of recovery. The HEXFRED features combine to offer designers a rectifier with lower noise and significantly lower switching losses in both the diode and the switching transistor. These HEXFRED advantages can help to significantly reduce snubbing, component count and heatsink sizes. The HEXFRED HFA16PA120C is ideally suited for applications in power supplies and power conversion systems (such as inverters), motor drives, and many other similar applications where high speed, high efficiency is needed.

### Absolute Maximum Ratings (per Leg)

	Parameter	Max	Units
$V_R$	Cathode-to-Anode Voltage	1200	V
$I_F$ @ $T_C = 100^\circ\text{C}$	Continuous Forward Current	8	A
$I_{FSM}$	Single Pulse Forward Current	130	
$I_{FRM}$	Maximum Repetitive Forward Current	32	
$P_D$ @ $T_C = 25^\circ\text{C}$	Maximum Power Dissipation	73.5	W
$P_D$ @ $T_C = 100^\circ\text{C}$	Maximum Power Dissipation	29	
$T_J$ $T_{STG}$	Operating Junction and Storage Temperature Range	- 55 to 150	$^\circ\text{C}$

**Electrical Characteristics (per Leg) @  $T_J = 25^\circ\text{C}$  (unless otherwise specified)**

Parameter	Min	Typ	Max	Units	Test Conditions
$V_{BR}$ Cathode Anode Breakdown Voltage	1200	-	-	V	$I_R = 100\mu\text{A}$
$V_{FM}$ Max. Forward Voltage	-	2.6	3.3	V	$I_F = 8.0\text{A}$
	-	3.4	4.3		$I_F = 16\text{A}$
	-	2.4	3.1		$I_F = 8.0\text{A}, T_J = 125^\circ\text{C}$
$I_{RM}$ Max. Reverse Leakage Current	-	0.31	10	$\mu\text{A}$	$V_R = V_R$ Rated
	-	135	1000		$T_J = 125^\circ\text{C}, V_R = 0.8 \times V_R$ Rated
$C_T$ Junction Capacitance	-	11	20	pF	$V_R = 200\text{V}$
$L_S$ Series Inductance	-	8.0	-	nH	Measured lead to lead 5mm from pkg

body

**Dynamic Recovery Characteristics (per Leg) @  $T_J = 25^\circ\text{C}$  (unless otherwise specified)**

Parameter	Min	Typ	Max	Units	Test Conditions	
$t_{rr}$ Reverse Recovery Time	-	28	-	ns	$I_F = 1.0\text{A}, di_F/dt = 200\text{A}/\mu\text{s}, V_R = 30\text{V}$	
$t_{rr1}$	-	63	95			$T_J = 25^\circ\text{C}$
$t_{rr2}$	-	106	160			$T_J = 125^\circ\text{C}$
$I_{RRM1}$ Peak Recovery Current	-	4.5	8.0	A	$T_J = 25^\circ\text{C}$	
	$I_{RRM2}$	-	6.2			11
$Q_{rr1}$ Reverse Recovery Charge	-	140	380	nC	$T_J = 25^\circ\text{C}$	
	$Q_{rr2}$	-	335			880
$di_{(rec)M}/dt1$ Peak Rate of Recovery	-	133	-	A/ $\mu\text{s}$	$T_J = 25^\circ\text{C}$	
$di_{(rec)M}/dt2$ Current During $t_b$	-	85	-			$T_J = 125^\circ\text{C}$

**Thermal - Mechanical Characteristics**

Parameter	Min	Typ	Max	Units
$T_{lead}^{\textcircled{1}}$ Lead Temperature	-	-	300	$^\circ\text{C}$
$R_{thJC}$ Thermal Resistance, Junction to Case	-	-	1.7	k/W
$R_{thJA}^{\textcircled{2}}$ Thermal Resistance, Junction to Ambient	-	-	40	
$R_{thCS}^{\textcircled{3}}$ Thermal Resistance, Case to Heat Sink	-	0.25	-	
$Wt$ Weight	-	6.0	-	g
	-	0.21	-	(oz)
Mounting Torque	6.0	-	12	Kg-cm
	5.0	-	10	lbf•in

<sup>①</sup> 0.063 in. from Case (1.6mm) for 10 sec<sup>②</sup> Typical Socket Mount<sup>③</sup> Mounting Surface, Flat, Smooth and Greased

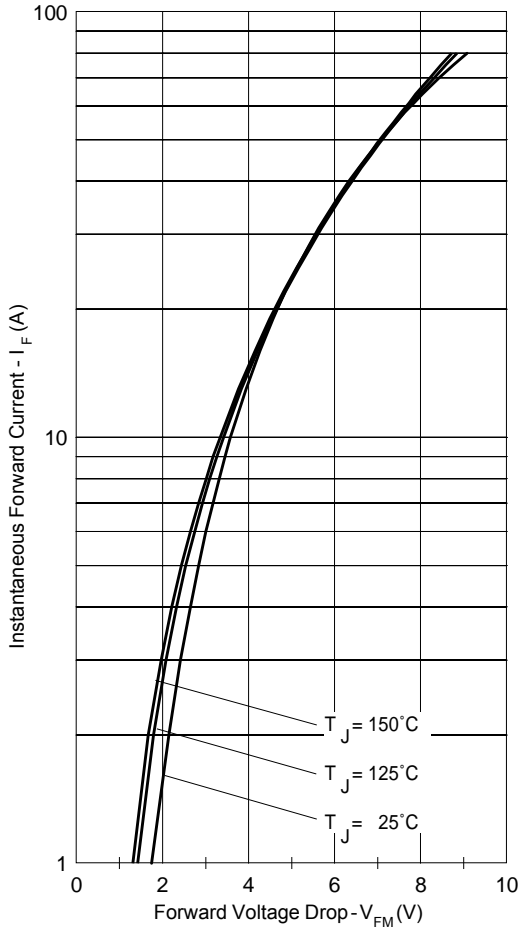


Fig. 1 - Max. Forward Voltage Drop Characteristics

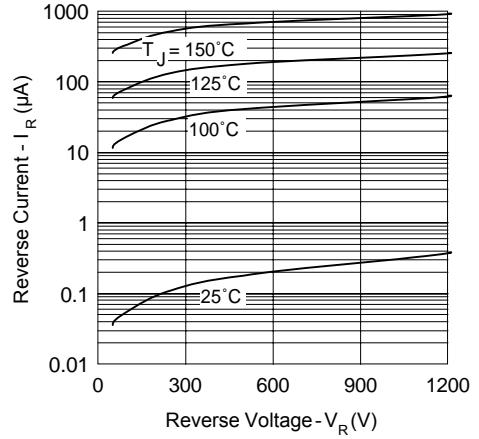


Fig. 2 - Typ. Values Of Reverse Current Vs. Reverse Voltage

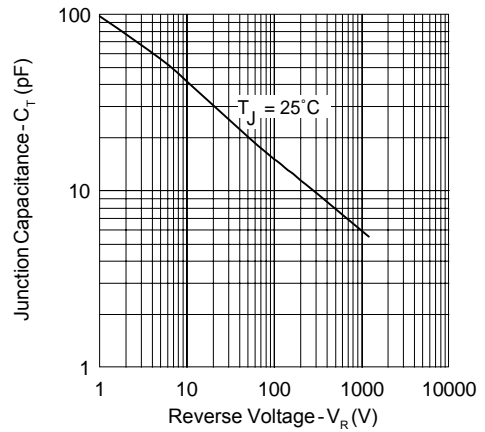


Fig. 3 - Typical Junction Capacitance Vs. Reverse Voltage

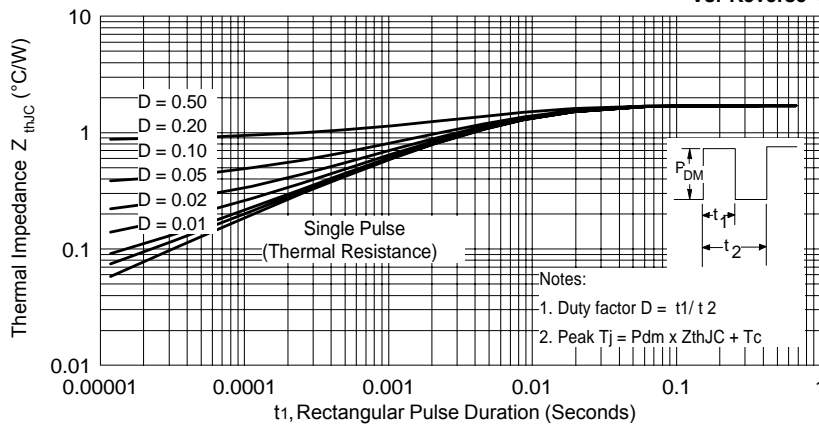
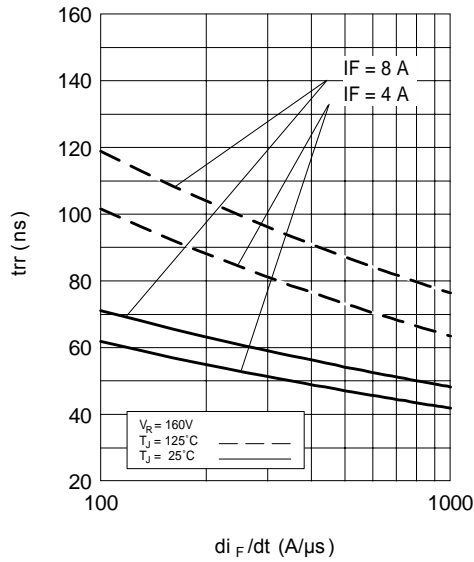
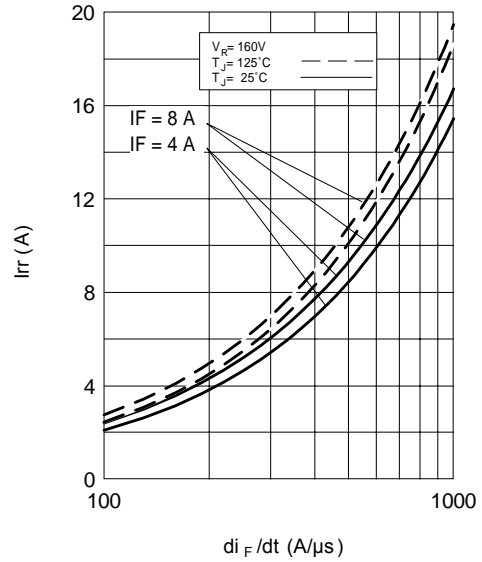


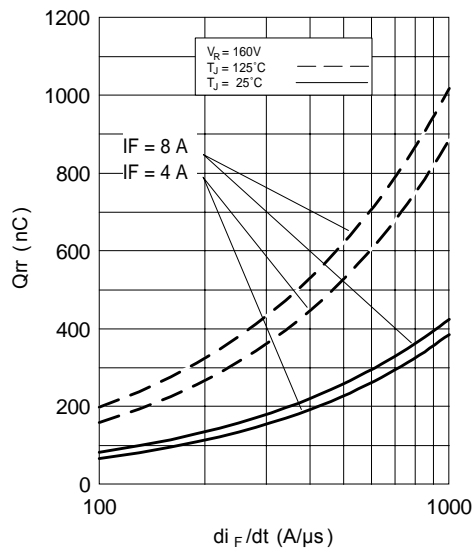
Fig. 4 - Max. Thermal Impedance  $Z_{thJC}$  Characteristics



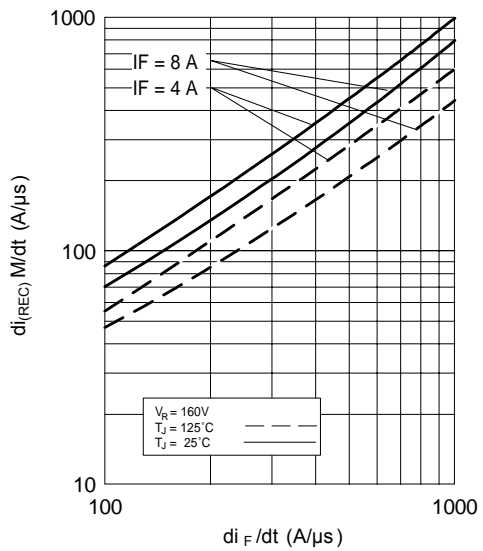
**Fig. 5 - Typical Reverse Recovery Vs.  $di_F/dt$**



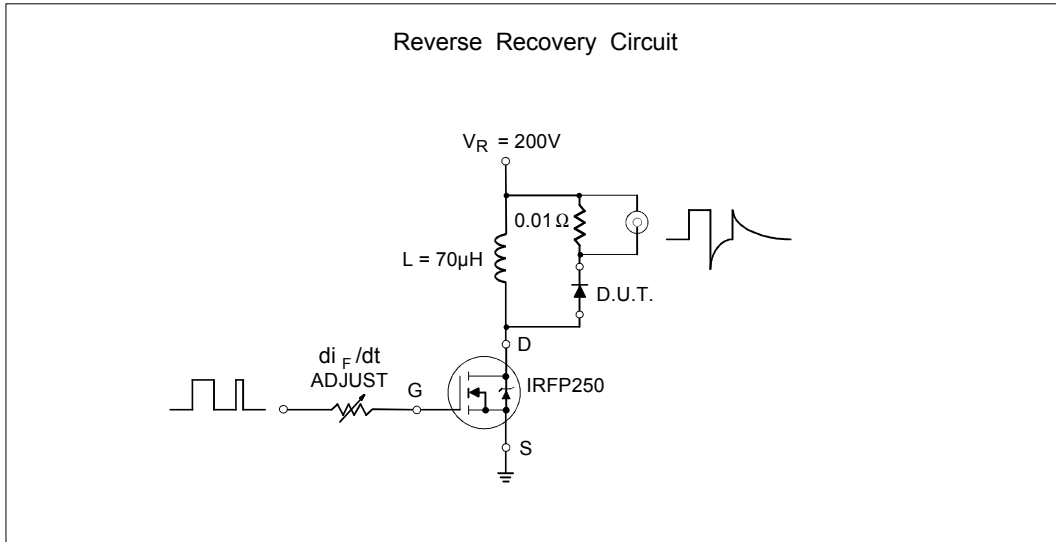
**Fig. 6 - Typical Recovery Current Vs.  $di_F/dt$**



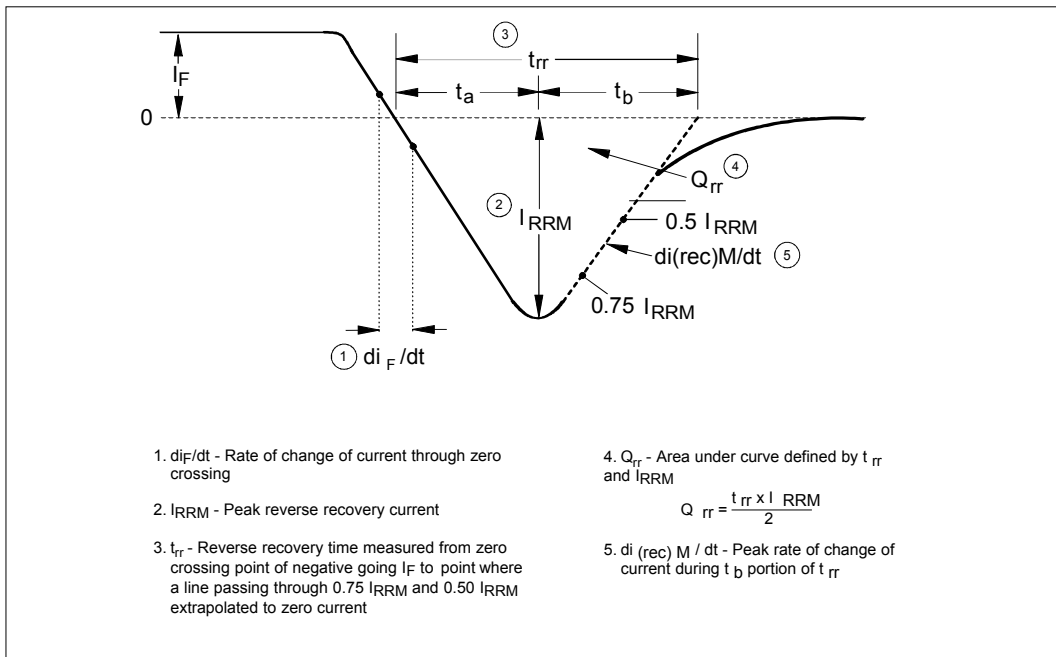
**Fig. 8 - Typical Stored Charge vs.  $di_F/dt$**



**Fig. 7 - Typical  $di_{(REC)} M/dt$  vs.  $di_F/dt$**

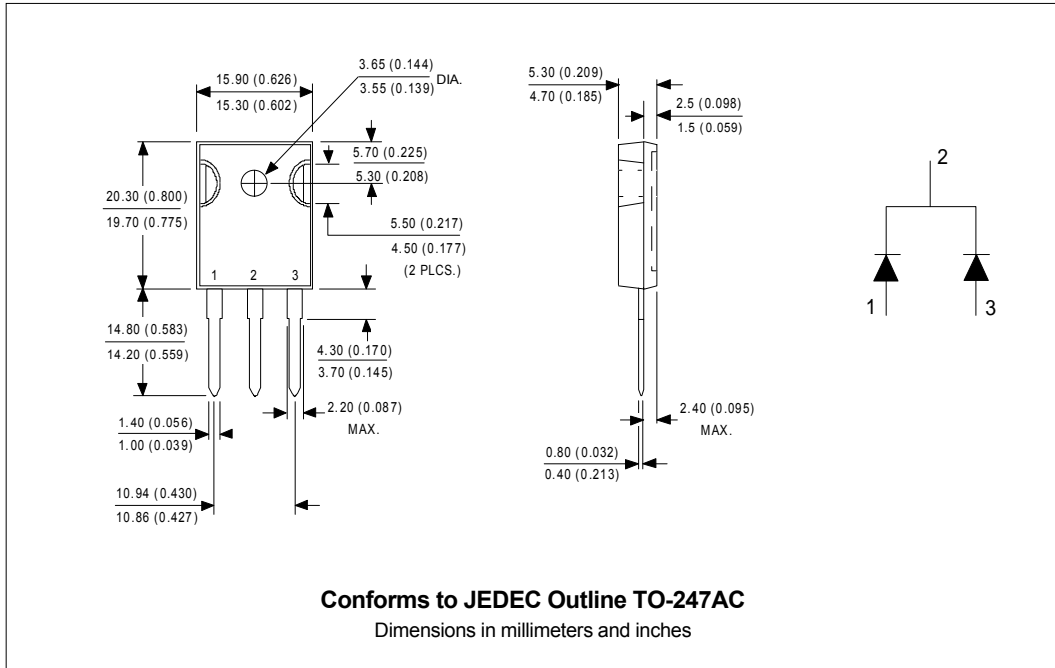


**Fig. 9- Reverse Recovery Parameter Test Circuit**



**Fig. 10 - Reverse Recovery Waveform and Definitions**

**Outline Table**



**Ordering Information Table**

Device Code					
HF	A	16	PA	120	C
①	②	③	④	⑤	⑥
<b>1</b>	-	Hexfred Family			
<b>2</b>	-	Process Designator A	= subs. elec. irradi.		
			B	= subs. Platinum	
<b>3</b>	-	Current Rating	(16 = 16A)		
<b>4</b>	-	Package Outline	(PA = TO-247, 3 pins)		
<b>5</b>	-	Voltage Rating	(120= 1200V)		
<b>6</b>	-	Configuration	(C = Center Tap Common Cathode)		

Data and specifications subject to change without notice.  
This product has been designed and qualified for Industrial Level.  
Qualification Standards can be found on IR's Web site.

International  
**IOR** Rectifier

**IR WORLD HEADQUARTERS:** 233 Kansas St., El Segundo, California 90245, USA Tel: (310) 252-7105  
TAC Fax: (310) 252-7309  
Visit us at [www.irf.com](http://www.irf.com) for sales contact information. 05/01