

International
IR Rectifier

HEXFRED™

HFA08PB120

Ultrafast, Soft Recovery Diode

Features

- Ultrafast Recovery
- Ultrasoft Recovery
- Very Low I_{RRM}
- Very Low Q_{rr}
- Specified at Operating Conditions

Benefits

- Reduced RFI and EMI
- Reduced Power Loss in Diode and Switching Transistor
- Higher Frequency Operation
- Reduced Snubbing
- Reduced Parts Count

Description

International Rectifier's HFA08PB120 is a state of the art ultra fast recovery diode. Employing the latest in epitaxial construction and advanced processing techniques it features a superb combination of characteristics which result in performance which is unsurpassed by any rectifier previously available. With basic ratings of 1200 volts and 8 amps continuous current, the HFA08PB120 is especially well suited for use as the companion diode for IGBTs and MOSFETs. In addition to ultra fast recovery time, the HEXFRED product line features extremely low values of peak recovery current (I_{RRM}) and does not exhibit any tendency to "snap-off" during the t_b portion of recovery. The HEXFRED features combine to offer designers a rectifier with lower noise and significantly lower switching losses in both the diode and the switching transistor. These HEXFRED advantages can help to significantly reduce snubbing, component count and heatsink sizes. The HEXFRED HFA08PB120 is ideally suited for applications in power supplies and power conversion systems (such as inverters), motor drives, and many other similar applications where high speed, high efficiency is needed.

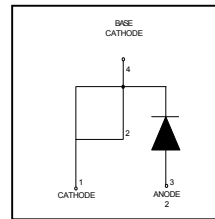

$V_R = 1200V$
V_F (typ.)* = 2.4V
I_F (AV) = 8.0A
Q_{rr} (typ.) = 140nC
I_{RRM} (typ.) = 4.5A
t_{rr} (typ.) = 28ns
$di_{(rec)M}/dt$ (typ.)* = 85A/μs

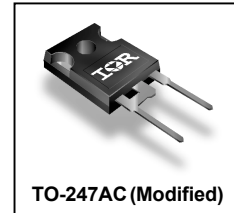

Absolute Maximum Ratings

	Parameter	Max	Units
V_R	Cathode-to-Anode Voltage	1200	V
$I_F @ T_C = 100^\circ C$	Continuous Forward Current	8.0	A
I_{FSM}	Single Pulse Forward Current	130	
I_{FRM}	Maximum Repetitive Forward Current	32	
$P_D @ T_C = 25^\circ C$	Maximum Power Dissipation	73.5	W
$P_D @ T_C = 100^\circ C$	Maximum Power Dissipation	29	
T_J	Operating Junction and	- 55 to 150	°C
T_{STG}	Storage Temperature Range		

*125°C

Electrical Characteristics @ $T_J = 25^\circ\text{C}$ (unless otherwise specified)

Parameter	Min	Typ	Max	Units	Test Conditions
V_{BR} Cathode Anode Breakdown Voltage	1200	-	-	V	$I_R = 100\mu\text{A}$
V_{FM} Max. Forward Voltage	-	2.6	3.3	V	$I_F = 8.0\text{A}$
	-	3.4	4.3		$I_F = 16\text{A}$ See Fig. 1
	-	2.4	3.1		$I_F = 8.0\text{A}, T_J = 125^\circ\text{C}$
I_{RM} Max. Reverse Leakage Current	-	0.31	10	μA	$V_R = V_R$ Rated See Fig. 2
	-	135	1000		$T_J = 125^\circ\text{C}, V_R = 0.8 \times V_R$ Rated
C_T Junction Capacitance	-	11	20	pF	$V_R = 200\text{V}$ See Fig. 3
L_S Series Inductance	-	8.0	-	nH	Measured lead to lead 5mm from pkg body

Dynamic Recovery Characteristics @ $T_J = 25^\circ\text{C}$ (unless otherwise specified)

Parameter	Min	Typ	Max	Units	Test Conditions	
t_{rr} Reverse Recovery Time	-	28	-	ns	$I_F = 1.0\text{A}, di/dt = 200\text{A}/\mu\text{s}, V_R = 30\text{V}$	
t_{rr1} See Fig. 5, 10	-	63	95			$T_J = 25^\circ\text{C}$
t_{rr2}	-	106	160			$T_J = 125^\circ\text{C}$
I_{RRM1} Peak Recovery Current	-	4.5	8.0	A	$T_J = 25^\circ\text{C}$	
	I_{RRM2} See Fig. 6	-	6.2			11
Q_{rr1} Reverse Recovery Charge	-	140	380	nC	$T_J = 25^\circ\text{C}$	
	Q_{rr2} See Fig. 7	-	335			880
$di_{(rec)M}/dt1$ Peak Rate of Recovery	-	133	-	A/ μs	$T_J = 25^\circ\text{C}$	
$di_{(rec)M}/dt2$ Current During t_b See Fig. 8	-	85	-			$T_J = 125^\circ\text{C}$

Thermal - Mechanical Characteristics

Parameter	Min	Typ	Max	Units
$T_{lead} \textcircled{1}$ Lead Temperature	-	-	300	$^\circ\text{C}$
R_{thJC} Thermal Resistance, Junction to Case	-	-	1.7	k/W
$R_{thJA} \textcircled{2}$ Thermal Resistance, Junction to Ambient	-	-	40	
$R_{thCS} \textcircled{3}$ Thermal Resistance, Case to Heat Sink	-	0.25	-	
Wt Weight	-	6.0	-	g
	-	0.21	-	(oz)
Mounting Torque	6.0	-	12	Kg-cm
	5.0	-	10	lbf-in

 $\textcircled{1}$ 0.063 in. from Case (1.6mm) for 10 sec $\textcircled{2}$ Typical Socket Mount $\textcircled{3}$ Mounting Surface, Flat, Smooth and Greased

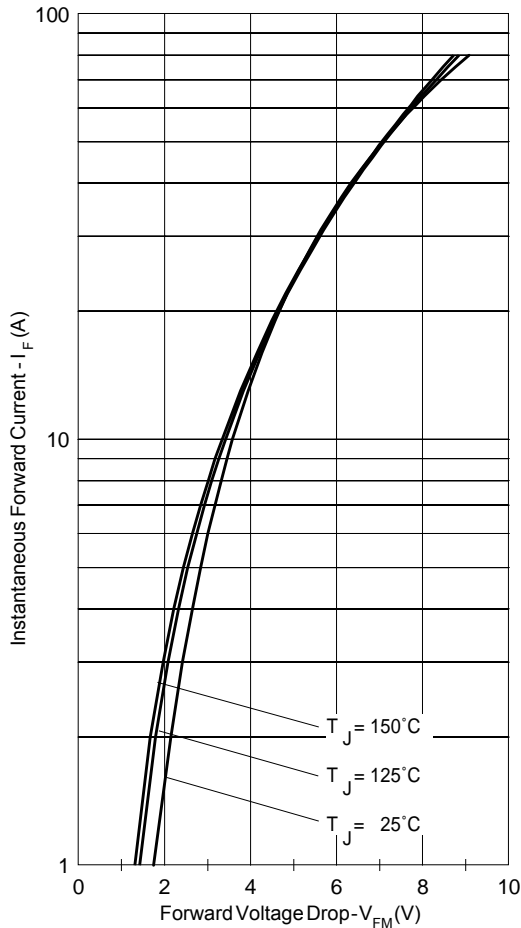

Fig. 1 - Max. Forward Voltage Drop Characteristics

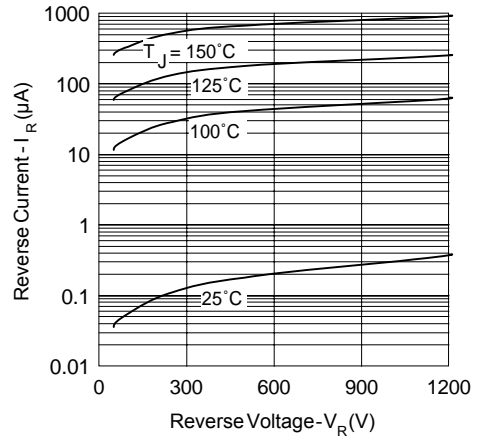

Fig. 2 - Typ. Values Of Reverse Current Vs. Reverse Voltage

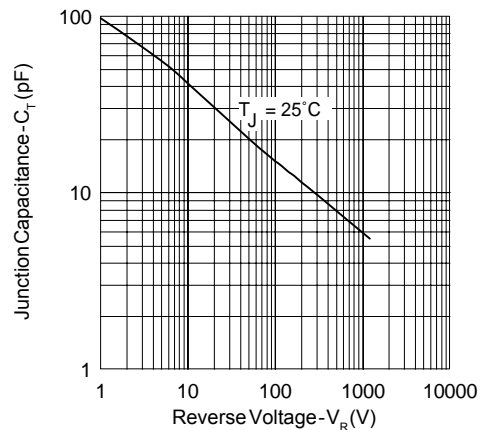

Fig. 3 - Typical Junction Capacitance Vs. Reverse Voltage

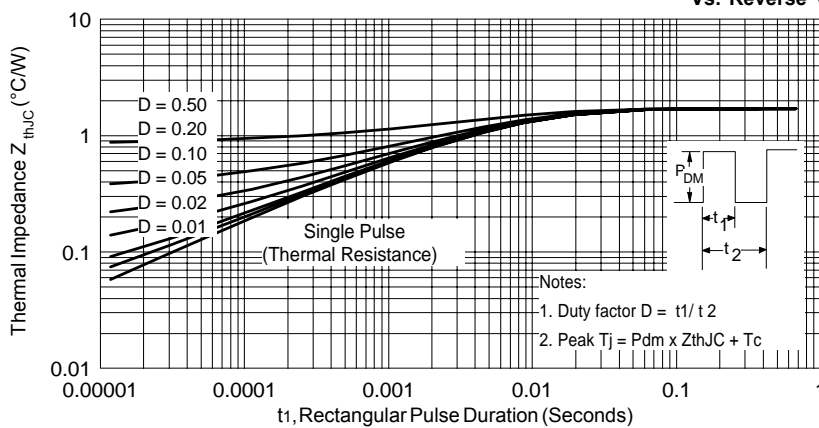

Fig. 4 - Max. Thermal Impedance Z_{thJC} Characteristics

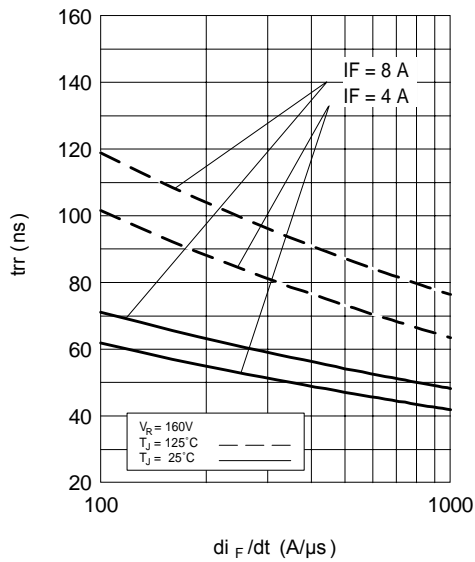

Fig. 5 - Typical Reverse Recovery Vs. di_f/dt

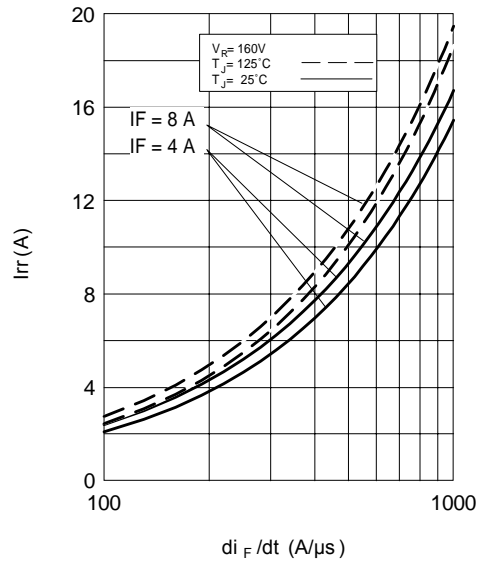

Fig. 6 - Typical Recovery Current Vs. di_f/dt

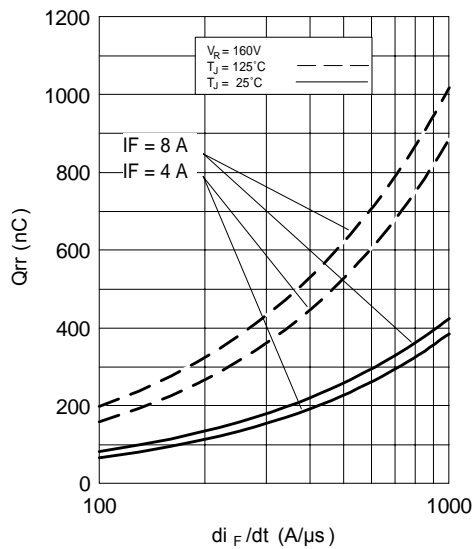

Fig. 8 - Typical Stored Charge vs. di_f/dt

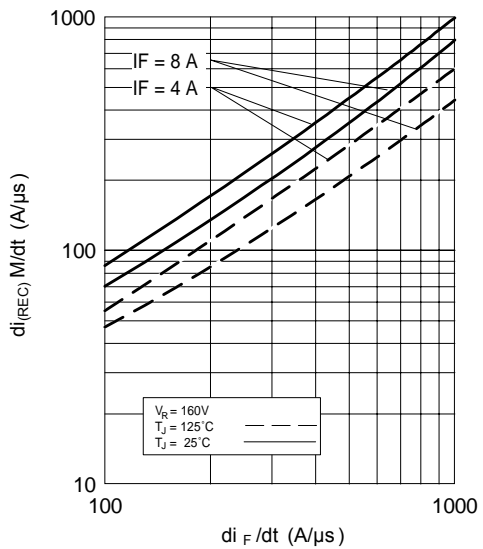

Fig. 7 - Typical $di_{(REC)} M/dt$ vs. di_f/dt

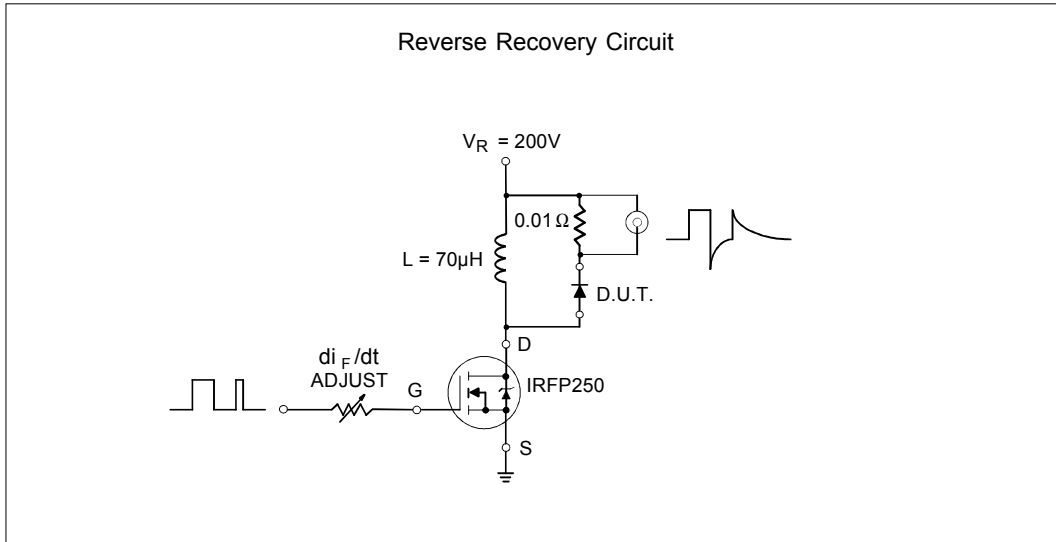

Fig. 9- Reverse Recovery Parameter Test Circuit

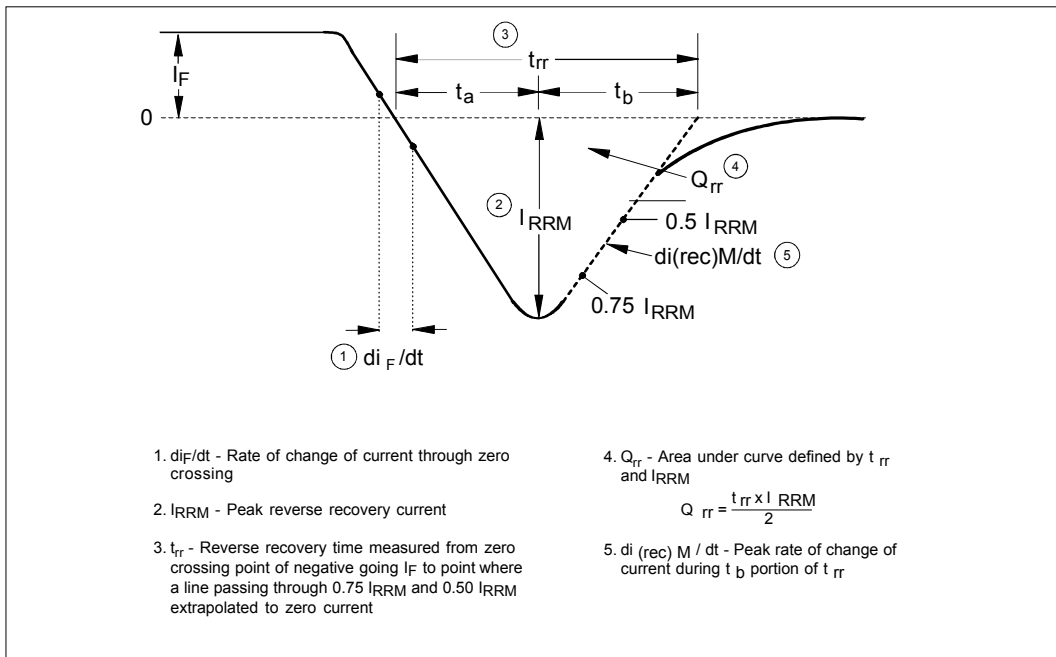
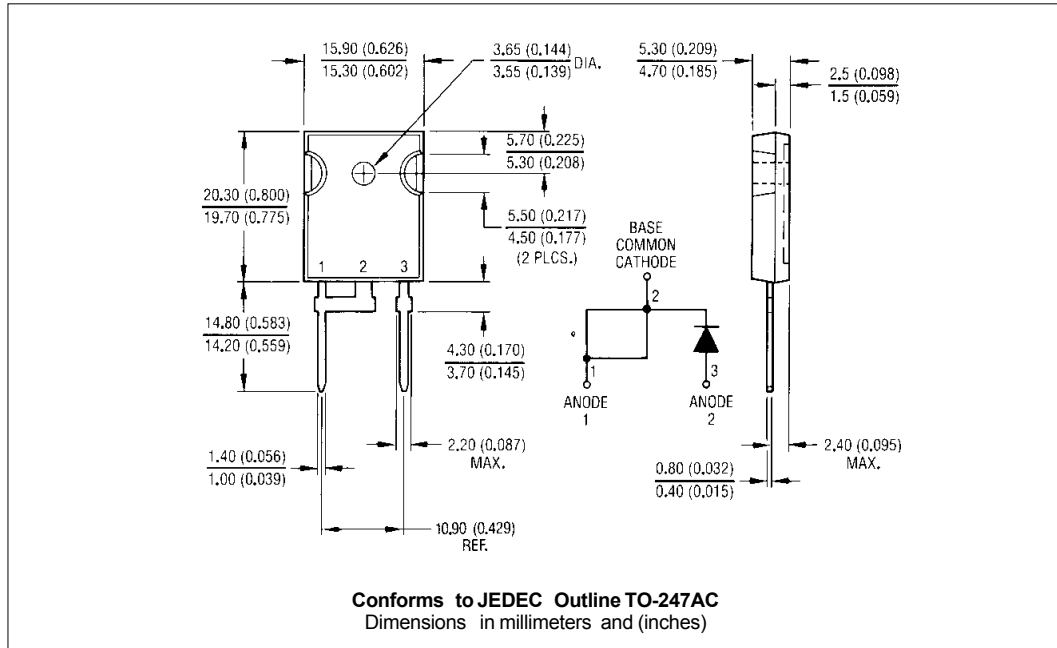

Fig. 10 - Reverse Recovery Waveform and Definitions

Outline Table



Ordering Information Table

Device Code				
HF	A	08	PB	120
①	②	③	④	⑤
1	- Hexfred Family			
2	- Process Designator	A = Electron Irradiated		
		B = Platinum Diffused		
3	- Current Rating	(08 = 8A)		
4	- Package Outline	(PB = TO-247, 2 pins)		
5	- Voltage Rating	(120 = 1200V)		

WORLD HEADQUARTERS
EUROPEAN HEADQUARTERS
IR CALIFORNIA
IR GERMANY
IR JAPAN
IR FAR EAST
IR SOUTHEAST ASIA
IR TEXAS

WORLDHEADQUARTERS: 233 Kansas St., El Segundo, California 90245 U.S.A. Tel: (310) 322 3331. Fax: (310) 322 3332.
EUROPEANHEADQUARTERS: Hurst Green, Oxted, Surrey RH8 9BB, U.K. Tel: ++ 44 1883 732020. Fax: ++ 44 1883 733408.
IR CANADA: 15 Lincoln Court, Brampton, Markham, Ontario L6T3Z2. Tel: (905) 453 2200. Fax: (905) 475 8801.
IR GERMANY: Saalburgstrasse 157, 61350 Bad Homburg. Tel: ++ 49 6172 96590. Fax: ++ 49 6172 965933.
IR ITALY: Via Liguria 49, 10071 Borgaro, Torino. Tel: ++ 39 11 4510111. Fax: ++ 39 11 4510220.
IR FAR EAST: K&H Bldg., 2F, 30-4 Nishi-Ikebukuro 3-Chome, Toshima-Ku, Tokyo, Japan 171. Tel: 81 3 3983 0086.
IR SOUTHEAST ASIA: 1 Kim Seng Promenade, Great World City West Tower,13-11, Singapore 237994. Tel: ++ 65 838 4630.
IR TAIWAN: 16 Fl. Suite D.207, Sec. 2, Tun Haw South Road, Taipei, 10673, Taiwan. Tel: 886 2 2377 9936.

<http://www.irf.com>

Fax-On-Demand: +44 1883 733420

Data and specifications subject to change without notice.