

FRED

HFB50HC20C

Ultrafast, Soft Recovery Diode

Features

- Reduced RFI and EMI
- Reduced Snubbing
- Extensive Characterization of Recovery Parameters
- Hermetic

$V_R = 200V$
$I_{F(AV)} = 50A$
$t_{rr} = 35ns$

Description

These Ultrafast, soft recovery diodes are optimized to reduce losses and EMI/RFI in high frequency power conditioning systems. An extensive characterization of the recovery behavior for different values of current, temperature and di/dt simplifies the calculations of losses in the operating conditions. The softness of the recovery eliminates the need for a snubber in most applications. These devices are ideally suited for power converters, motors drives and other applications where switching losses are significant portion of the total losses.

Absolute Maximum Ratings

	Parameter	Max.	Units
V_R	Cathode to Anode Voltage (Per Leg)	200	V
$I_{F(AV)}$	Continuous Forward Current, ① $T_C = 107^\circ C$	50	A
I_{FSM}	Single Pulse Forward Current, ② $T_C = 25^\circ C$ (Per Leg)	300	
$P_D @ T_C = 25^\circ C$	Maximum Power Dissipation	130	W
T_J, T_{STG}	Operating Junction and Storage Temperature Range	-55 to +150	$^\circ C$

Note: ① D.C. = 50% rect. wave
 ② 1/2 sine wave, 60 Hz , P.W. = 8.33 ms

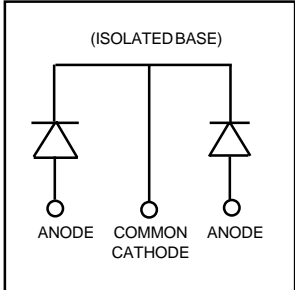
<p>CASE STYLE</p>  <p>TO-258AA</p>	<p>(ISOLATED BASE)</p>  <p>ANODE COMMON CATHODE ANODE</p>
---	---

Electrical Characteristics (Per Leg)@ T_J = 25°C (unless otherwise specified)

	Parameter	Min.	Typ.	Max.	Units	Test Conditions
V _{BR}	Cathode Anode Breakdown Voltage	200	—	—	V	I _R = 100μA
V _F	Forward Voltage See Fig. 1	—	—	1.36	V	I _F = 25A, T _J = -55°C
		—	—	1.20		I _F = 25A, T _J = 25°C
		—	—	1.49		I _F = 50A, T _J = 25°C
		—	—	0.99		I _F = 25A, T _J = 125°C
I _R	Reverse Leakage Current See Fig. 2	—	—	1.0	μA	V _R = V _R Rated
		—	—	100	μA	V _R = V _R Rated, T _J = 125°C
C _T	Junction Capacitance, See Fig. 3	—	—	200	pF	V _R = 200V
L _S	Series Inductance	—	8.7	—	nH	Measured from anode lead to cathode lead , 6mm (0.025 in) from package

Dynamic Recovery Characteristics (Per Leg) @ T_J = 25°C (unless otherwise specified)

	Parameter	Min.	Typ.	Max.	Units	Test Conditions
t _{rr}	Reverse Recovery Time	—	—	35	ns	I _F = 0.5A, V _R = 30V, di _t /dt = 300A/μs
t _{rr1}	Reverse Recovery Time	—	46	—	ns	T _J = 25°C See Fig.
t _{rr2}		—	84	—		T _J = 125°C 5
I _{RRM1}	Peak Recovery Current	—	5.7	—	A	T _J = 25°C See Fig.
I _{RRM2}		—	12.5	—		T _J = 125°C 6
Q _{rr1}	Reverse Recovery Charge	—	150	—	nC	T _J = 25°C See Fig.
Q _{rr2}		—	595	—		T _J = 125°C 7
di _{(rec)M} /dt1	Peak Rate of Fall of Recovery Current During t _b	—	530	—	A/μs	T _J = 25°C See Fig.
di _{(rec)M} /dt2		—	1130	—		T _J = 125°C 8

Thermal - Mechanical Characteristics

	Parameter	Typ.	Max.	Units
R _{thJC}	Junction-to-Case, Single Leg Conducting	—	0.96	°C/W
Wt	Weight	10.9	—	g

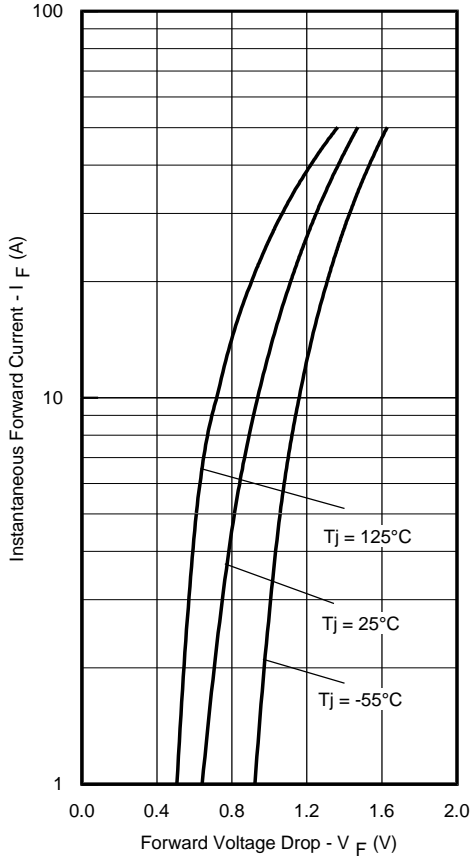

Fig. 1 - Maximum Forward Voltage Drop Vs. Instantaneous Forward Current (Per Leg)

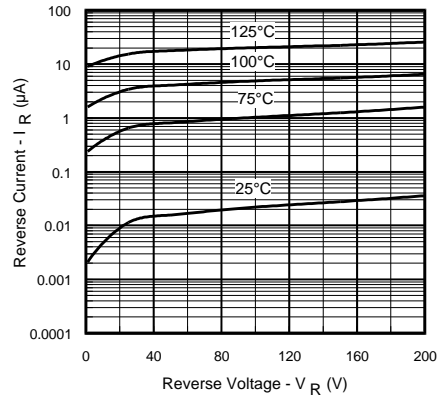

Fig. 2 - Typical Reverse Current Vs. Reverse Voltage (Per Leg)

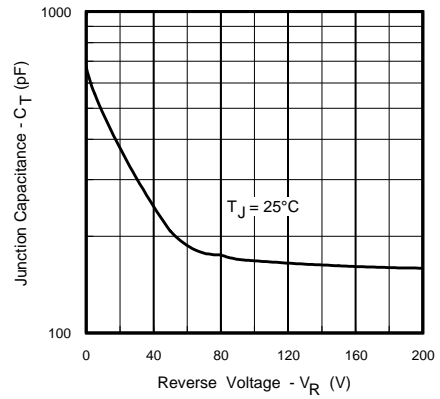

Fig. 3 - Typical Junction Capacitance Vs. Reverse Voltage (Per Leg)

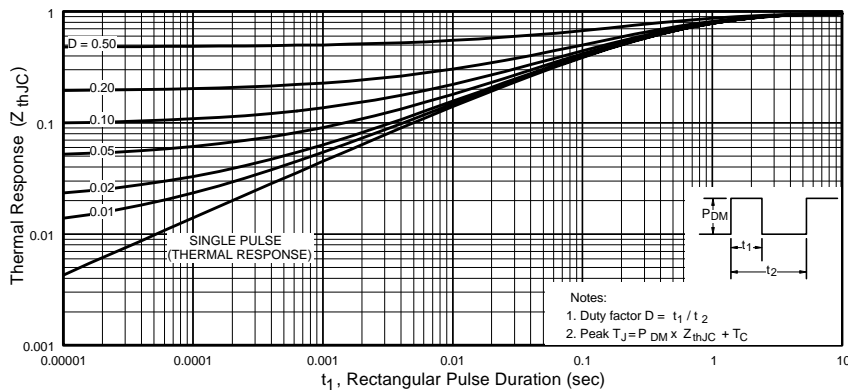

Fig. 4 - Maximum Thermal Impedance Z_{thjc} Characteristics (Per Leg)

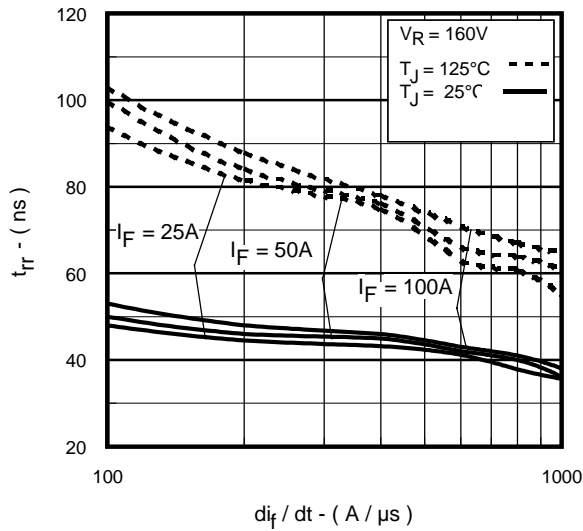

Fig. 5 - Typical Reverse Recovery Vs. di_f/dt (Per Leg)

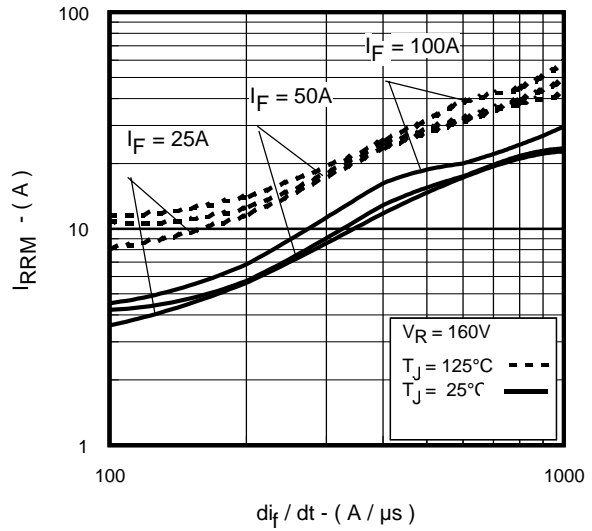

Fig. 6 - Typical Recovery Current Vs. di_f/dt (Per Leg)

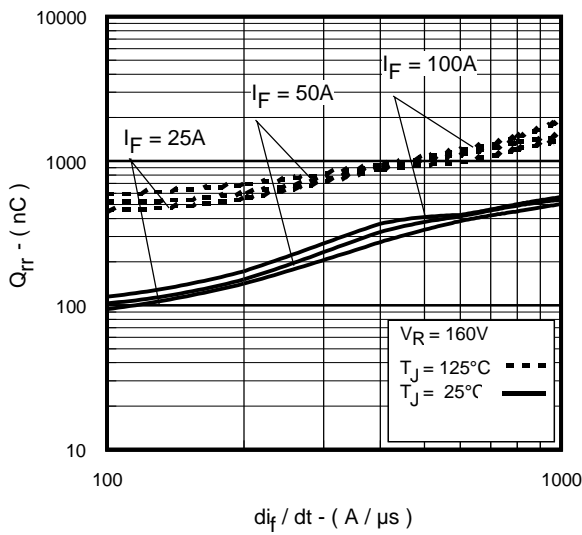

Fig. 7 - Typical Stored Charge Vs. di_f/dt (Per Leg)

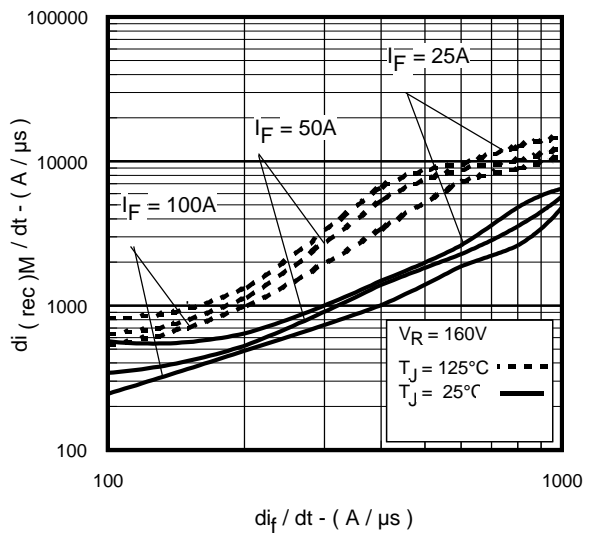

Fig. 8 - Typical $di_{(rec)M}/dt$ Vs. di_f/dt (Per Leg)

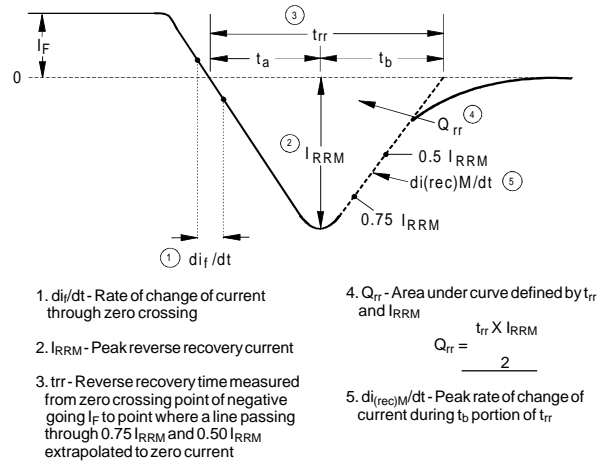
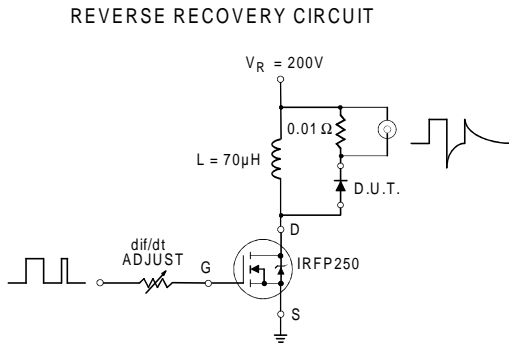
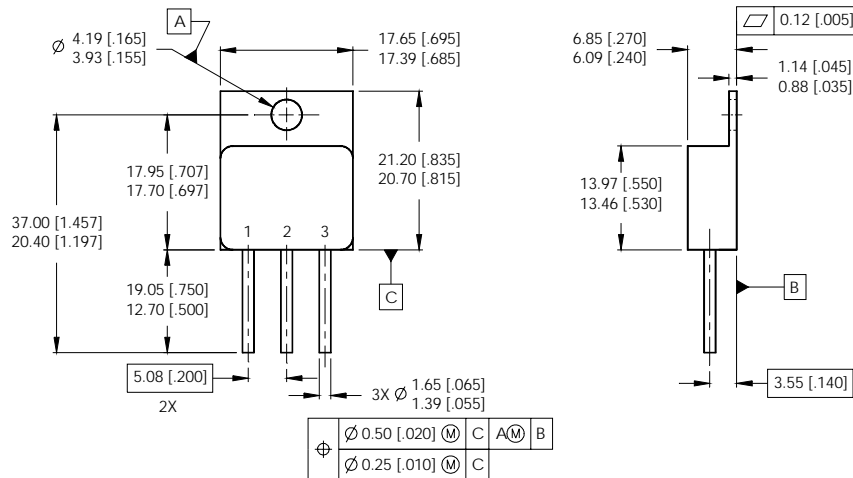

Fig. 9 - Reverse Recovery Parameter Test Circuit

Fig. 10 - Reverse Recovery Waveform and Definitions

Case Outline and Dimensions — TO-258AA



NOTES:

1. DIMENSIONING & TOLERANCING PER ASME Y14.5M-1994.
2. ALL DIMENSIONS ARE SHOWN IN MILLIMETERS [INCHES].
3. CONTROLLING DIMENSION: INCH.
4. CONFORMS TO JEDEC OUTLINE TO-258AA.

PIN ASSIGNMENTS

- 1 = ANODE 1
- 2 = COMMON CATHODE
- 3 = ANODE 2