

10-Bit, 125/60MSPS, High Speed D/A Converter

The HI5760 is a 10-bit, 125MSPS, high speed, low power, D/A converter which is implemented in an advanced CMOS process. Operating from a single +3V to +5V supply, the converter provides 20mA of full scale output current and includes edge-triggered CMOS input data latches. Low glitch energy and excellent frequency domain performance are achieved using a segmented current source architecture. For an equivalent performance dual version, see the HI5728.

This device complements the CommLink™ HI5X60 family of high speed converters offered by Intersil, which includes 8, 10, 12, and 14-bit devices.

Ordering Information

PART NUMBER	TEMP. RANGE (°C)	PACKAGE	PKG. NO.	CLOCK SPEED
HI5760BIB	-40 to 85	28 Ld SOIC	M28.3	125MHz
HI5760IA	-40 to 85	28 Ld TSSOP	M28.173	125MHz
HI5760/6IB†	-40 to 85	28 Ld SOIC	M28.3	60MHz
HI5760/6IA†	-40 to 85	28 Ld TSSOP	M28.173	60MHz
HI5760EVAL1	25	Evaluation Platform		125MHz

† Contact factory for availability.

Pinout

**HI5760 (SOIC, TSSOP)
TOP VIEW**

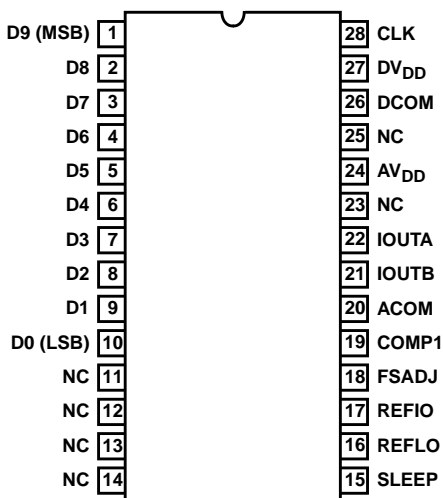

Features

- Throughput Rate 125MSPS
- Low Power 165mW at 5V, 27mW at 3V
- Power Down Mode 23mW at 5V, 10mW at 3V
- Integral Linearity Error ±1 LSB
- Adjustable Full Scale Output Current 2mA to 20mA
- SFDR to Nyquist at 5MHz Output 68dBc
- Internal 1.2V Temperature Compensated Bandgap Voltage Reference
- Single Power Supply from +5V to +3V
- CMOS Compatible Inputs
- Excellent Spurious Free Dynamic Range

Applications

- Cable Modems
- Set Top Boxes
- Wireless Communications
- Direct Digital Frequency Synthesis
- Signal Reconstruction
- Test Instrumentation
- High Resolution Imaging Systems
- Arbitrary Waveform Generators

Typical Applications Circuit

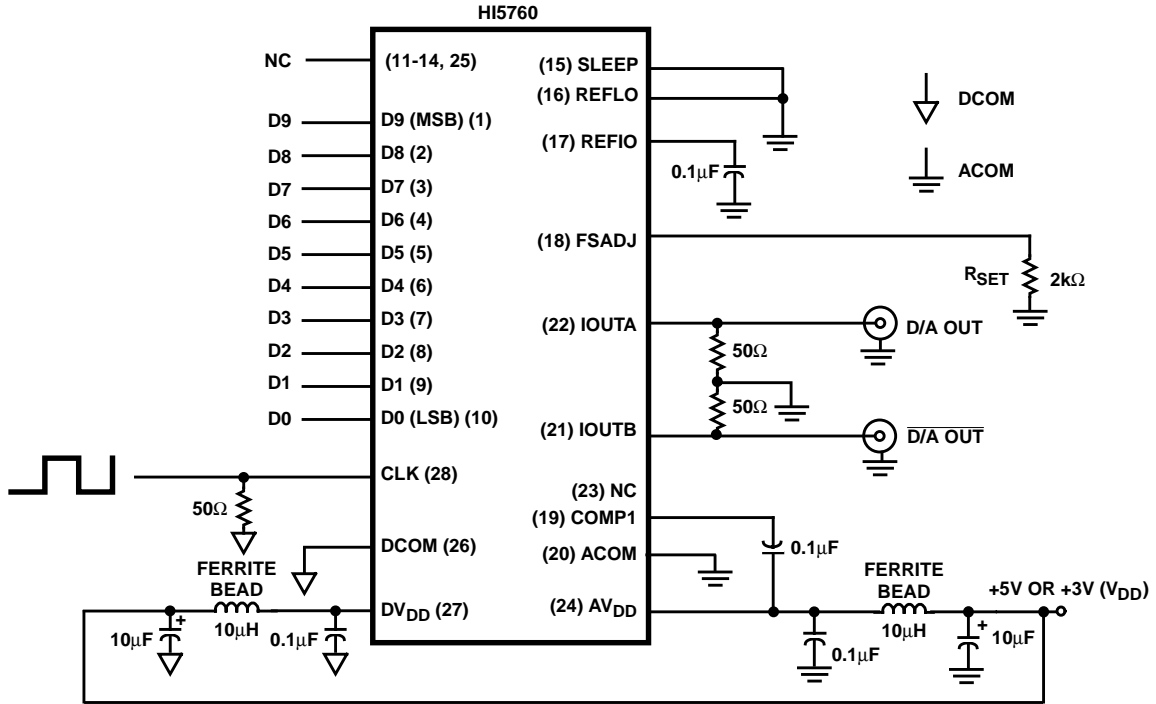

Functional Block Diagram

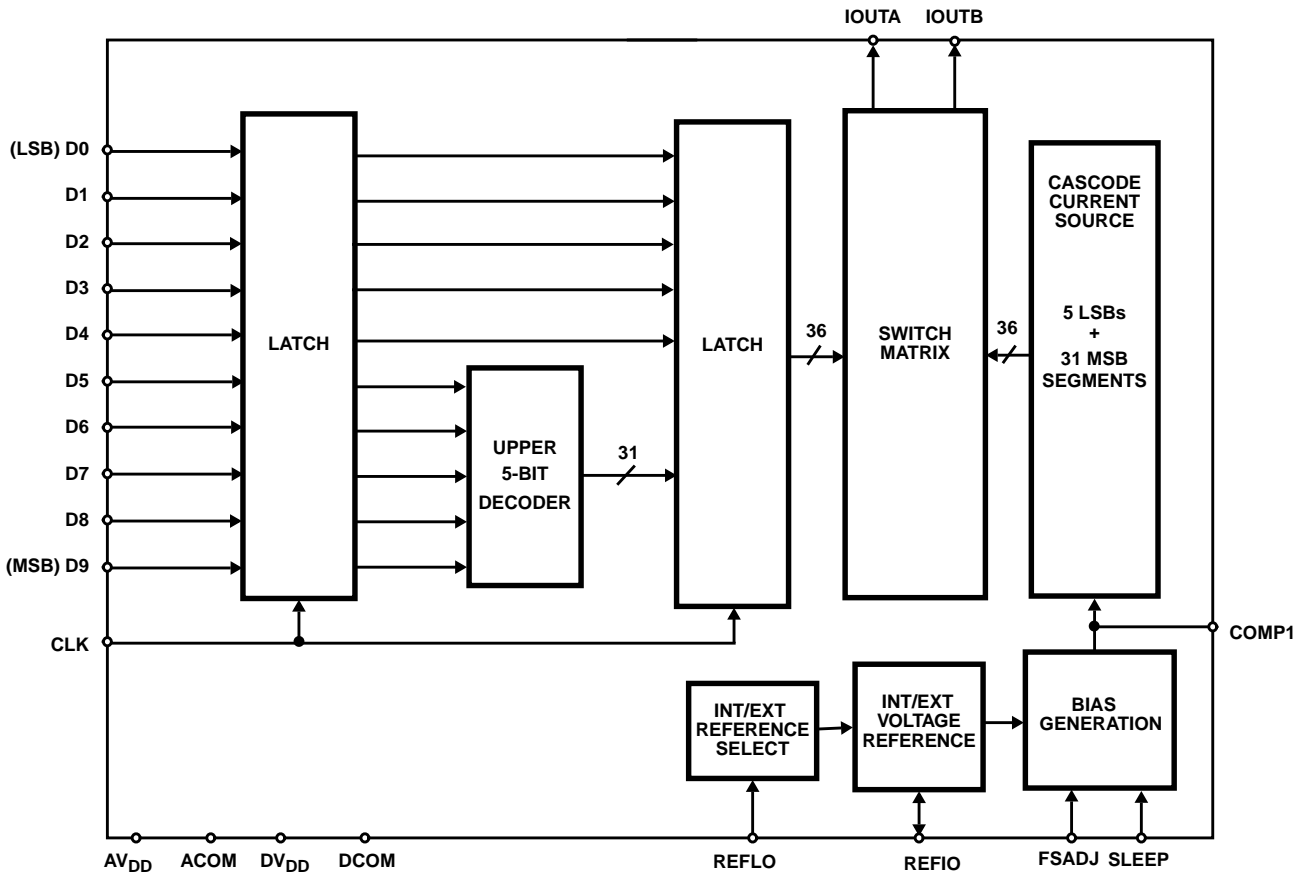

Absolute Maximum Ratings

Digital Supply Voltage DV_{DD} to DCOM	+5.5V
Analog Supply Voltage AV_{DD} to ACOM	+5.5V
Grounds, ACOM TO DCOM	-0.3V To +0.3V
Digital Input Voltages (D9-D0, CLK, SLEEP)	$DV_{DD} + 0.3V$
Internal Reference Output Current	$\pm 50\mu A$
Reference Input Voltage Range	$AV_{DD} + 0.3V$
Analog Output Current (I_{OUT})	24mA

Thermal Information

Thermal Resistance (Typical, Note 1)	θ_{JA} (°C/W)
SOIC Package	70
SSOP Package	117
Maximum Junction Temperature	
HI5760	150°C
Maximum Storage Temperature Range	-65°C to 150°C
Maximum Lead Temperature (Soldering 10s)	300°C
(SOIC - Lead Tips Only)	

Operating Conditions

Temperature Range -40°C to 85°C

CAUTION: Stresses above those listed in "Absolute Maximum Ratings" may cause permanent damage to the device. This is a stress only rating and operation of the device at these or any other conditions above those indicated in the operational sections of this specification is not implied.

NOTE:

- θ_{JA} is measured with the component mounted on an evaluation PC board in free air.

Electrical Specifications $AV_{DD} = DV_{DD} = +5V$, $V_{REF} = \text{Internal } 1.2V$, $I_{OUTFS} = 20mA$, $T_A = 25^\circ C$ for All Typical Values

PARAMETER	TEST CONDITIONS	HI5760 $T_A = -40^\circ C \text{ TO } 85^\circ C$			UNITS
		MIN	TYP	MAX	
SYSTEM PERFORMANCE					
Resolution		10	-	-	Bits
Integral Linearity Error, INL	"Best Fit" Straight Line (Note 7)	-1	± 0.5	+1	LSB
Differential Linearity Error, DNL	(Note 7)	-0.5	± 0.25	+0.5	LSB
Offset Error, I_{OS}	(Note 7)	-0.025		+0.025	% FSR
Offset Drift Coefficient	(Note 7)	-	0.1	-	ppm FSR/°C
Full Scale Gain Error, FSE	With External Reference (Notes 2, 7)	-10	± 2	+10	% FSR
	With Internal Reference (Notes 2, 7)	-10	± 1	+10	% FSR
Full Scale Gain Drift	With External Reference (Note 7)	-	± 50	-	ppm FSR/°C
	With Internal Reference (Note 7)	-	± 100	-	ppm FSR/°C
Full Scale Output Current, I_{FS}		2	-	20	mA
Output Voltage Compliance Range	(Note 3)	-0.3	-	1.25	V
DYNAMIC CHARACTERISTICS					
Maximum Clock Rate, f_{CLK}	(Note 3)	125	-	-	MHz
Output Settling Time, (t_{SETT})	0.2% (± 1 LSB, equivalent to 9 Bits) (Note 7)	-	20	-	ns
	0.1% ($\pm 1/2$ LSB, equivalent to 10 Bits) (Note 7)	-	35	-	ns
Singlet Glitch Area (Peak Glitch)	$R_L = 25\Omega$ (Note 7)	-	5	-	pV*s
Output Rise Time	Full Scale Step	-	1.0	-	ns
Output Fall Time	Full Scale Step	-	1.5	-	ns
Output Capacitance		-	10	-	pF
Output Noise	$I_{OUTFS} = 20mA$	-	50	-	pA/\sqrt{Hz}
	$I_{OUTFS} = 2mA$	-	30	-	pA/\sqrt{Hz}

HI5760

Electrical Specifications $AV_{DD} = DV_{DD} = +5V$, $V_{REF} = \text{Internal } 1.2V$, $I_{OUTFS} = 20mA$, $T_A = 25^{\circ}C$ for All Typical Values **(Continued)**

PARAMETER	TEST CONDITIONS	HI5760 $T_A = -40^{\circ}C \text{ TO } 85^{\circ}C$			UNITS
		MIN	TYP	MAX	
		AC CHARACTERISTICS - HI5760BIB, HI5760IA - 125MHz			
Spurious Free Dynamic Range, SFDR Within a Window	$f_{CLK} = 125MSPS$, $f_{OUT} = 32.9MHz$, 10MHz Span (Notes 4, 7)	-	75	-	dBc
	$f_{CLK} = 100MSPS$, $f_{OUT} = 5.04MHz$, 4MHz Span (Notes 4, 7)	-	76	-	dBc
	$f_{CLK} = 60MSPS$, $f_{OUT} = 10.1MHz$, 10MHz Span (Notes 4, 7)	-	75	-	dBc
	$f_{CLK} = 50MSPS$, $f_{OUT} = 5.02MHz$, 2MHz Span (Notes 4, 7)	-	76	-	dBc
	$f_{CLK} = 50MSPS$, $f_{OUT} = 1.00MHz$, 2MHz Span (Notes 4, 7)	-	78	-	dBc
Total Harmonic Distortion (THD) to Nyquist	$f_{CLK} = 100MSPS$, $f_{OUT} = 2.00MHz$ (Notes 4, 7)	-	71	-	dBc
	$f_{CLK} = 50MSPS$, $f_{OUT} = 2.00MHz$ (Notes 4, 7)	-	71	-	dBc
	$f_{CLK} = 50MSPS$, $f_{OUT} = 1.00MHz$ (Notes 4, 7)	-	76	-	dBc
Spurious Free Dynamic Range, SFDR to Nyquist	$f_{CLK} = 125MSPS$, $f_{OUT} = 32.9MHz$, 62.5MHz Span (Notes 4, 7)	-	54	-	dBc
	$f_{CLK} = 125MSPS$, $f_{OUT} = 10.1MHz$, 62.5MHz Span (Notes 4, 7)	-	64	-	dBc
	$f_{CLK} = 100MSPS$, $f_{OUT} = 40.4MHz$, 50MHz Span (Notes 4, 7)	-	52	-	dBc
	$f_{CLK} = 100MSPS$, $f_{OUT} = 20.2MHz$, 50MHz Span (Notes 4, 7)	-	60	-	dBc
	$f_{CLK} = 100MSPS$, $f_{OUT} = 5.04MHz$, 50MHz Span (Notes 4, 7)	-	68	-	dBc
	$f_{CLK} = 100MSPS$, $f_{OUT} = 2.51MHz$, 50MHz Span (Notes 4, 7)	-	74	-	dBc
	$f_{CLK} = 60MSPS$, $f_{OUT} = 10.1MHz$, 30MHz Span (Notes 4, 7)	-	63	-	dBc
	$f_{CLK} = 50MSPS$, $f_{OUT} = 20.2MHz$, 25MHz Span (Notes 4, 7)	-	55	-	dBc
	$f_{CLK} = 50MSPS$, $f_{OUT} = 5.02MHz$, 25MHz Span (Notes 4, 7)	-	68	-	dBc
	$f_{CLK} = 50MSPS$, $f_{OUT} = 2.51MHz$, 25MHz Span (Notes 4, 7)	-	73	-	dBc
	$f_{CLK} = 50MSPS$, $f_{OUT} = 1.00MHz$, 25MHz Span (Notes 4, 7)	-	73	-	dBc
AC CHARACTERISTICS - HI5760/6IB, HI5760/6IA - 60MHz					
Spurious Free Dynamic Range, SFDR Within a Window	$f_{CLK} = 60MSPS$, $f_{OUT} = 10.1MHz$, 10MHz Span (Notes 4, 7)	-	75	-	dBc
	$f_{CLK} = 50MSPS$, $f_{OUT} = 5.02MHz$, 2MHz Span (Notes 4, 7)	-	76	-	dBc
	$f_{CLK} = 50MSPS$, $f_{OUT} = 1.00MHz$, 2MHz Span (Notes 4, 7)	-	78	-	dBc
Total Harmonic Distortion (THD) to Nyquist	$f_{CLK} = 50MSPS$, $f_{OUT} = 2.00MHz$ (Notes 4, 7)	-	71	-	dBc
	$f_{CLK} = 50MSPS$, $f_{OUT} = 1.00MHz$ (Notes 4, 7)	-	76	-	dBc
Spurious Free Dynamic Range, SFDR to Nyquist	$f_{CLK} = 60MSPS$, $f_{OUT} = 20.2MHz$, 30MHz Span (Notes 4, 7)	-	56	-	dBc
	$f_{CLK} = 60MSPS$, $f_{OUT} = 10.1MHz$, 30MHz Span (Notes 4, 7)	-	63	-	dBc
	$f_{CLK} = 50MSPS$, $f_{OUT} = 20.2MHz$, 25MHz Span (Notes 4, 7)	-	55	-	dBc
	$f_{CLK} = 50MSPS$, $f_{OUT} = 5.02MHz$, 25MHz Span (Notes 4, 7)	-	68	-	dBc
	$f_{CLK} = 50MSPS$, $f_{OUT} = 2.51MHz$, 25MHz Span (Notes 4, 7)	-	73	-	dBc
	$f_{CLK} = 50MSPS$, $f_{OUT} = 1.00MHz$, 25MHz Span (Notes 4, 7)	-	73	-	dBc
	$f_{CLK} = 25MSPS$, $f_{OUT} = 5.02MHz$, 25MHz Span (Notes 4, 7)	-	71	-	dBc
VOLTAGE REFERENCE					
Internal Reference Voltage, V_{FSADJ}	Pin 18 Voltage with Internal Reference	1.04	1.16	1.28	V
Internal Reference Voltage Drift		-	± 60	-	ppm/ $^{\circ}C$
Internal Reference Output Current Sink/Source Capability		-	0.1	-	μA
Reference Input Impedance		-	1	-	$M\Omega$
Reference Input Multiplying Bandwidth	(Note 7)	-	1.4	-	MHz

HI5760

Electrical Specifications $AV_{DD} = DV_{DD} = +5V$, $V_{REF} = \text{Internal } 1.2V$, $I_{OUTFS} = 20mA$, $T_A = 25^{\circ}C$ for All Typical Values **(Continued)**

PARAMETER	TEST CONDITIONS	HI5760 $T_A = -40^{\circ}C \text{ TO } 85^{\circ}C$			UNITS
		MIN	TYP	MAX	
DIGITAL INPUTS D9-D0, CLK					
Input Logic High Voltage with 5V Supply, V_{IH}	(Note 3)	3.5	5	-	V
Input Logic High Voltage with 3V Supply, V_{IH}	(Note 3)	2.1	3	-	V
Input Logic Low Voltage with 5V Supply, V_{IL}	(Note 3)	-	0	1.3	V
Input Logic Low Voltage with 3V Supply, V_{IL}	(Note 3)	-	0	0.9	V
Input Logic Current, I_{IH}		-10	-	+10	μA
Input Logic Current, I_{IL}		-10	-	+10	μA
Digital Input Capacitance, C_{IN}		-	5	-	pF
TIMING CHARACTERISTICS					
Data Setup Time, t_{SU}	See Figure 41 (Note 3)	3	-	-	ns
Data Hold Time, t_{HLD}	See Figure 41 (Note 3)	3	-	-	ns
Propagation Delay Time, t_{PD}	See Figure 41	-	1	-	ns
CLK Pulse Width, t_{PW1} , t_{PW2}	See Figure 41 (Note 3)	4	-	-	ns
POWER SUPPLY CHARACTERISTICS					
AV_{DD} Power Supply	(Note 8)	2.7	5.0	5.5	V
DV_{DD} Power Supply	(Note 8)	2.7	5.0	5.5	V
Analog Supply Current (I_{AVDD})	(5V or 3V, $I_{OUTFS} = 20mA$)	-	23	30	mA
	(5V or 3V, $I_{OUTFS} = 2mA$)	-	4	-	mA
Digital Supply Current (I_{DVDD})	(5V, $I_{OUTFS} = \text{Don't Care}$) (Note 5)	-	3	5	mA
	(3V, $I_{OUTFS} = \text{Don't Care}$) (Note 5)	-	1.5	-	mA
Supply Current (I_{AVDD}) Sleep Mode	(5V or 3V, $I_{OUTFS} = \text{Don't Care}$)	-	1.6	3	mA
Power Dissipation	(5V, $I_{OUTFS} = 20mA$) (Note 6)	-	165	-	mW
	(5V, $I_{OUTFS} = 2mA$) (Note 6)	-	70	-	mW
	(5V, $I_{OUTFS} = 20mA$) (Note 9)	-	150	-	mW
	(3.3V, $I_{OUTFS} = 20mA$) (Note 9)	-	75	-	mW
	(3V, $I_{OUTFS} = 20mA$) (Note 6)	-	85	-	mW
	(3V, $I_{OUTFS} = 20mA$) (Note 9)	-	67	-	mW
	(3V, $I_{OUTFS} = 2mA$) (Note 6)	-	27	-	mW
Power Supply Rejection	Single Supply (Note 7)	-0.2	-	+0.2	% FSR/V

NOTES:

- Gain Error measured as the error in the ratio between the full scale output current and the current through R_{SET} (typically $625\mu A$). Ideally the ratio should be 31.969.
- Parameter guaranteed by design or characterization and not production tested.
- Spectral measurements made with differential coupled transformer.
- Measured with the clock at 50MSPS and the output frequency at 1MHz.
- Measured with the clock at 100MSPS and the output frequency at 40MHz.
- See 'Definition of Specifications'.
- It is recommended that the output current be reduced to 12mA or less to maintain optimum performance for operation below 3V. DV_{DD} and AV_{DD} do not have to be equal.
- Measured with the clock at 60MSPS and the output frequency at 10MHz.

Typical Performance Curves, 5V Power Supply

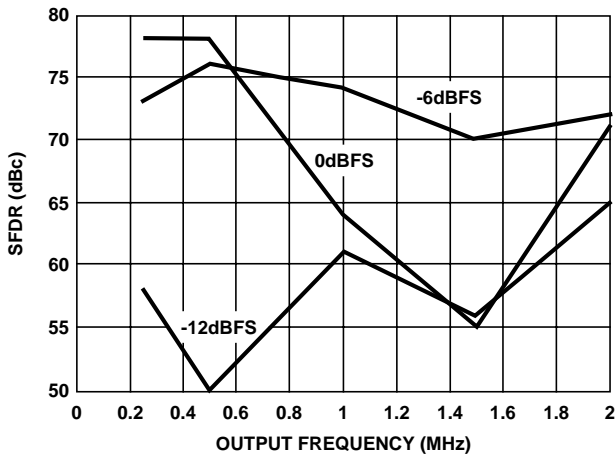

FIGURE 1. SFDR vs f_{OUT} , CLOCK = 5MSPS

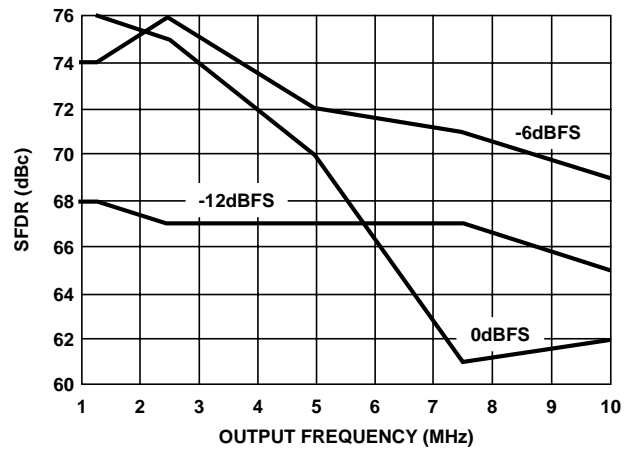

FIGURE 2. SFDR vs f_{OUT} , CLOCK = 25MSPS

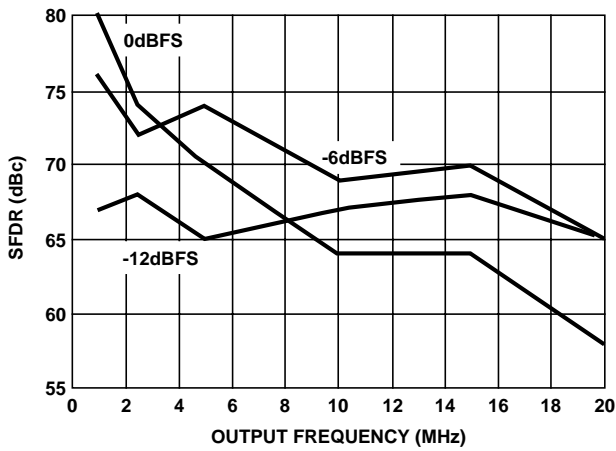

FIGURE 3. SFDR vs f_{OUT} , CLOCK = 50MSPS

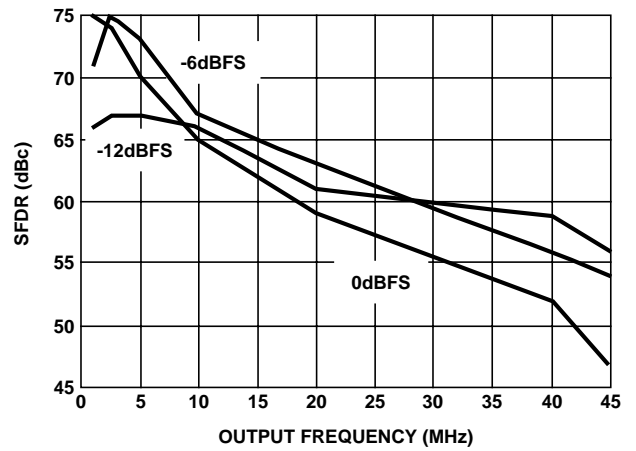

FIGURE 4. SFDR vs f_{OUT} , CLOCK = 100MSPS

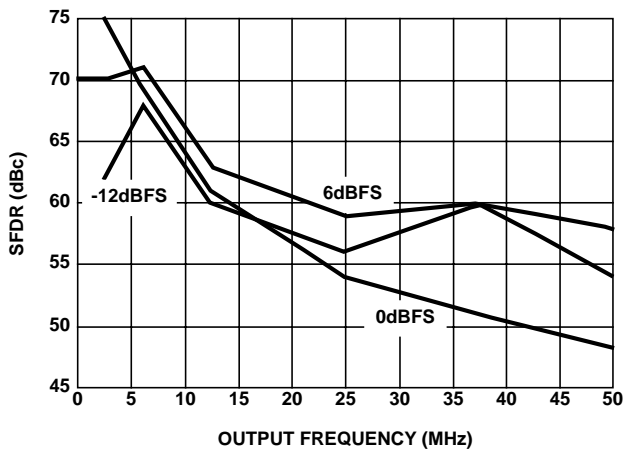

FIGURE 5. SFDR vs f_{OUT} , CLOCK = 125MSPS

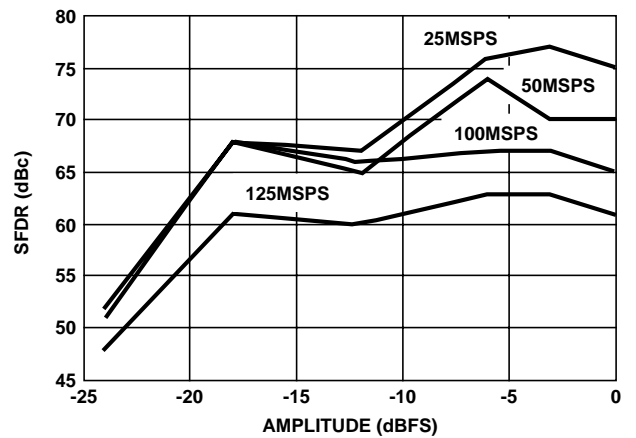

FIGURE 6. SFDR vs AMPLITUDE, $f_{CLK}/f_{OUT} = 10$

Typical Performance Curves, 5V Power Supply (Continued)

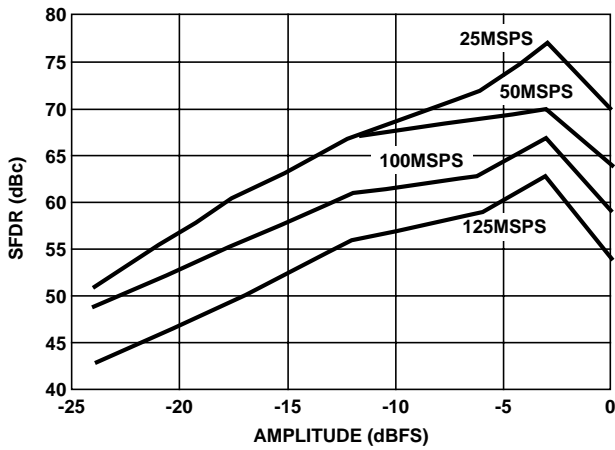

FIGURE 7. SFDR vs AMPLITUDE, $f_{CLK}/f_{OUT} = 5$

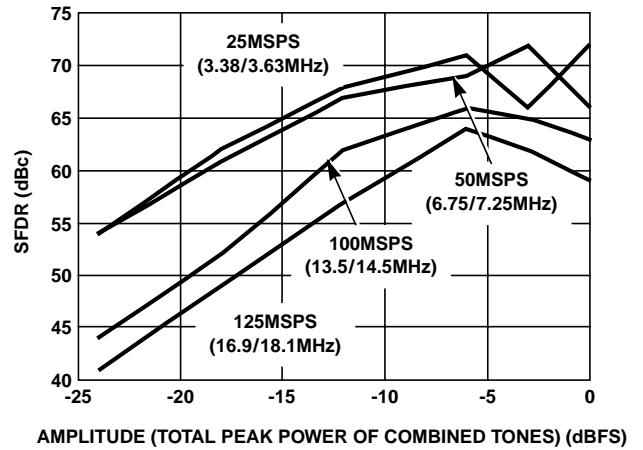

FIGURE 8. SFDR vs AMPLITUDE OF TWO TONES, $f_{CLK}/f_{OUT} = 7$

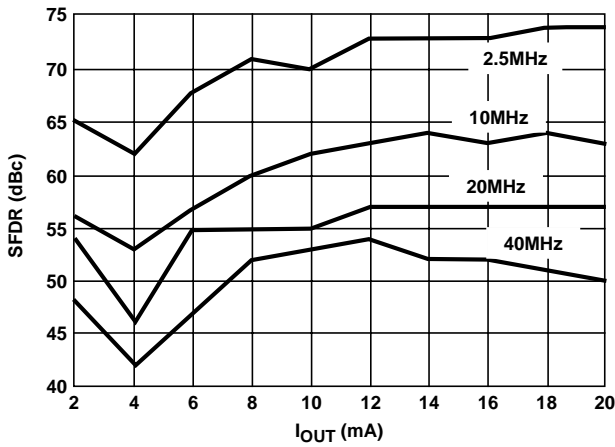

FIGURE 9. SFDR vs I_{OUT} , CLOCK = 100MSPS

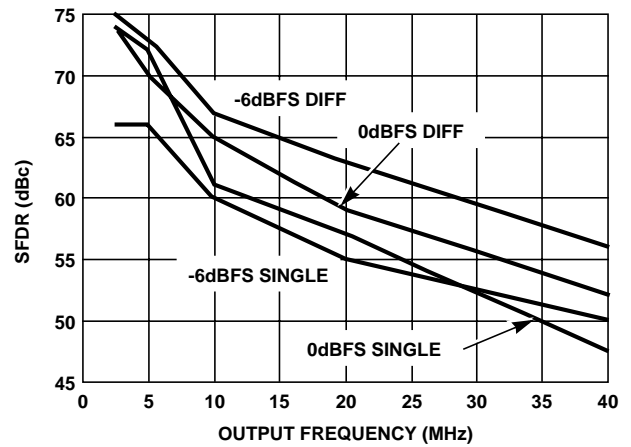

FIGURE 10. DIFFERENTIAL vs SINGLE-ENDED, CLOCK = 100MSPS

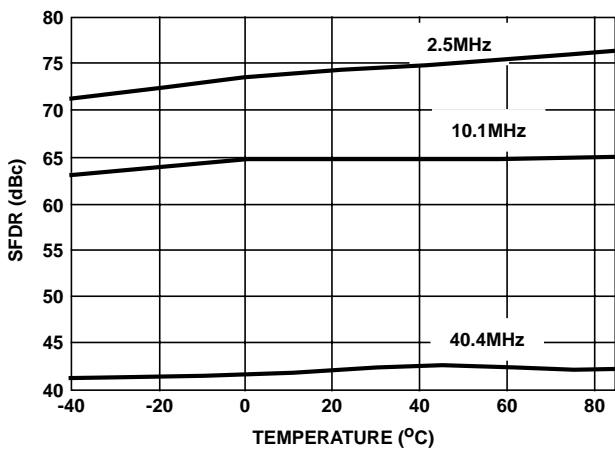

FIGURE 11. SFDR vs TEMPERATURE, CLOCK = 100MSPS

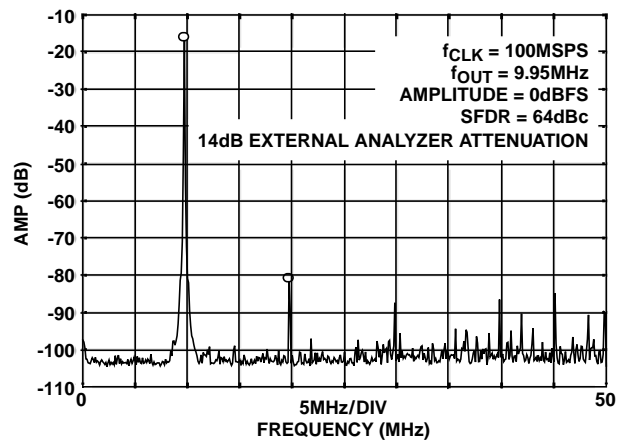

FIGURE 12. SINGLE TONE SFDR

Typical Performance Curves, 5V Power Supply (Continued)

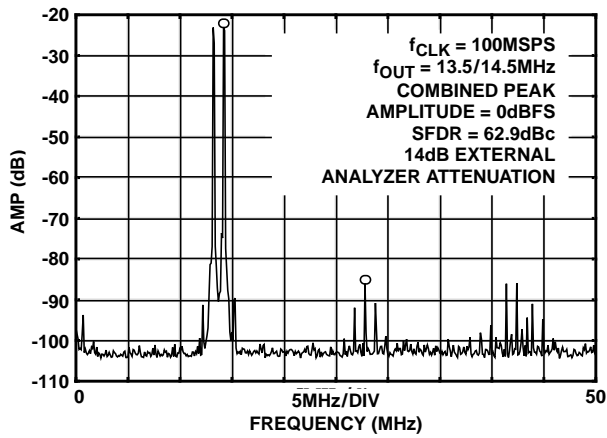

FIGURE 13. TWO-TONE, CLOCK = 100MSPS

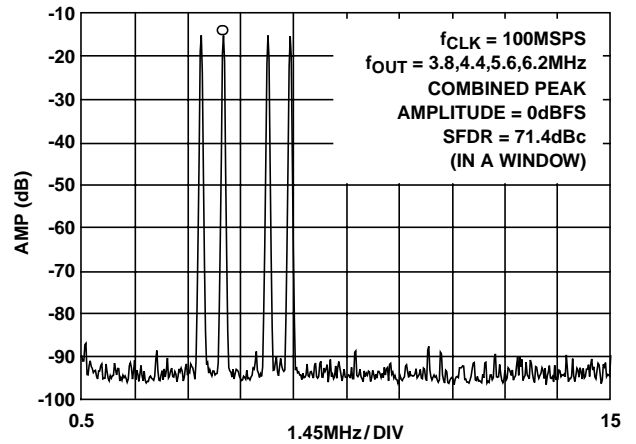

FIGURE 14. FOUR-TONE, CLOCK = 100MSPS

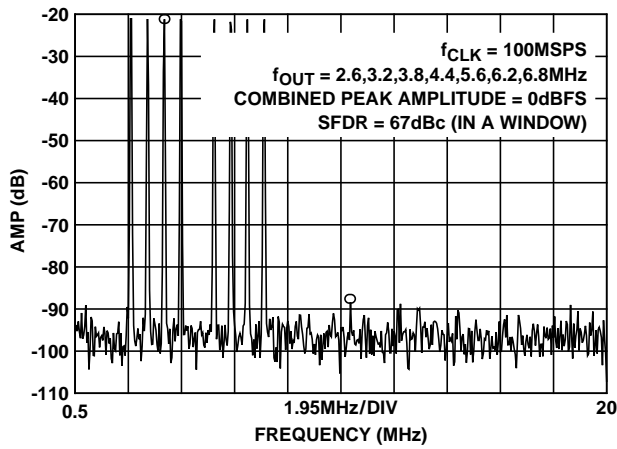

FIGURE 15. EIGHT-TONE, CLOCK = 100MSPS

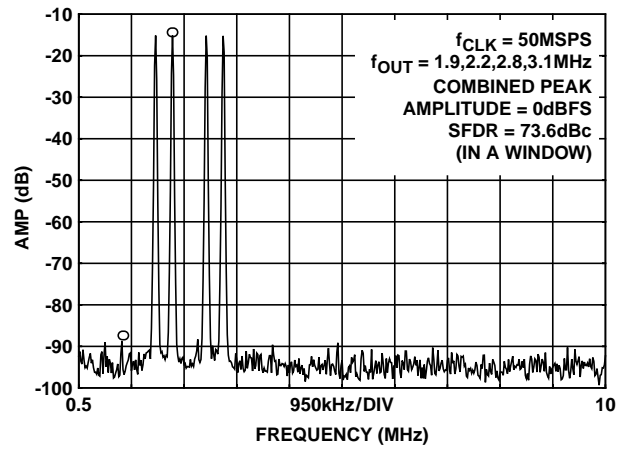

FIGURE 16. FOUR-TONE, CLOCK = 50MSPS

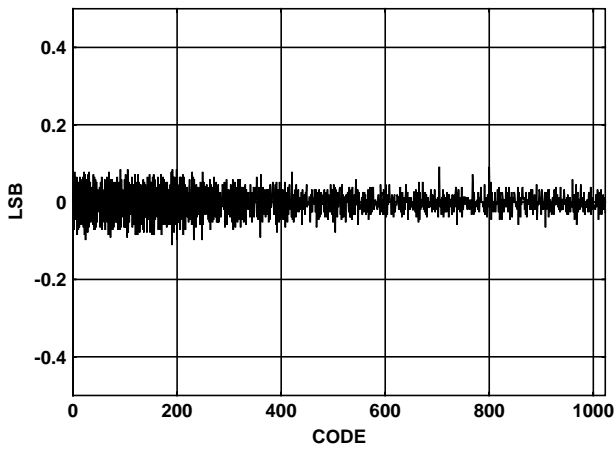

FIGURE 17. DIFFERENTIAL NONLINEARITY

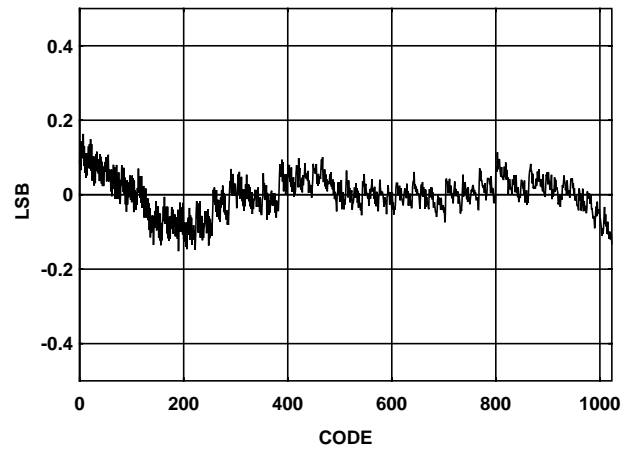

FIGURE 18. INTEGRAL NONLINEARITY

Typical Performance Curves, 5V Power Supply (Continued)

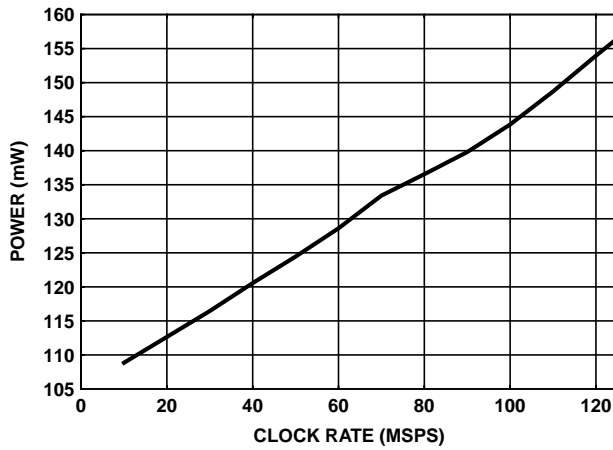

FIGURE 19. POWER vs CLOCK RATE, $f_{CLK}/f_{OUT} = 10$, $I_{OUT} = 20mA$

Typical Performance Curves, 3V Power Supply

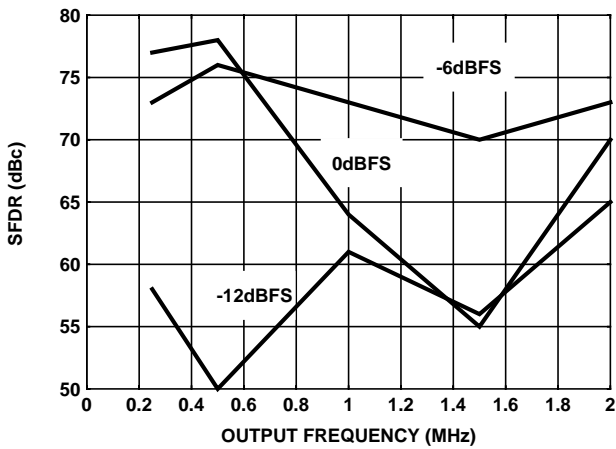

FIGURE 20. SFDR vs f_{OUT} , CLOCK = 5MSPS

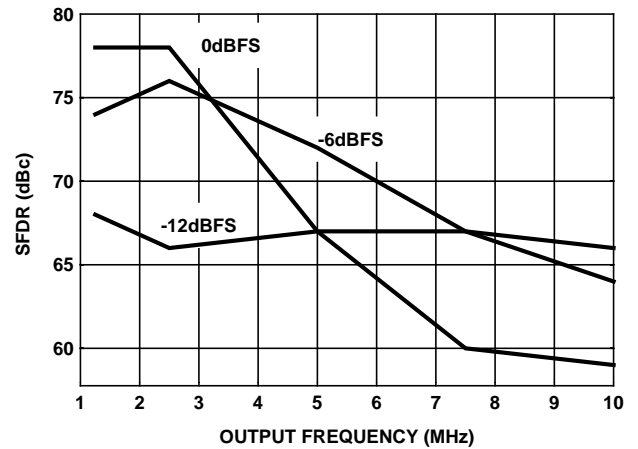

FIGURE 21. SFDR vs f_{OUT} , CLOCK = 25MSPS

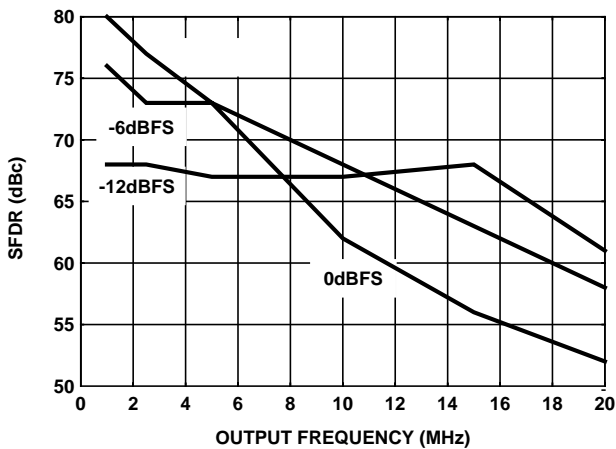

FIGURE 22. SFDR vs f_{OUT} , CLOCK = 50MSPS

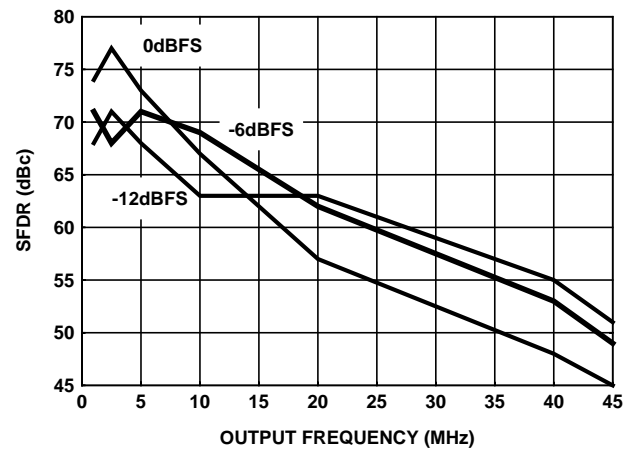

FIGURE 23. SFDR vs f_{OUT} , CLOCK = 100MSPS

Typical Performance Curves, 3V Power Supply (Continued)

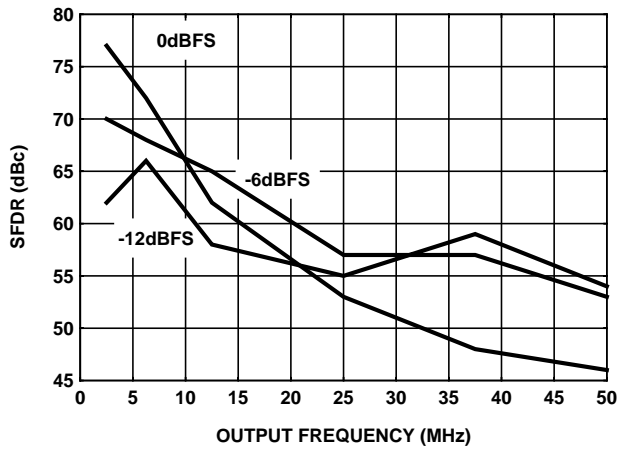

FIGURE 24. SFDR vs f_{OUT} , CLOCK = 125MSPS

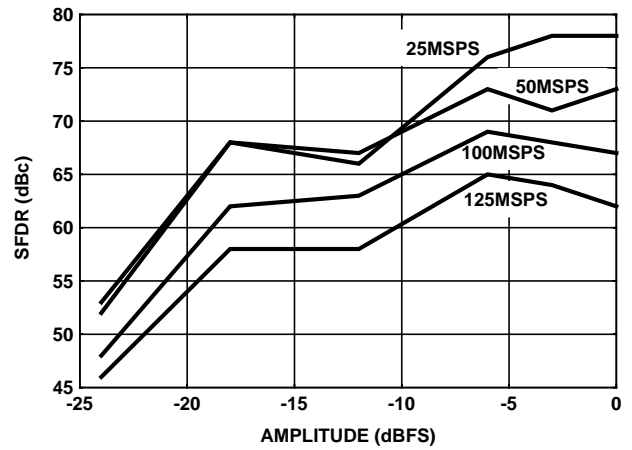

FIGURE 25. SFDR vs AMPLITUDE, $f_{CLK}/f_{OUT} = 10$

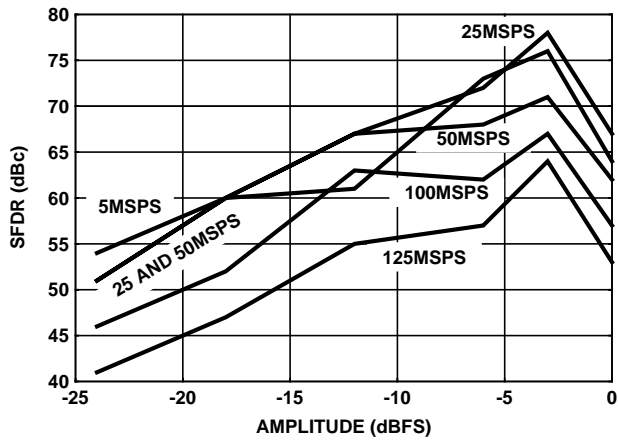

FIGURE 26. SFDR vs AMPLITUDE, $f_{CLK}/f_{OUT} = 5$

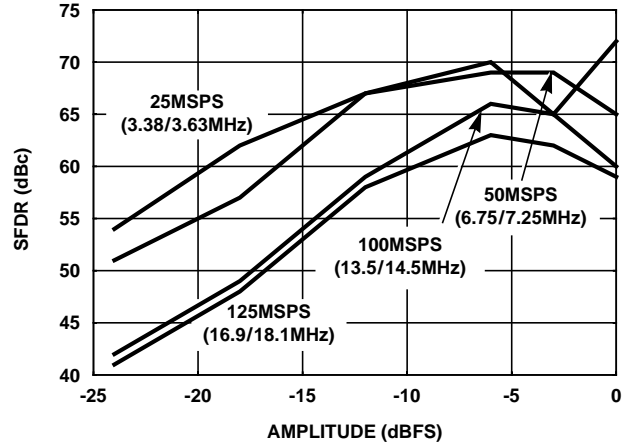

FIGURE 27. SFDR vs AMPLITUDE OF TWO TONES, $f_{CLK}/f_{OUT} = 7$

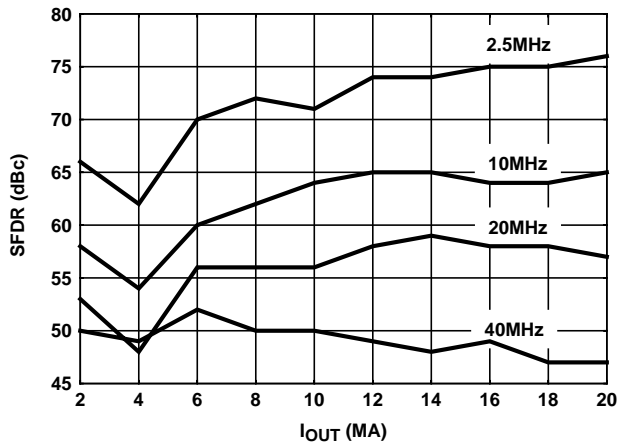

FIGURE 28. SFDR vs I_{OUT} , CLOCK = 100MSPS

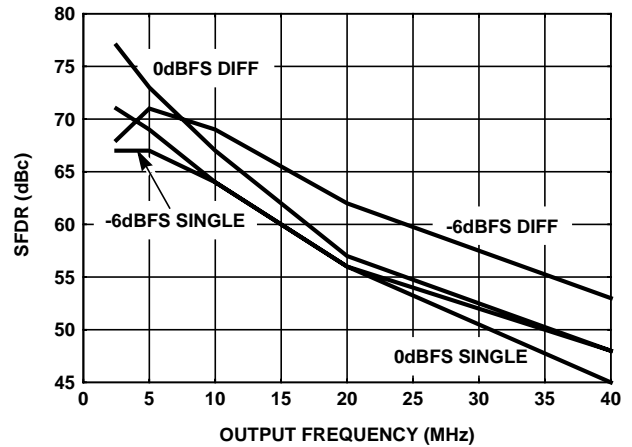

FIGURE 29. DIFFERENTIAL vs SINGLE-ENDED, CLOCK = 100MSPS

Typical Performance Curves, 3V Power Supply (Continued)

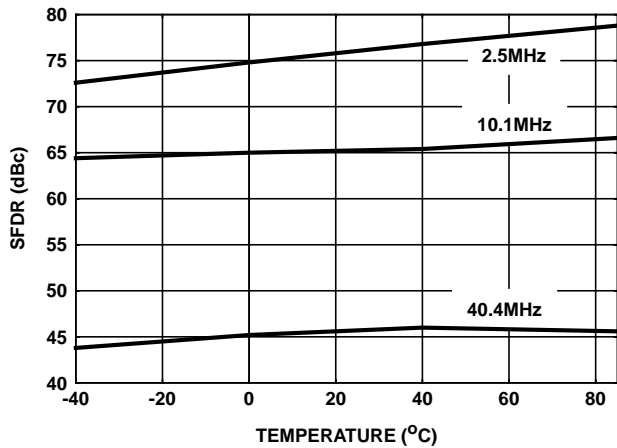

FIGURE 30. SFDR vs TEMPERATURE, CLOCK = 100MSPS

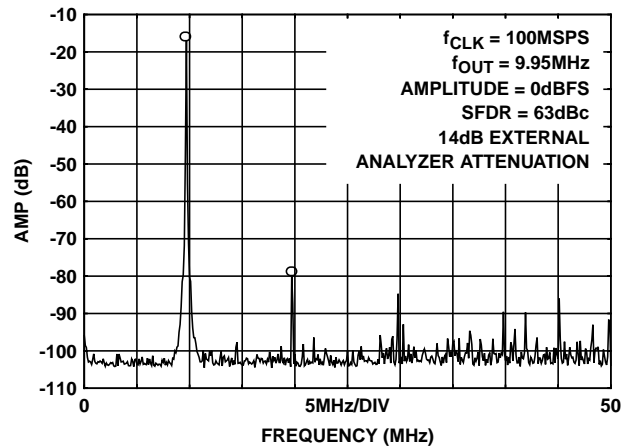

FIGURE 31. SINGLE TONE SFDR

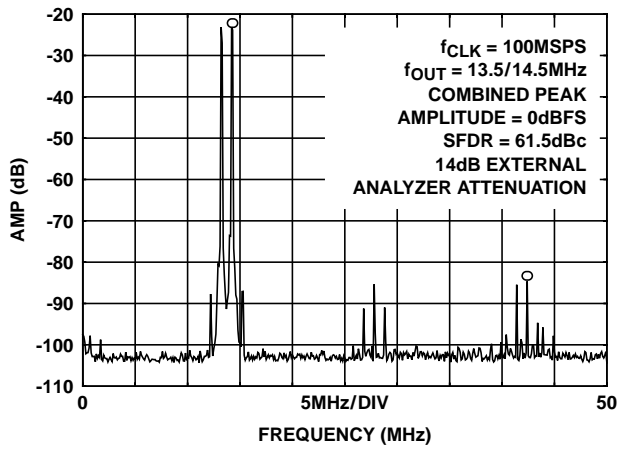

FIGURE 32. TWO-TONE, CLOCK = 100MSPS

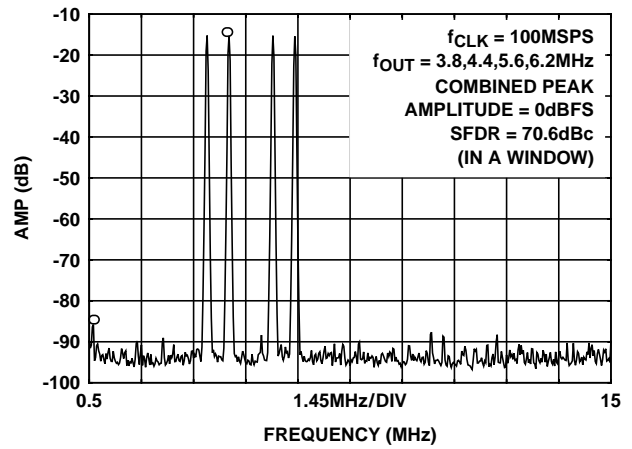

FIGURE 33. FOUR-TONE, CLOCK = 100MSPS

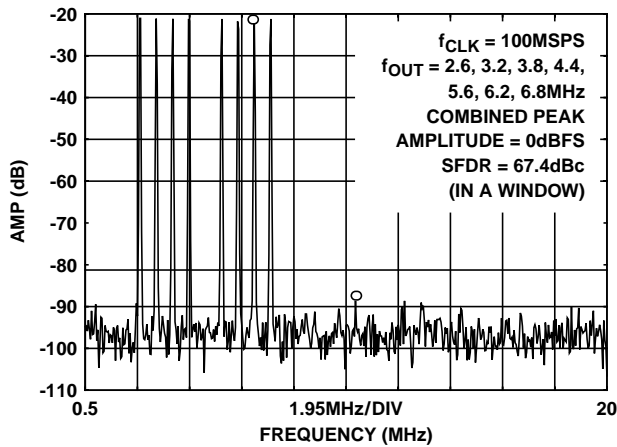

FIGURE 34. EIGHT-TONE, CLOCK = 100MSPS

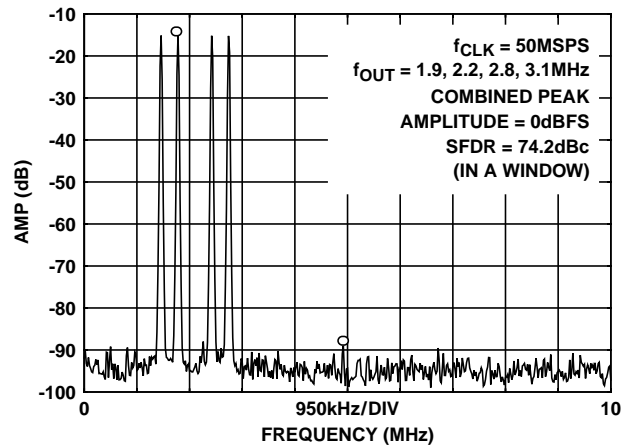

FIGURE 35. FOUR-TONE, CLOCK = 50MSPS

Typical Performance Curves, 3V Power Supply (Continued)

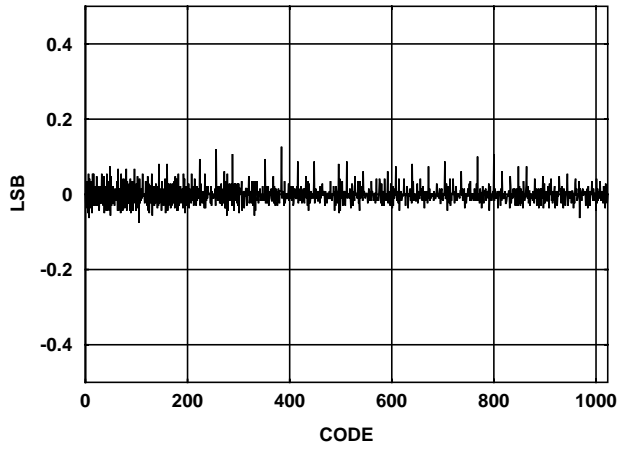

FIGURE 36. DIFFERENTIAL NONLINEARITY

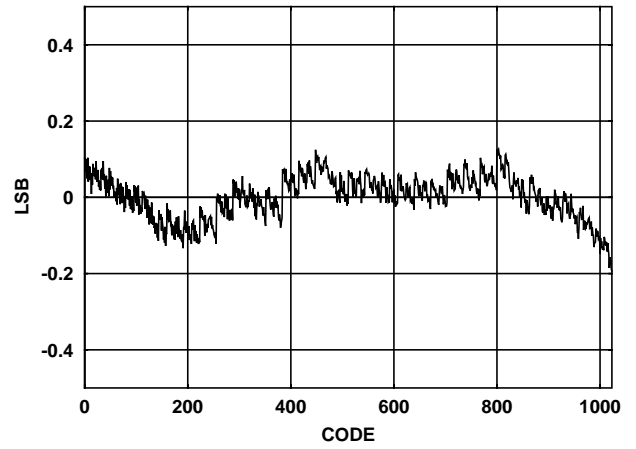

FIGURE 37. INTEGRAL NONLINEARITY

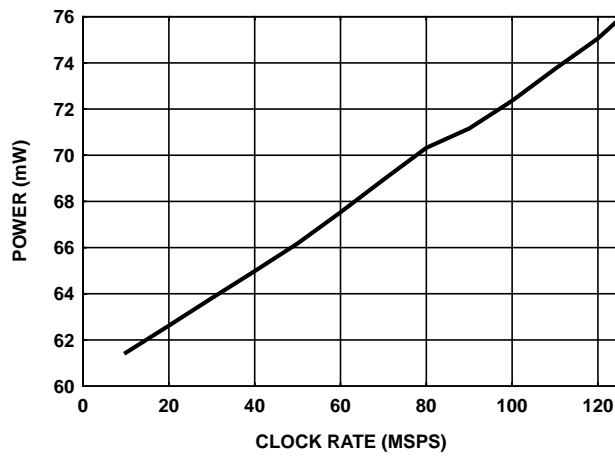

FIGURE 38. POWER vs CLOCK RATE, $f_{CLK}/f_{OUT} = 10$, $I_{OUT} = 20mA$

Timing Diagrams

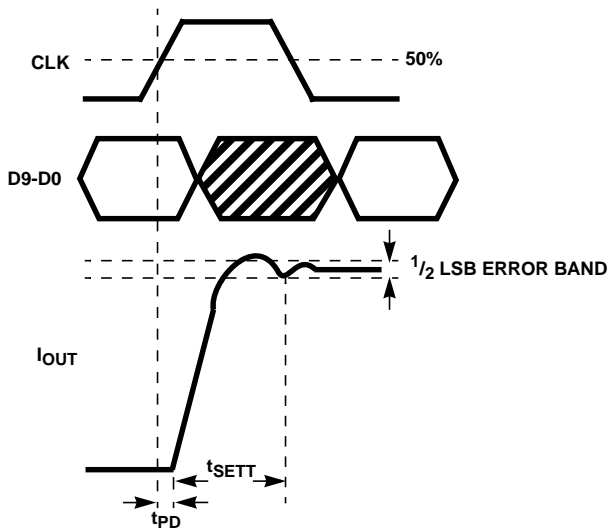

FIGURE 39. OUTPUT SETTLING TIME DIAGRAM

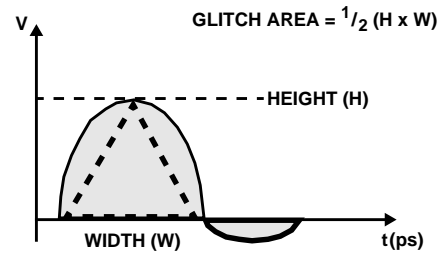

FIGURE 40. PEAK GLITCH AREA (SINGLET) MEASUREMENT METHOD

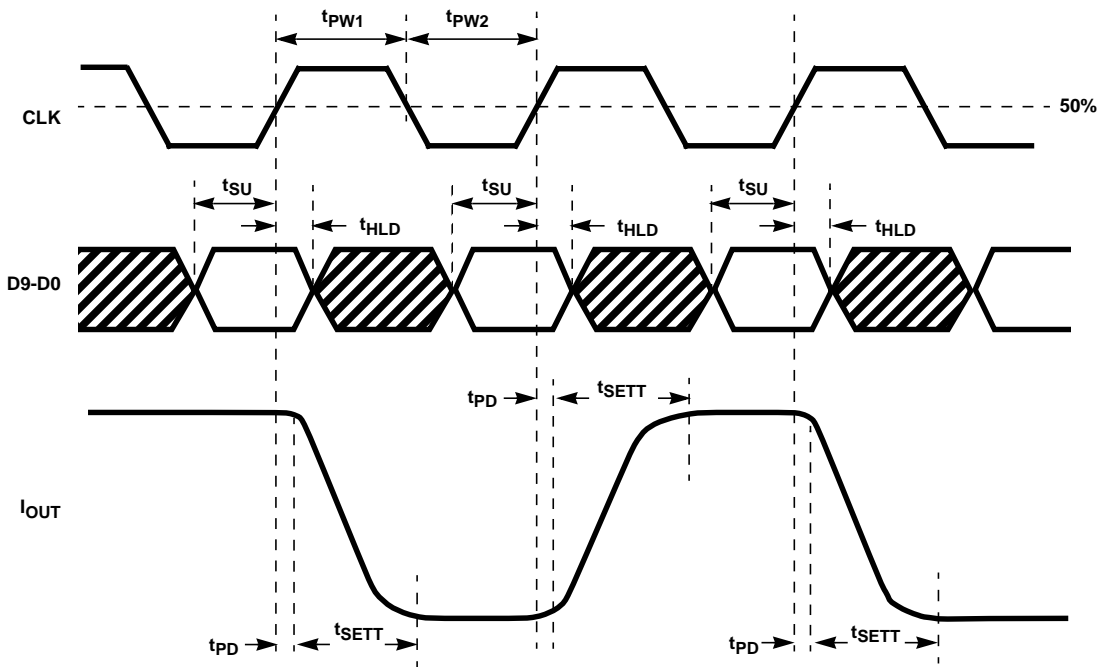

FIGURE 41. PROPAGATION DELAY, SETUP TIME, HOLD TIME AND MINIMUM PULSE WIDTH DIAGRAM

Definition of Specifications

Integral Linearity Error, INL, is the measure of the worst case point that deviates from a best fit straight line of data values along the transfer curve.

Differential Linearity Error, DNL, is the measure of the step size output deviation from code to code. Ideally the step size should be 1 LSB. A DNL specification of 1 LSB or less guarantees monotonicity.

Output Settling Time, is the time required for the output voltage to settle to within a specified error band measured from the beginning of the output transition. In the case of the HI5760, the measurement was done by switching from code 0 to 256, or quarter scale. Termination impedance was 25 Ω due to the parallel resistance of the output 50 Ω and the oscilloscope's 50 Ω input. This also aids the ability to resolve the specified error band without overdriving the oscilloscope.

Singlet Glitch Area, is the switching transient appearing on the output during a code transition. It is measured as the area under the overshoot portion of the curve and is expressed as a Volt-Time specification.

Full Scale Gain Error, is the error from an ideal ratio of 32 between the output current and the full scale adjust current (through R_{SET}).

Full Scale Gain Drift, is measured by setting the data inputs to all ones and measuring the output voltage through a known resistance as the temperature is varied from T_{MIN} to T_{MAX}. It is defined as the maximum *deviation* from the *value* measured at room temperature to the *value* measured at either T_{MIN} or T_{MAX}. The units are ppm of FSR (full scale range) per degree C.

Total Harmonic Distortion, THD, is the ratio of the DAC output fundamental to the RMS sum of the first five harmonics.

Spurious Free Dynamic Range, SFDR, is the amplitude difference from the fundamental to the largest harmonically or non-harmonically related spur within the specified window.

Output Voltage Compliance Range, is the voltage limit imposed on the output. The output impedance load should be chosen such that the voltage developed does not violate the compliance range.

Offset Error, is measured by setting the data inputs to all zeros and measuring the output voltage through a known resistance. Offset error is defined as the maximum *deviation* of the output current from a value of 0mA.

Offset Drift, is measured by setting the data inputs to all zeros and measuring the output voltage through a known resistance as the temperature is varied from T_{MIN} to T_{MAX}. It is defined as the maximum *deviation* from the *value* measured at room temperature to the *value* measured at

either T_{MIN} or T_{MAX}. The units are ppm of FSR (full scale range) per degree C.

Power Supply Rejection, is measured using a single power supply. Its nominal +5V is varied $\pm 10\%$ and the change in the DAC full scale output is noted.

Reference Input Multiplying Bandwidth, is defined as the 3dB bandwidth of the voltage reference input. It is measured by using a sinusoidal waveform as the external reference with the digital inputs set to all 1s. The frequency is increased until the amplitude of the output waveform is 0.707 of its original value.

Internal Reference Voltage Drift, is defined as the maximum *deviation* from the *value* measured at room temperature to the *value* measured at either T_{min} or T_{max}. The units are ppm per degree C.

Detailed Description

The HI5760 is a 10-bit, current out, CMOS, digital to analog converter. Its maximum update rate is 125MSPS and can be powered by either single or dual power supplies in the recommended range of +3V to +5V. It consumes less than 165mW of power when using a +5V supply with the data switching at 100MSPS. The architecture is based on a segmented current source arrangement that reduces glitch by reducing the amount of current switching at any one time. The five MSBs are represented by 31 major current sources of equivalent current. The five LSBs are comprised of binary weighted current sources. Consider an input waveform to the converter which is ramped through all the codes from 0 to 1023. The five LSB current sources would begin to count up. When they reached the all high state (decimal value of 31) and needed to count to the next code, they would all turn off and the first major current source would turn on. To continue counting upward, the 5 LSBs would count up another 31 codes, and then the next major current source would turn on and the five LSBs would all turn off. The process of the single, equivalent, major current source turning on and the five LSBs turning off each time the converter reaches another 31 codes greatly reduces the glitch at any one switching point. In previous architectures that contained all binary weighted current sources or a binary weighted resistor ladder, the converter might have a substantially larger amount of current turning on and off at certain, worst-case transition points such as mid-scale and quarter scale transitions. By greatly reducing the amount of current switching at certain 'major' transitions, the overall glitch of the converter is dramatically reduced, improving settling times and transient problems.

Digital Inputs and Termination

The HI5760 digital inputs are guaranteed to CMOS levels. However, TTL compatibility can be achieved by lowering the supply voltage to 3V due to the digital threshold of the input buffer being approximately half of the supply voltage. The internal register is updated on the rising edge of the clock. To minimize reflections, proper termination should be implemented. If the lines driving the clock and the digital inputs are 50Ω lines, then 50Ω termination resistors should be placed as close to the converter inputs as possible to the digital ground plane (if separate grounds are used).

Ground Plane(s)

If separate digital and analog ground planes are used, then all of the digital functions of the device and their corresponding components should be over the digital ground plane and terminated to the digital ground plane. The same is true for the analog components and the analog ground plane. The converter will function properly with a single ground plane, as the Evaluation Board is configured in this matter. Refer to the AppNote on the HI5760 Evaluation Board for further discussion of the ground plane(s) upon availability.

Noise Reduction

To minimize power supply noise, 0.1μF capacitors should be placed as close as possible to the converter’s power supply pins, AV_{DD} and DV_{DD}. Also, should the layout be designed using separate digital and analog ground planes, these capacitors should be terminated to the digital ground for DV_{DD} and to the analog ground for AV_{DD}. Additional filtering of the power supplies on the board is recommended. See the AppNote on the HI5760 Evaluation Board for more information upon availability.

Voltage Reference

The internal voltage reference of the device has a nominal value of +1.2V with a ±60 ppm/°C drift coefficient over the full temperature range of the converter. It is recommended that a 0.1μF capacitor be placed as close as possible to the REFIO pin, connected to the analog ground. The REFLO pin (16) selects the reference. The internal reference can be selected if pin 16 is tied low (ground). If an external reference is desired, then pin 16 should be tied high (to the analog supply voltage) and the external reference driven into REFIO, pin 17. The full scale output current of the converter is a function of the voltage reference used and the value of R_{SET}. I_{OUT} should be within the 2mA to 20mA range, through operation below 2mA is possible, with performance degradation.

If the internal reference is used, V_{FSADJ} will equal approximately 1.16V (pin 18). If an external reference is used, V_{FSADJ} will equal the external reference. The calculation for I_{OUT} (Full Scale) is:

$$I_{OUT} \text{ (Full Scale)} = (V_{FSADJ}/R_{SET}) \times 32.$$

If the full scale output current is set to 20mA by using the internal voltage reference (1.16V) and a 1.86kΩ R_{SET} resistor, then the input coding to output current will resemble the following:

TABLE 1. INPUT CODING vs OUTPUT CURRENT

INPUT CODE (D9-D0)	IOUTA (mA)	IOUTB (mA)
11111 11111	20	0
10000 00000	10	10
00000 00000	0	20

Outputs

IOUTA and IOUTB are complementary current outputs. The sum of the two currents is always equal to the full scale output current minus one LSB. If single ended use is desired, a load resistor can be used to convert the output current to a voltage. It is recommended that the unused output be either grounded or equally terminated. The voltage developed at the output must not violate the output voltage compliance range of -0.3V to 1.25V. R_{LOAD} should be chosen so that the desired output voltage is produced in conjunction with the output full scale current, which is described above in the ‘Reference’ section. If a known line impedance is to be driven, then the output load resistor should be chosen to match this impedance. The output voltage equation is:

$$V_{OUT} = I_{OUT} \times R_{LOAD}.$$

These outputs can be used in a differential-to-single-ended arrangement to achieve better harmonic rejection. The SFDR measurements in this data sheet were performed with a 1:1 transformer on the output of the DAC (see Figure 1). With the center tap grounded, the output swing of pins 21 and 22 will be biased at zero volts. It is important to note here that the negative voltage output compliance range limit is -300mV, imposing a maximum of 600mV_{P-P} amplitude with this configuration. The loading as shown in Figure 1 will result in a 500mV signal at the output of the transformer if the full scale output current of the DAC is set to 20mA.

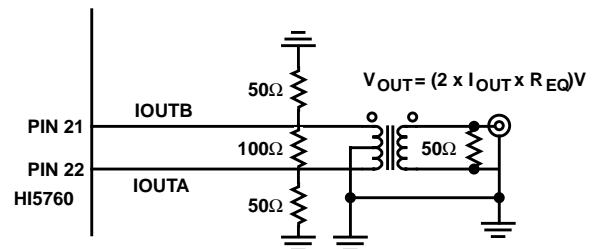

FIGURE 42.

$$V_{OUT} = 2 \times I_{OUT} \times R_{EQ}, \text{ where } R_{EQ} \text{ is } \sim 12.5\Omega.$$

Pin Descriptions

PIN NO.	PIN NAME	PIN DESCRIPTION
1-10	D9 (MSB) Through D0 (LSB)	Digital Data Bit 9, (Most Significant Bit) through Digital Data Bit 0, (Least Significant Bit).
11-14	NC	No Connect. Recommend ground.
15	SLEEP	Control Pin for Power-Down mode. Sleep Mode is active high; Connect to ground for Normal Mode. Sleep pin has internal 20 μ A active pulldown current.
16	REFLO	Connect to analog ground to enable internal 1.2V reference or connect to AV _{DD} to disable internal reference.
17	REFIO	Reference voltage input if internal reference is disabled. Reference voltage output if internal reference is enabled. Use 0.1 μ F cap to ground when internal reference is enabled.
18	FSADJ	Full Scale Current Adjust. Use a resistor to ground to adjust full scale output current. Full Scale Output Current = $32 \times V_{FSADJ}/R_{SET}$.
19	COMP1	For use in reducing bandwidth/noise. Recommended: connect 0.1 μ F to AV _{DD} .
20	ACOM	Analog Ground.
21	IOUTB	The complimentary current output of the device. Full scale output current is achieved when all input bits are set to binary 0.
22	IOUTA	Current output of the device. Full scale output current is achieved when all input bits are set to binary 1.
23	NC	Internally connected to ACOM via a resistor. Recommend leave disconnected. Adding a capacitor to ACOM for upward compatibility is valid. Grounding to ACOM is valid. (For upward compatibility to 12-bit and 14-bit devices, pin 23 needs the ability to have a 0.1 μ F capacitor to ACOM.)
24	AV _{DD}	Analog Supply (+3V to +5V).
25	NC	No Connect. (For upward compatibility to 12 and 14b devices, pin 25 needs to be grounded to ACOM.)
26	DCOM	Digital Ground.
27	DV _{DD}	Digital Supply (+3V to +5V).
28	CLK	Input for clock. Positive edge of clock latches data.

Small Outline Plastic Packages (SOIC)

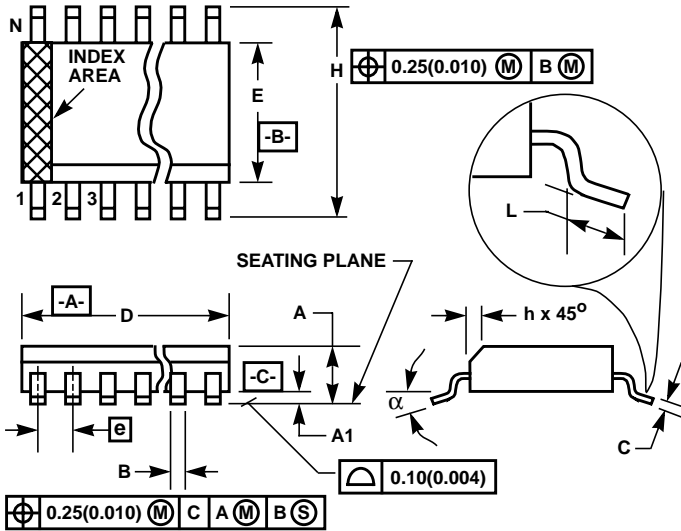

M28.3 (JEDEC MS-013-AE ISSUE C)
28 LEAD WIDE BODY SMALL OUTLINE PLASTIC PACKAGE

SYMBOL	INCHES		MILLIMETERS		NOTES
	MIN	MAX	MIN	MAX	
A	0.0926	0.1043	2.35	2.65	-
A1	0.0040	0.0118	0.10	0.30	-
B	0.013	0.0200	0.33	0.51	9
C	0.0091	0.0125	0.23	0.32	-
D	0.6969	0.7125	17.70	18.10	3
E	0.2914	0.2992	7.40	7.60	4
e	0.05 BSC		1.27 BSC		-
H	0.394	0.419	10.00	10.65	-
h	0.01	0.029	0.25	0.75	5
L	0.016	0.050	0.40	1.27	6
N	28		28		7
α	0°	8°	0°	8°	-

NOTES:

1. Symbols are defined in the "MO Series Symbol List" in Section 2.2 of Publication Number 95.
2. Dimensioning and tolerancing per ANSI Y14.5M-1982.
3. Dimension "D" does not include mold flash, protrusions or gate burrs. Mold flash, protrusion and gate burrs shall not exceed 0.15mm (0.006 inch) per side.
4. Dimension "E" does not include interlead flash or protrusions. Interlead flash and protrusions shall not exceed 0.25mm (0.010 inch) per side.
5. The chamfer on the body is optional. If it is not present, a visual index feature must be located within the crosshatched area.
6. "L" is the length of terminal for soldering to a substrate.
7. "N" is the number of terminal positions.
8. Terminal numbers are shown for reference only.
9. The lead width "B", as measured 0.36mm (0.014 inch) or greater above the seating plane, shall not exceed a maximum value of 0.61mm (0.024 inch)
10. Controlling dimension: MILLIMETER. Converted inch dimensions are not necessarily exact.

Rev. 0 12/93

Thin Shrink Small Outline Plastic Packages (TSSOP)

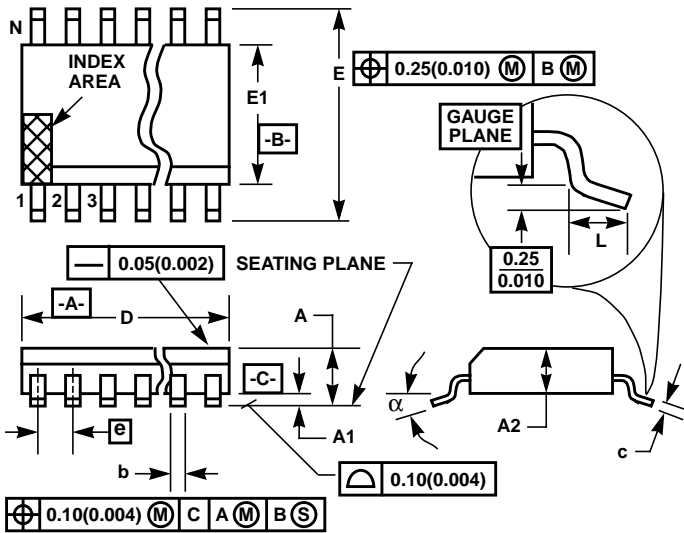

M28.173
28 LEAD THIN SHRINK SMALL OUTLINE PLASTIC PACKAGE

SYMBOL	INCHES		MILLIMETERS		NOTES
	MIN	MAX	MIN	MAX	
A	-	0.047	-	1.20	-
A1	0.002	0.006	0.05	0.15	-
A2	0.031	0.051	0.80	1.05	-
b	0.0075	0.0118	0.19	0.30	9
c	0.0035	0.0079	0.09	0.20	-
D	0.378	0.386	9.60	9.80	3
E1	0.169	0.177	4.30	4.50	4
e	0.026 BSC		0.65 BSC		-
E	0.246	0.256	6.25	6.50	-
L	0.0177	0.0295	0.45	0.75	6
N	28		28		7
α	0°	8°	0°	8°	-

NOTES:

- These package dimensions are within allowable dimensions of JEDEC MO-153-AE, Issue E.
- Dimensioning and tolerancing per ANSI Y14.5M-1982.
- Dimension "D" does not include mold flash, protrusions or gate burrs. Mold flash, protrusion and gate burrs shall not exceed 0.15mm (0.006 inch) per side.
- Dimension "E1" does not include interlead flash or protrusions. Interlead flash and protrusions shall not exceed 0.15mm (0.006 inch) per side.
- The chamfer on the body is optional. If it is not present, a visual index feature must be located within the crosshatched area.
- "L" is the length of terminal for soldering to a substrate.
- "N" is the number of terminal positions.
- Terminal numbers are shown for reference only.
- Dimension "b" does not include dambar protrusion. Allowable dambar protrusion shall be 0.08mm (0.003 inch) total in excess of "b" dimension at maximum material condition. Minimum space between protrusion and adjacent lead is 0.07mm (0.0027 inch).
- Controlling dimension: MILLIMETER. Converted inch dimensions are not necessarily exact. (Angles in degrees)

Rev. 0 6/98

All Intersil semiconductor products are manufactured, assembled and tested under **ISO9000** quality systems certification.

Intersil semiconductor products are sold by description only. Intersil Corporation reserves the right to make changes in circuit design and/or specifications at any time without notice. Accordingly, the reader is cautioned to verify that data sheets are current before placing orders. Information furnished by Intersil is believed to be accurate and reliable. However, no responsibility is assumed by Intersil or its subsidiaries for its use; nor for any infringements of patents or other rights of third parties which may result from its use. No license is granted by implication or otherwise under any patent or patent rights of Intersil or its subsidiaries.

For information regarding Intersil Corporation and its products, see web site www.intersil.com

Sales Office Headquarters

NORTH AMERICA
Intersil Corporation
P. O. Box 883, Mail Stop 53-204
Melbourne, FL 32902
TEL: (321) 724-7000
FAX: (321) 724-7240

EUROPE
Intersil SA
Mercure Center
100, Rue de la Fusee
1130 Brussels, Belgium
TEL: (32) 2.724.2111
FAX: (32) 2.724.22.05

ASIA
Intersil (Taiwan) Ltd.
7F-6, No. 101 Fu Hsing North Road
Taipei, Taiwan
Republic of China
TEL: (886) 2 2716 9310
FAX: (886) 2 2715 3029