

Agilent Subminiature High Performance TS AlGaAs Red LED Lamps Data Sheet

HLMP-P106/P156
HLMP-Q102/Q152
HLMP-Q106/Q156

Description

Flat Top Package

The HLMP-Pxxx Series flat top lamps use an untinted, non-diffused, truncated lens to provide a wide radiation pattern that is necessary for use in backlighting applications. The flat top lamps are also ideal for use as emitters in light pipe applications.

Dome Packages

The HLMP-Qxxx Series dome lamps, for use as indicators, use a tinted, diffused lens to provide a wide viewing angle with high on-off contrast ratio. High brightness lamps use an untinted, nondiffused lens to provide a high luminous intensity within a narrow radiation pattern.

Lead Configurations

All of these devices are made by encapsulating LED chips on axial lead frames to form molded epoxy subminiature lamp packages. A variety of package configuration options is

available. These include special surface mount lead configurations, gull wing, yoke lead, or Z-bend. Right angle lead bends at 2.54 mm (0.100 inch) and 5.08 mm (0.200 inch) center spacing are available for through hole mounting. For more information refer to Standard SMT and Through Hole Lead Bend Options for Subminiature LED Lamps data sheet.

Technology

These subminiature solid state lamps utilize a highly optimized LED material technology, transparent substrate aluminum gallium arsenide (TS AlGaAs). This LED technology has a very high luminous efficiency, capable of producing high light output over a wide range of drive currents (500 μ A to 50 mA). The color is deep red at a dominant wavelength of 644 nm deep red. TS AlGaAs is a flip-chip LED technology, die attached to the anode lead and wire bonded to the cathode lead. Available viewing angles are 75°, 35°, and 15°.

Features

- **Subminiature flat top package**
Ideal for backlighting and light piping applications
- **Subminiature dome package**
Diffused dome for wide viewing angle
Non-diffused dome for high brightness
- **Wide range of drive currents**
500 μ A to 50 mA
- **Ideal for space limited Applications**
- **Axial leads**
- **Available with lead configurations for surface mount and through hole PC board mounting**



Device Selection Guide

| Package Description | Viewing Angle $2 \theta_{1/2}$ | Deep Red $R_d = 644 \text{ nm}$ | Typical Iv $I_F = 500 \mu\text{A}$ | Typical Iv $I_F = 20 \text{ mA}$ | Package Outline |
|--|-----------------------------------|------------------------------------|---------------------------------------|-------------------------------------|-----------------|
| Domed, Diffused Tinted, Standard Current | 35 | HLMP-Q102 | | 100 | B |
| Domed, Diffused Tinted, Low Current | 35 | HLMP-Q152 | 2 | | B |
| Domed, Nondiffused Untinted, Standard Current | 15 | HLMP-Q106 | | 400 | B |
| Domed, Nondiffused Untinted, Low Current | 15 | HLMP-Q156 | 7 | | B |
| Flat Top, Nondiffused, Untinted, Standard Current | 75 | HLMP-P106 | | 130 | A |
| Flat Top, Nondiffused Untinted, Low Current | 75 | HLMP-P156 | 2 | | A |

Ordering Information

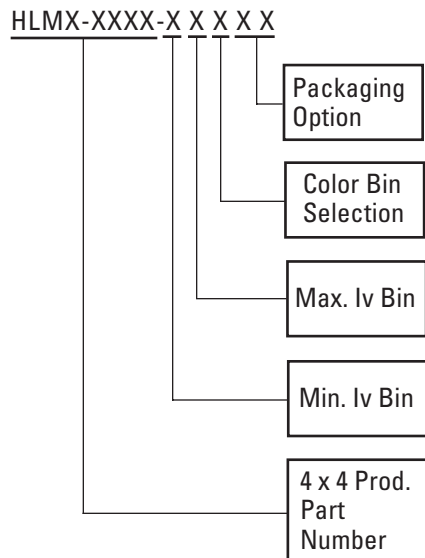

Package Dimensions

A) Flat Top Lamps

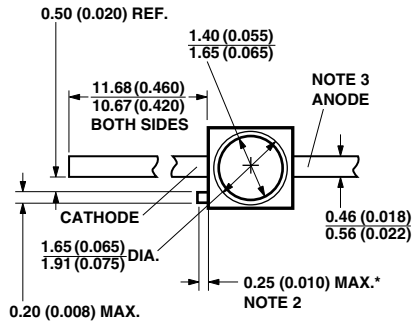

* REFER TO FIGURE 1 FOR DESIGN CONCERNS.

B) Diffused and Nondiffused Dome Lamps

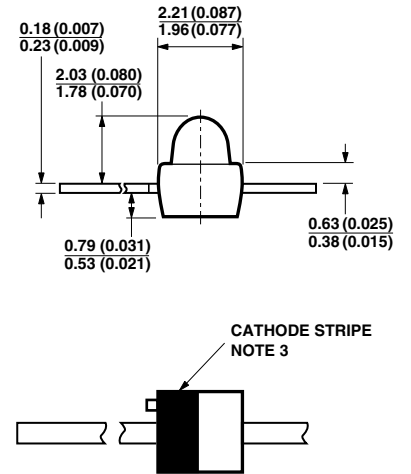
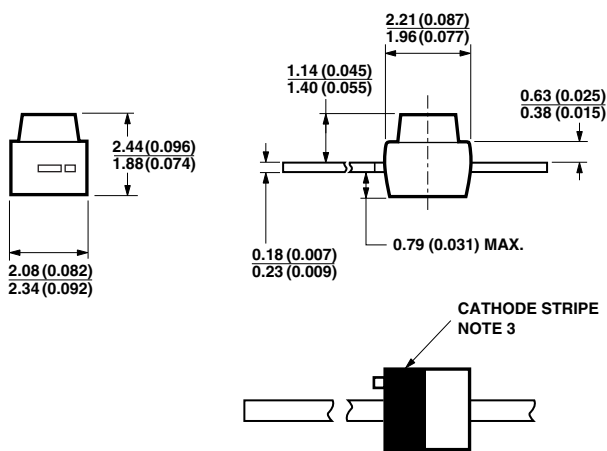
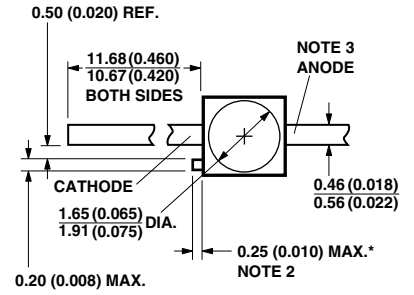

- NOTES:**
1. ALL DIMENSIONS ARE IN MILLIMETRES (INCHES).
 2. PROTRUDING SUPPORT TAB IS CONNECTED TO ANODE LEAD.
 3. LEAD POLARITY FOR THESE TS AlGaAs SUBMINIATURE LAMPS IS OPPOSITE TO THE LEAD POLARITY OF SUBMINIATURE LAMPS USING OTHER LED TECHNOLOGIES.

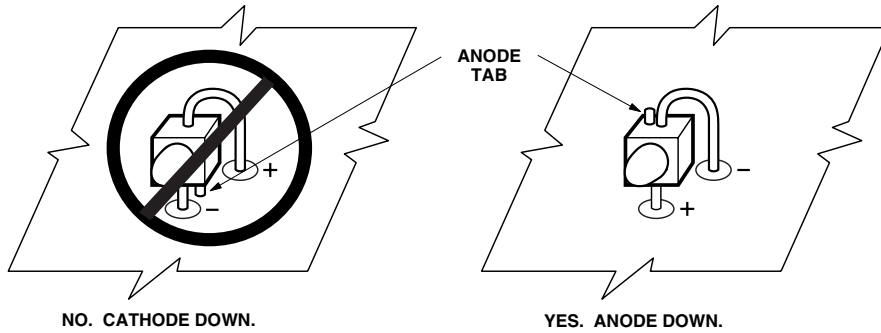

Figure 1. Proper right angle mounting to a PC board to prevent protruding anode tab from shorting to cathode connection.

Absolute Maximum Ratings at T_A = 25°C

| Parameters | Title |
|--|----------------------|
| DC Forward Current ^[1] | 50 mA |
| Peak Forward Current ^[2] | 300 mA |
| Average Forward Current ^[2,3] | 30 mA |
| Transient Forward Current (10 μs Pulse) ^[4] | 500 mA |
| Power Dissipation | 100 mW |
| Reverse Voltage | 5 V |
| Junction Temperature | 110°C |
| Operating Temperature | -55°C to +100°C |
| Storage Temperature | -55°C to +100°C |
| Lead Soldering Temperature [1.6 mm (0.063 in.) from body] | 260°C for 5 seconds |
| Reflow Soldering Temperature | 260°C for 20 seconds |

Notes:

- Derate linearly as shown in Figure 6.
- Refer to Figure 7 to establish pulsed operating conditions.
- Maximum I_{AVG} at f = 1 kHz, DF = 10%.
- The transient peak current is the maximum non-recurring peak current the device can withstand without damaging the LED die and wire bonds. It is not recommended that the device be operated at peak currents above the Absolute Maximum Peak Forward Current.

Optical Characteristics at T_A = 25°C

| Part Number HLMP- | Luminous Intensity I _v (mcd) @ 20 mA ^[1] | | Total Flux φ _v (lm) @ 20 mA ^[2] | Peak Wavelength λ _{peak} (nm) Typ. | Color, Dominant Wavelength λ _d ^[3] (nm) Typ. | Viewing Angle 2θ ^{1/2} Degrees ^[4] Typ. | Luminous Efficacy η _v ^[5] (lm/w) |
|----------------------|--|------|---|--|---|--|---|
| | Min. | Typ. | Typ. | | | | |
| Q106-R00xx | 100 | 400 | 280 | 654 | 644 | 15 | 85 |
| Q102-N00xx | 25 | 100 | - | 654 | 644 | 35 | 85 |
| P106-Q00xx | 63 | 130 | 280 | 654 | 644 | 75 | 85 |

Optical Characteristics at T_A = 25°C

| Part Number (Low Current) HLMP- | Luminous Intensity I _v (mcd) @ 0.5 mA ^[1] | | Total Flux φ _v (lm) @ 0.5 mA ^[2] | Peak Wavelength λ _{peak} (nm) Typ. | Color, Dominant Wavelength λ _d ^[3] (nm) Typ. | Viewing Angle 2φ ^{1/2} Degrees ^[4] Typ. | Luminous Efficacy η _v ^[5] (lm/w) |
|---------------------------------------|---|------|--|--|---|--|---|
| | Min. | Typ. | Typ. | | | | |
| Q156-H00xx | 2.5 | 7 | 10.5 | 654 | 644 | 15 | 85 |
| Q152-G00xx | 1.6 | 2 | - | 654 | 644 | 35 | 85 |
| P156-EG0xx | 0.63 | 2 | 10.5 | 654 | 644 | 75 | 85 |

Notes:

- The luminous intensity, I_v, is measured at the mechanical axis of the lamp package. The actual peak of the spatial radiation pattern may not be aligned with this axis.
- φ_v is the total luminous flux output as measured with an integrating sphere.
- The dominant wavelength, λ_d, is derived from the CIE Chromaticity Diagram and represents the color of the device.
- θ^{1/2} is the off-axis angle where the luminous intensity is 1/2 the peak intensity.
- Radiant intensity, I_r, in watts/steradian, may be calculated from the equation I_r = I_v/η_v, where I_v is the luminous intensity in candelas and η_v is the luminous efficacy in lumens/watt.

Electrical Characteristics at $T_A = 25^\circ\text{C}$

| Part Number HLMP- | Forward Voltage V_F (Volts) @ $I_F = 20\text{ mA}$ | | Reverse Breakdown V_R (Volts) @ $I_R = 100\ \mu\text{A}$ | | Capacitance C (pF) $V_F = 0$, $f = 1\text{ MHz}$ Typ. | Thermal Resistance $R\theta_{J-PIN}$ ($^\circ\text{C}/\text{W}$) | Speed of Response t_s (ns) Time Constant e^{-t/t_s} Typ. |
|----------------------|---|------|---|------|---|---|--|
| | Typ. | Max. | Min. | Typ. | | | |
| Q106 | 1.9 | 2.4 | 5 | 20 | 20 | 170 | 45 |
| Q102 | 1.9 | 2.4 | 5 | 20 | 20 | 170 | 45 |
| P106 | 1.9 | 2.4 | 5 | 20 | 20 | 170 | 45 |

Electrical Characteristics at $T_A = 25^\circ\text{C}$

| Part Number (Low Current) HLMP- | Forward Voltage V_F (Volts) @ $I_F = 0.5\text{ mA}$ | | Reverse Breakdown V_R (Volts) @ $I_R = 100\ \mu\text{A}$ | | Capacitance C (pF) $V_F = 0$, $f = 1\text{ MHz}$ Typ. | Thermal Resistance $R\theta_{J-PIN}$ ($^\circ\text{C}/\text{W}$) | Speed of Response t_s (ns) Time Constant e^{-t/t_s} Typ. |
|---------------------------------------|--|------|---|------|---|---|--|
| | Typ. | Max. | Min. | Typ. | | | |
| Q156 | 1.6 | 1.9 | 5 | 20 | 20 | 170 | 45 |
| Q152 | 1.6 | 1.9 | 5 | 20 | 20 | 170 | 45 |
| P156 | 1.6 | 1.9 | 5 | 20 | 20 | 170 | 45 |

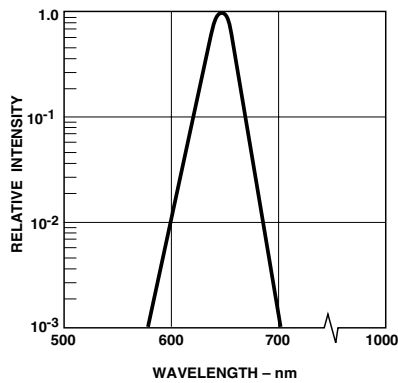

Figure 2. Relative intensity vs. wavelength.

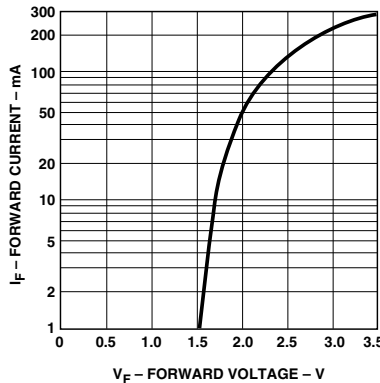

Figure 3. Forward current vs. forward voltage.

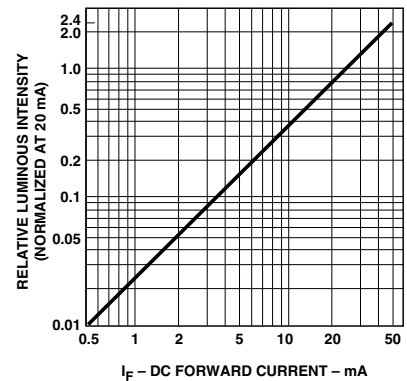

Figure 4. Relative luminous intensity vs. DC forward current.

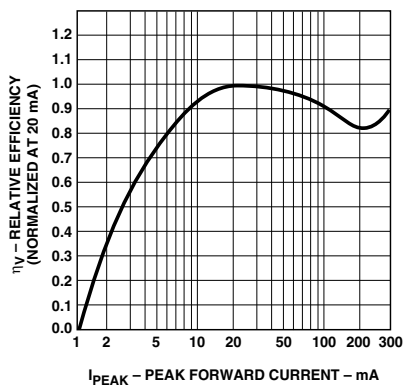

Figure 5. Relative efficiency vs. peak forward current.

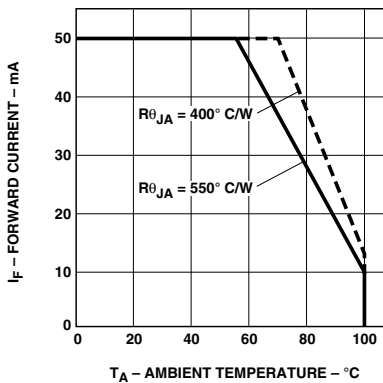

Figure 6. Maximum forward DC current vs. ambient temperature. Derating based on $T_{JMAX} = 110^\circ\text{C}$.

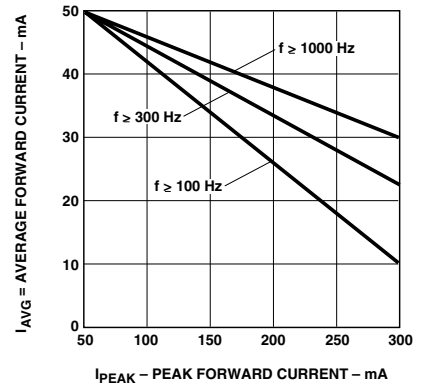

Figure 7. Maximum average current vs. peak forward current.

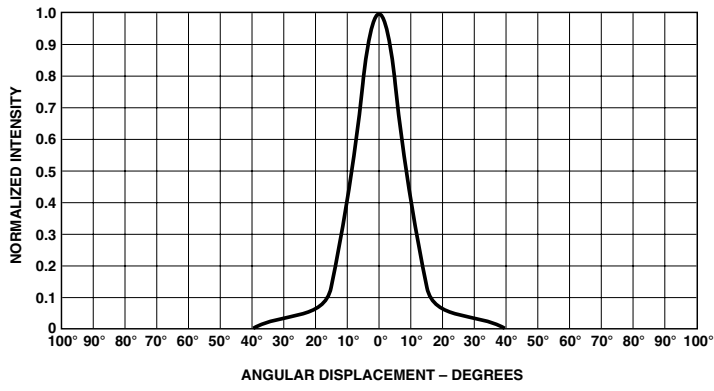

Figure 8. HLMP-Q106/-Q156.

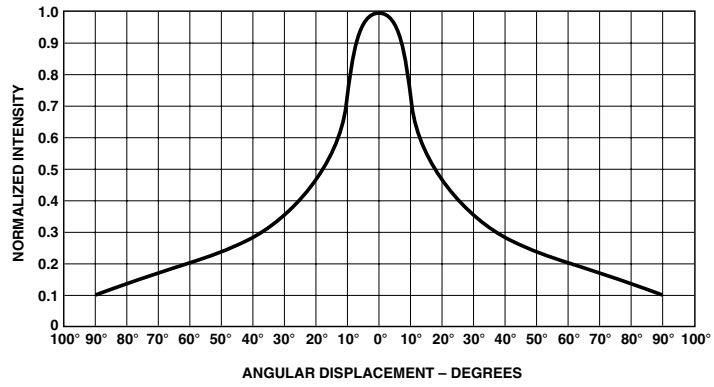

Figure 9. HLMP-Q102/-Q152

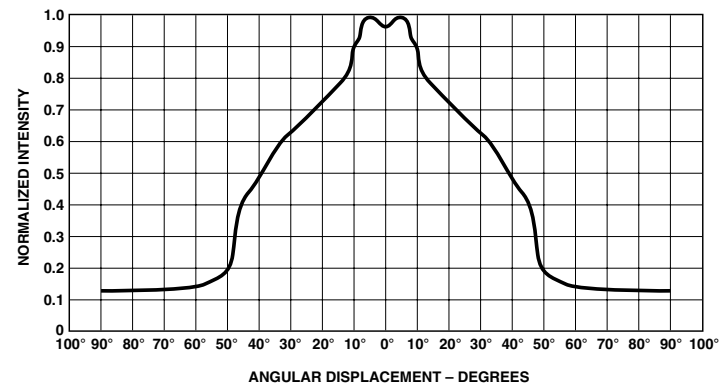

Figure 10. HLMP-P106/-P156.

Intensity Bin Limits

| Bin | Min. | Max. |
|------------|-------------|-------------|
| E | 0.63 | 1.25 |
| F | 1.00 | 2.00 |
| G | 1.60 | 3.20 |
| H | 2.50 | 5.00 |
| J | 4.00 | 8.00 |
| K | 6.30 | 12.50 |
| L | 10.00 | 20.00 |
| M | 16.00 | 32.00 |
| N | 25.00 | 50.00 |
| P | 40.00 | 80.00 |
| Q | 63.00 | 125.00 |
| R | 100.00 | 200.00 |
| S | 160.00 | 320.00 |
| T | 250.00 | 500.00 |
| U | 400.00 | 800.00 |
| V | 630.00 | 1250.00 |
| W | 1000.00 | 2000.00 |
| X | 1600.00 | 3200.00 |
| Y | 2500.00 | 5000.00 |

Color Bin Limits

| Package | Bin | Min. | Max. |
|----------------|------------|-------------------|-------------|
| Red | 0 | Full Distribution | |

Mechanical Option

| | |
|----|--|
| 00 | Straight Leads, Bulk Packaging, Quantity of 500 Parts |
| 11 | Gull Wing Leads, 12 mm Tape on 7 in. Dia. Reel, 1500 Parts per Reel |
| 12 | Gull Wing Lead, Bulk Packaging, Quantity of 500 Parts |
| 14 | Gull Wing Leads, 12 mm Tape on 13 in. Dia. Reel, 6000 Parts per Reel |
| 21 | Yoke Leads, 12 mm Tape on 7 in. Dia. Reel, 1500 Parts per Reel |
| 22 | Yoke Leads, Bulk Packaging, Quantity of 500 Parts |
| 24 | Yoke Leads, 12 mm Tape on 13 in. Dia. Reel, 6000 Parts per Reel |
| 31 | Z-Bend Leads, 12 mm Tape on 7 in. Dia. Reel, 1500 Parts per Reel |
| 32 | Z-Bend Leads, Bulk Packaging, Quantity of 500 Parts |
| 34 | Z-Bend Leads, 12 mm Tape on 13 in. Dia. Reel, 6000 Parts per Reel |

Note:

All Categories are established for classification of products. Products may not be available in all categories. Please contact your local Agilent representative for further clarification/information.

www.agilent.com/semiconductors

For product information and a complete list of distributors, please go to our web site.

For technical assistance call:

Americas/Canada: +1 (800) 235-0312 or (916) 788-6763

Europe: +49 (0) 6441 92460

China: 10800 650 0017

Hong Kong: (+65) 6756 2394

India, Australia, New Zealand: (+65) 6755 1939

Japan: (+81 3) 3335-8152(Domestic/International), or 0120-61-1280(Domestic Only)

Korea: (+65) 6755 1989

Singapore, Malaysia, Vietnam, Thailand, Philippines, Indonesia: (+65) 6755 2044

Taiwan: (+65) 6755 1843

Data subject to change.

Copyright © 2005 Agilent Technologies, Inc.

Obsoletes 5930-2437E

January 18, 2005

5989-1711EN



Agilent Technologies