

GaAs MMIC SMT HIGH-ISOLATION SPDT SWITCH DC - 8 GHz

FEBRUARY 2001

Features

BANDWIDTH: DC-8 GHz

HIGH ISOLATION : > 50 dB

NON-REFLECTIVE DESIGN

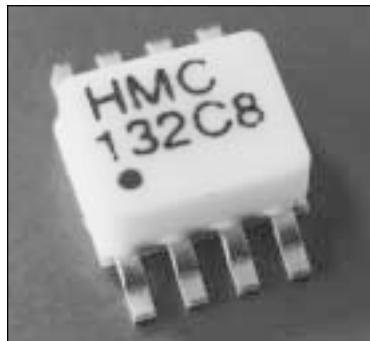

General Description

The HMC132C8 is a surface mount, low cost, non-hermetic packaged version of the HMC132G7 MMIC SPDT switch. The device is a fast, broadband SPDT switch featuring high (> 42 dB) isolation over the entire band. The switch is non-reflective at both RF1 and RF2 ports. Applications for this device include T/R switching for 5.2 GHz UNII, 5.8 GHz ISM circuits, WLAN, and S,C and X-Band Telecom radios.

7

SMT SPDT SWITCHES



Guaranteed Performance, With 0/-5V control, 50 Ohm System, -55 to +85 deg C

Parameter	Frequency	Min.	Typ.	Max.	Units
Insertion Loss	DC - 2 GHz		1.4	1.7	dB
	DC - 6 GHz		1.8	2.2	dB
	DC - 8 GHz		2.6	3.0	dB
Isolation	DC - 2 GHz	50	54		dB
	DC - 6 GHz	38	45		dB
	DC - 8 GHz	36	40		dB
Return Loss (on state)	DC - 2 GHz	14	19		dB
	DC - 6 GHz	10	14		dB
	DC - 8 GHz	8	13		dB
Input Power for 0.1 dB Compression	0.5 - 8 GHz	+20	+25		dBm
Input Power for 1dB Compression (0/-5V Ctl)	0.5 - 8 GHz	+22	+27		dBm
Input Third Order Intercept	0.5 - 8 GHz	+38	+42		dBm
Switching Characteristics	DC - 8 GHz				
		tRISE, tFALL (10/90% RF)		3	ns
		tON, tOFF (50% CTL to 10/90% RF)		6	ns

HMC132C8 SMT HIGH-ISOLATION SPDT SWITCH DC - 8 GHZ

FEBRUARY 2001

Insertion Loss

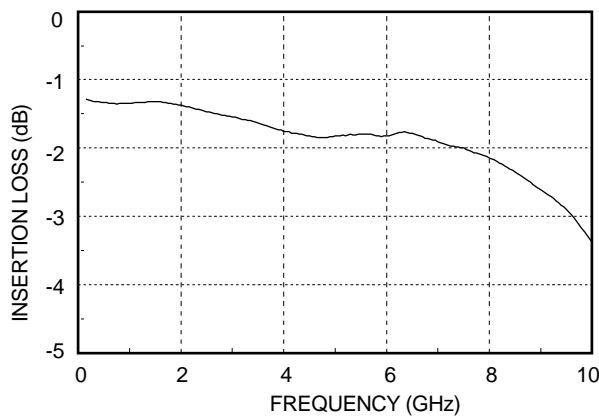

Isolation

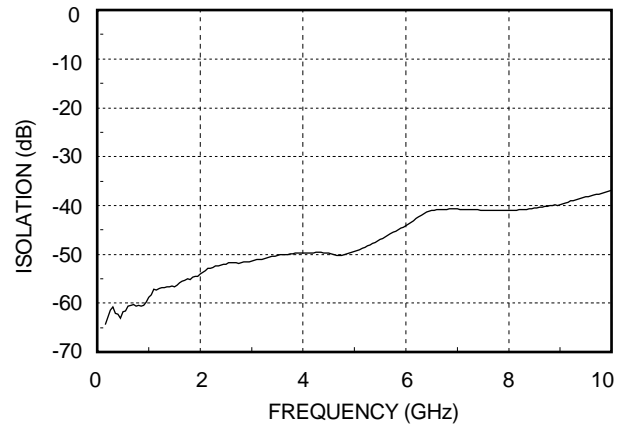

Return Loss

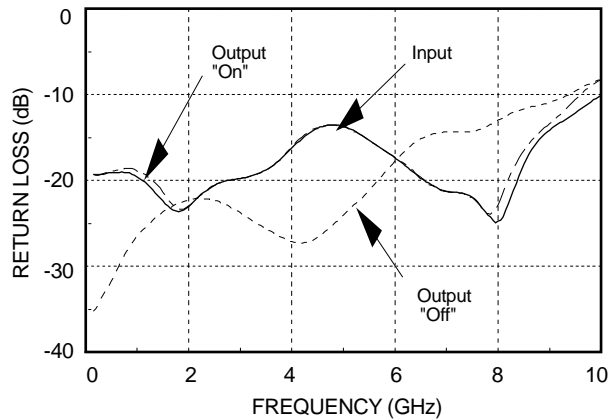

HMC132C8 SMT HIGH-ISOLATION SPDT SWITCH DC - 8 GHZ

FEBRUARY 2001

Schematic

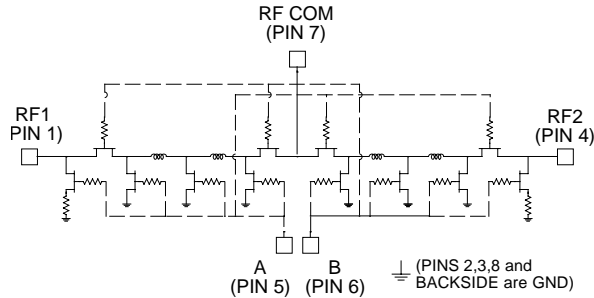

Absolute Maximum Ratings

Control Voltage Range	+0.5 to -7.5 Vdc
Storage Temperature	-65 to +175 deg C
Operating Temperature	-55 to +85 deg C

Truth Table

Control Input		Signal Path State	
A	B	RF to RF1	RF to RF2
High	Low	ON	OFF
Low	High	OFF	ON

Do not "HOT" switch power levels > +15 dBm ($V_{ctrl} = 0/-5Vdc$)

Control Voltages

State	Bias Condition
Low	0 to -0.2V @ 20uA Max.
High	-5V @ 200uA Typ to -7V @ 600uA Max

Outline

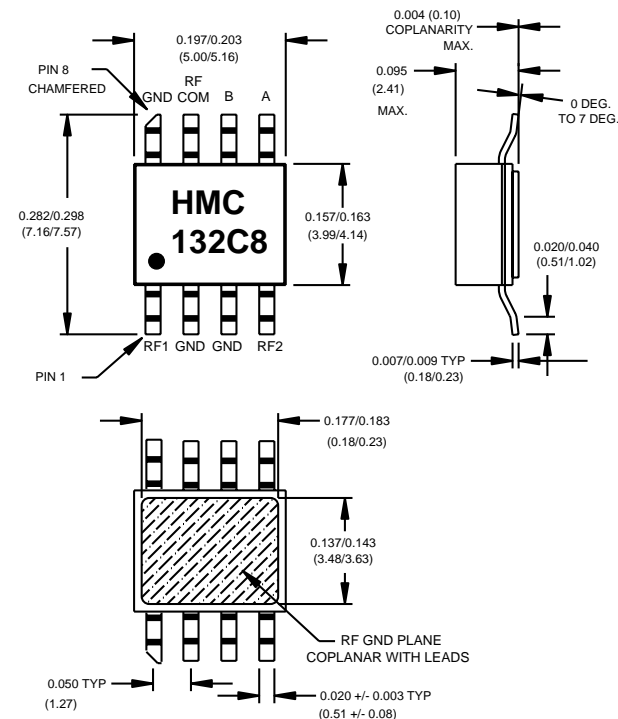

- MATERIAL:
 - PACKAGE BODY & COVER : WHITE ALUMINA (92%)
 - LEADS & PACKAGE BOTTOM: COPPER
- PLATING : ELECTROLYTIC GOLD 100 - 200 MICRONS OVER ELECTROLYTIC NICKEL 100 TO 200 MICRONS.
- DIMENSIONS ARE IN INCHES (MILLIMETERS). UNLESS OTHERWISE SPECIFIED TOL. ARE $\pm 0.005 (\pm 0.13)$.
- ALL UNLABELED LEADS ARE GROUND. THESE LEADS ARE CONNECTED INTERNALLY TO THE PACKAGED BOTTOM GROUND. THE PACKAGE BOTTOM RF GROUND **MUST** BE SOLDERED TO THE PCB RF GROUND.
- PACKAGE LENGTH AND WIDTH DIMENSIONS SHOWN DO NOT INCLUDE LID SEAL PROTRUSION. ALLOWABLE PROTRUSION SHALL BE 0.005 (0.127MM) PER SIDE.

7

SPDT SWITCHES

SMT



HMC132C8 SMT HIGH-ISOLATION SPDT SWITCH DC - 8 GHZ

FEBRUARY 2001

Suggested Driver Circuit for HMC132C8

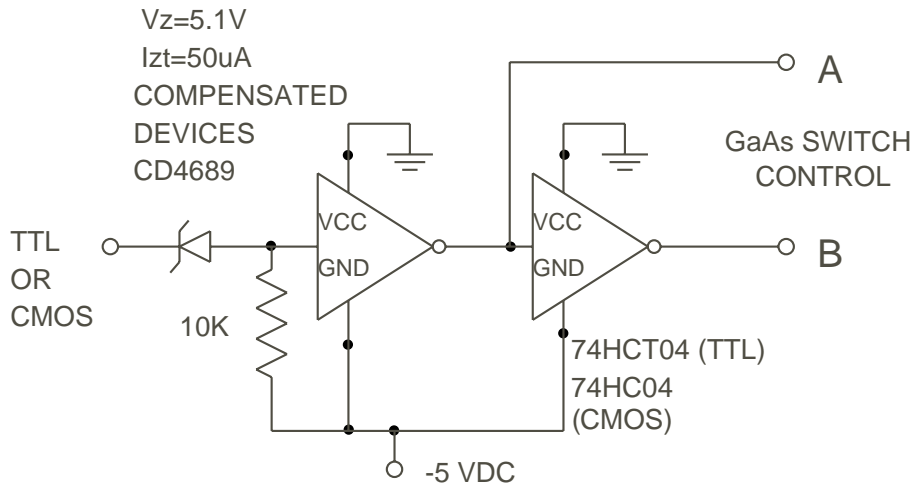

Simple driver using inexpensive standard logic ICs provides fast switching using minimum DC current.

HMC132C8 SMT HIGH-ISOLATION SPDT SWITCH DC - 8 GHZ

FEBRUARY 2001

Evaluation Circuit Board

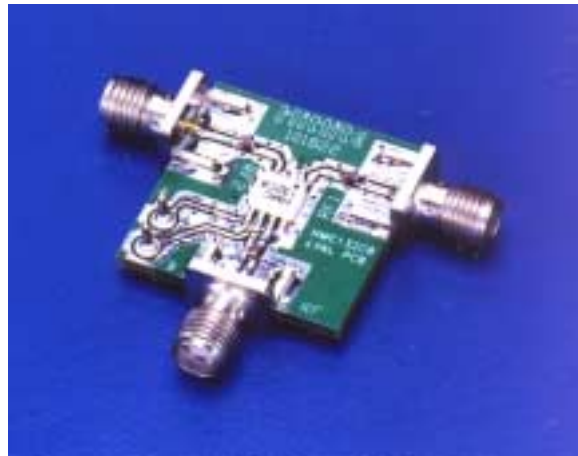

7
SMT SPDT SWITCHES

The circuit board used in the final application should use RF circuit design techniques. Signal lines should have 50 ohm impedance while the package ground leads should be connected directly to the ground plane similar to that shown above. A sufficient number of VIA holes should be used to connect the top and bottom ground planes. The evaluation circuit board as shown is available from Hittite upon request.

Evaluation Circuit Board Layout Design Details

Layout Technique	Grounded Co-Planar Waveguide (GCPW)
Material	Rogers 4350
Dielectric Thickness	0.020" (0.51 mm)
50 Ohm Line Width	0.034" (0.86 mm)
Gap to Ground Edge	0.010" (0.25 mm)
Ground VIA Hole Diameter	0.014" (0.36 mm)
Connectors	SMA-F (EF - Johnson P/N 142-0701-806)

HMC132C8 SMT HIGH-ISOLATION SPDT SWITCH DC - 8 GHZ

FEBRUARY 2001

NOTES: