

SMT DISTRIBUTED GaAs MMIC AMPLIFIER 20 - 32 GHz

FEBRUARY 2001

v01.0900

Features

SMT mmWAVE PACKAGE

13 dB GAIN

P1dB OUTPUT POWER: +12 dBm

SINGLE POSITIVE SUPPLY : +3V to +4V

NO GATE BIAS



General Description

The HMC261LM1 is a GaAs MMIC distributed amplifier in a SMT leadless chip carrier package covering 20 to 32 GHz. The LM1 is a true surface mount broadband millimeterwave package offering low loss & excellent I/O match, preserving MMIC chip performance. Utilizing a GaAs PHEMT process the device offers 13 dB gain and +14 dBm saturated output power from a bias supply of +4V @ 75 mA. The packaged amplifier enables economical PCB SMT assembly for millimeterwave point-to-point radios, LMDS, and SATCOM applications. As an alternative to chip-and-wire hybrid assemblies the HMC261LM1 eliminates the need for wirebonding, thereby providing a consistent connection interface for the customer. All data is with the non-hermetic, epoxy sealed LM1 packaged LNA device mounted in a 50 ohm test fixture. This part replaces the HMC261CB1 by offering more bandwidth and gain.

Guaranteed Performance, $V_{dd} = +4V$, -55 to $+85$ deg C

Parameter	Min.	Typ.	Max.	Min.	Typ.	Max.	Units
Frequency Range	20 - 32			27 - 30			GHz
Gain	8	13	17	10	13	16	dB
Input Return Loss	5	8		6	8		dB
Output Return Loss	10	12		10	12		dB
Reverse Isolation		35			40		dB
Output Power for 1dB Compression (P1dB0)	8	12		8	12		dBm
Saturated Output Power (Psat)	10	14		11	14		dBm
Output Third Order Intercept (IP3)	16	21		17	21		dBm
Noise Figure		8.5	12.5		7	8.5	dB
Supply Voltage (Vdd)	2.75	4.0	4.25	2.75	4.0	4.25	Vdc
Supply Current (Idd) (Vdd = 4.0 Vdc)		75	90		75	90	mA



SMT DISTRIBUTED GaAs MMIC AMPLIFIER 20 - 32 GHz

v01.0900

FEBRUARY 2001

Gain @ Vdd = +4V

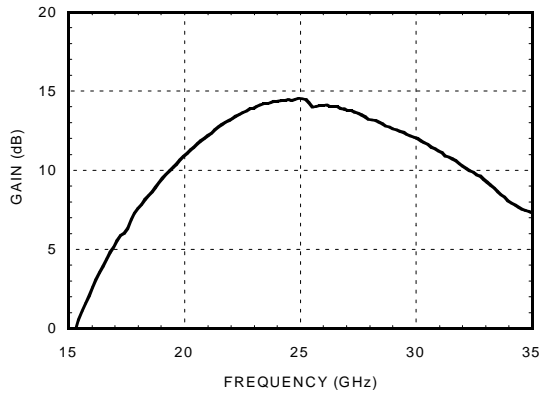

Gain @ Vdd = +3V

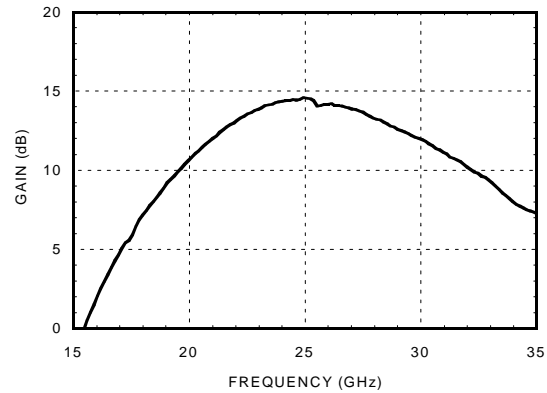

Return Loss @ Vdd = +4V

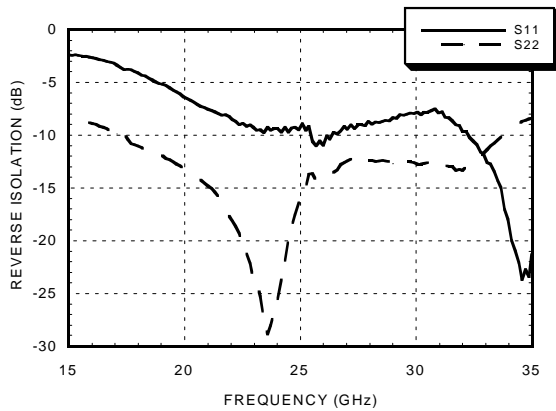

Return Loss @ Vdd = +3V

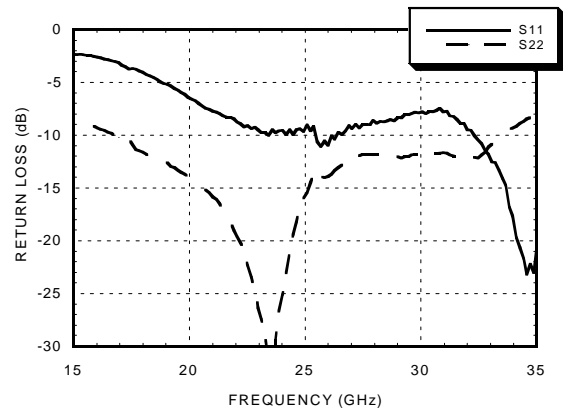

Reverse Isolation @ Vdd = +4V

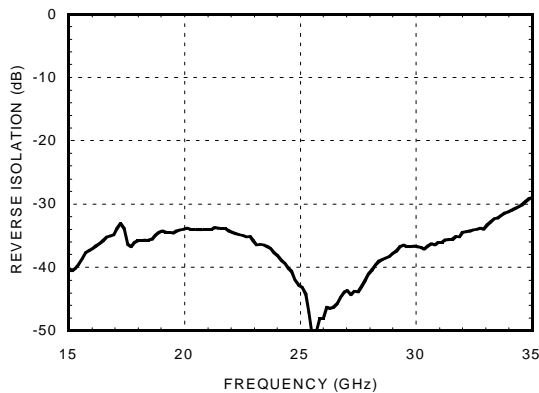

Reverse Isolation @ Vdd = +3V

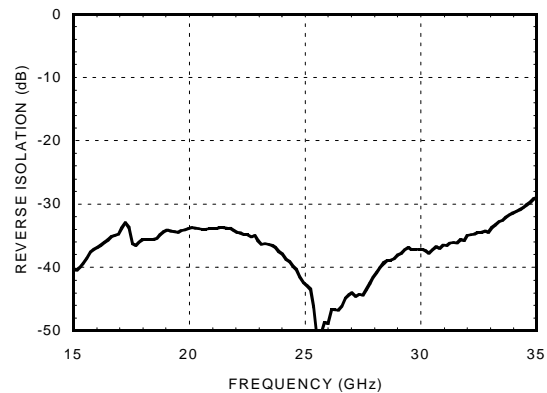

1
AMPLIFIERS
SMT

SMT DISTRIBUTED GaAs MMIC AMPLIFIER 20 - 32 GHz

FEBRUARY 2001

v01.0900

P1dB Output Power vs. Temperature @ Vdd= +3V

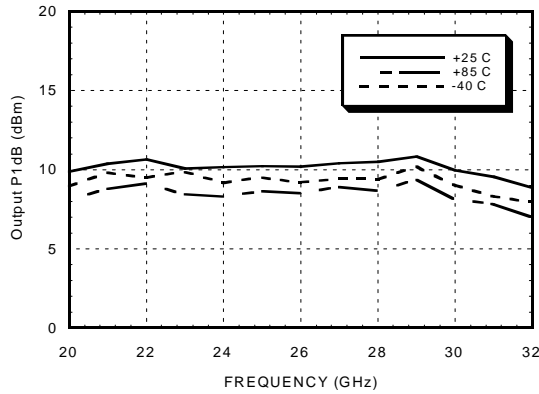

P1dB Output Power vs. Temperature @ Vdd= +4V

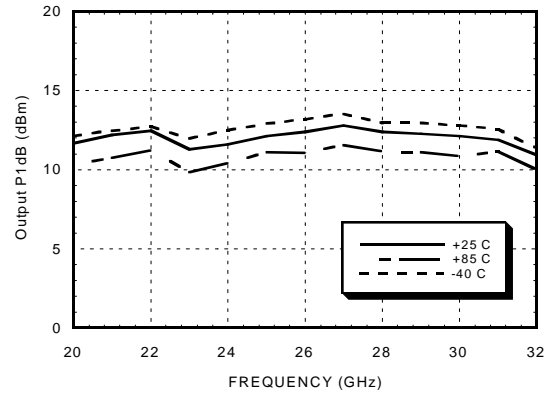

Psat vs. Temperature @ Vdd = +3V

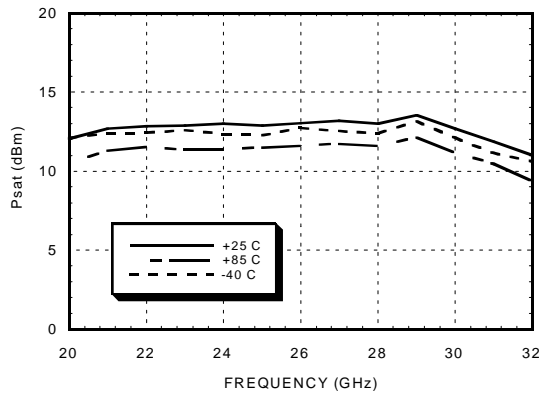

Psat vs. Temperature @ Vdd= +4V

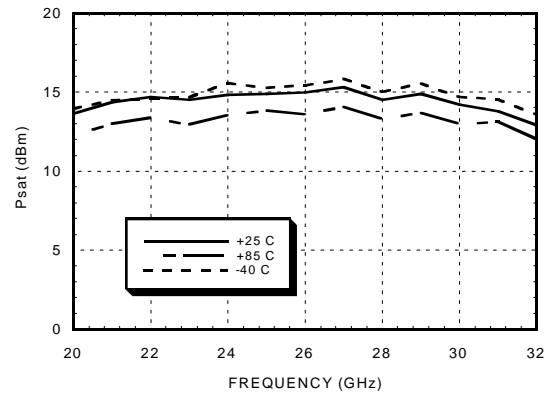

IP3 vs. Temperature @ Vdd = +3V

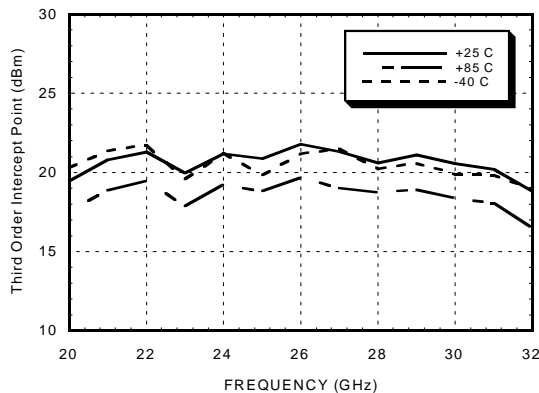

IP3 vs. Temperature @ Vdd = +4V

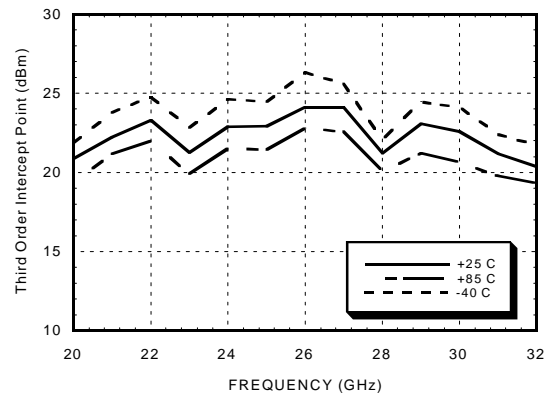

SMT DISTRIBUTED GaAs MMIC AMPLIFIER 20 - 32 GHz

v01.0900

FEBRUARY 2001

Functional Diagram

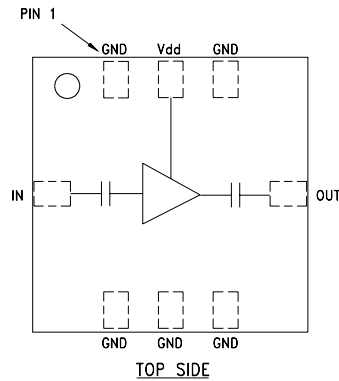

Absolute Maximum Ratings

Supply Voltage (Vdd)	+5.5 Vdc
Input Power (RF _{in}) (Vdd = +3V)	+16 dBm
Channel Temperature (T _c)	175 °C
Thermal Resistance (Θ _{jc})	90 °C / W
Storage Temperature	-65 to +150 °C
Operating Temperature	-55 to +85 °C

Outline Drawing

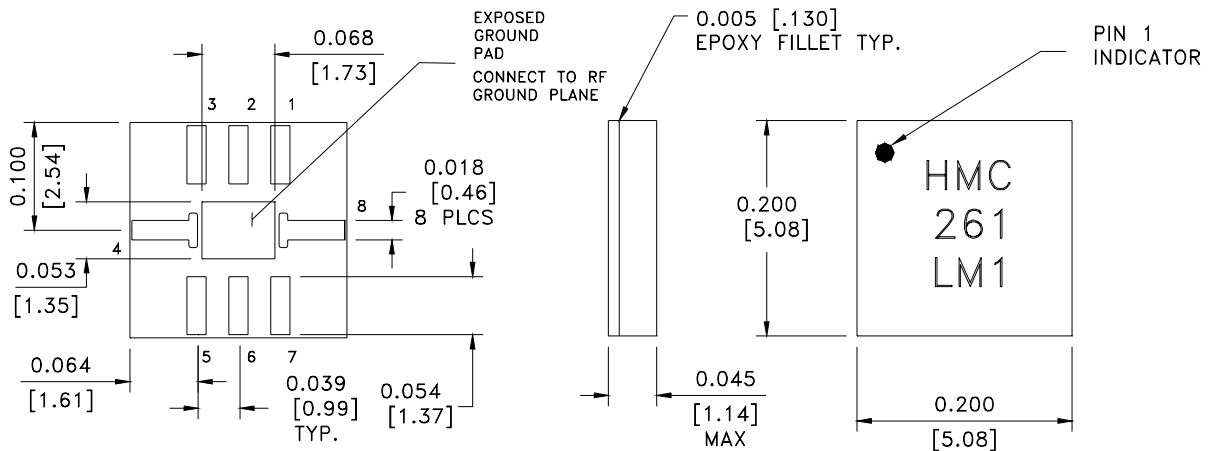

PIN	Function
1	GND
2	Vdd
3	GND
4	RF OUT
5	GND
6	GND
7	GND
8	RF IN

1. MATERIAL:
- A) PACKAGE BODY & LID: PLASTIC.
 - B) PIN CONTACT: COPPER, 0.5 OUNCE.
2. PLATING: ELECTROLYTIC GOLD (20 - 50 MICROINCHES TYPICAL) OVER ELECTROLYTIC NICKEL (50 MICROINCHES MINIMUM).
3. DIMENSIONS ARE IN INCHES (MILLIMETERS). UNLESS OTHERWISE SPECIFIED ALL TOLERANCES ARE ± 0.005 (± 0.13).
4. ALL GROUNDS MUST BE SOLDERED TO THE PCB RF GROUND.
5. SEE APPLICATION NOTE FOR RECOMMENDED ATTACHMENT TECHNIQUE TO PCB.

1
AMPLIFIERS
SMT

SMT DISTRIBUTED GaAs MMIC AMPLIFIER 20 - 32 GHz

FEBRUARY 2001

v01.0900

HMC261LM1 Evaluation PCB

1
SMT AMPLIFIERS

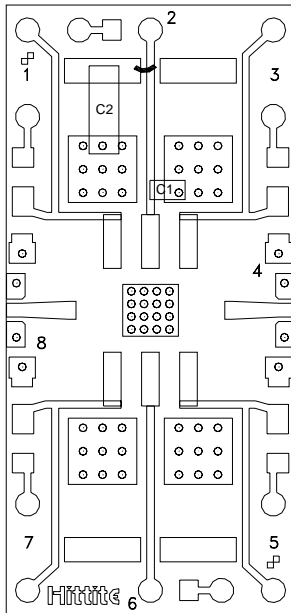

LM1 Evaluation PCB

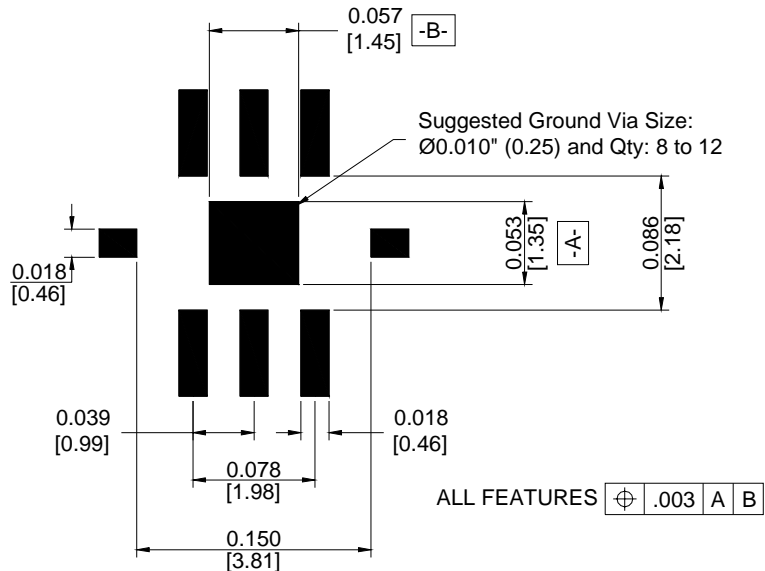

Suggested LM1 PCB Land Pattern
Tolerance: $\pm 0.003"$ (± 0.08 mm)

The grounded Co-Planar Wave Guide (G-CPW) PCB input/output transitions allow use of Ground-Signal-Ground (GSG) probes for testing. Suggested probe pitch is 400 μ m (16 mils). Alternatively, the board can be mounted in a metal housing with 2.4 mm coaxial connectors.

Evaluation Circuit Board Layout Design Details

Layout Technique	Micro Strip to G-CPW
Material	Rogers 4003 with 1/2 oz, Cu
Dielectric Thickness	0.008" (0.20 mm)
Microstrip Line Width	0.018" (0.46 mm)
G - CPW Line Width	0.016" (0.41 mm)
G - CPW Line to GND Gap	0.005" (0.13 mm)
Ground Via Hole Diameter	0.008" (0.13 mm)
C1	100 pF Capacitor, 0402 Pkg.
C2	10,000 pF Capacitor, 1206 Pkg.

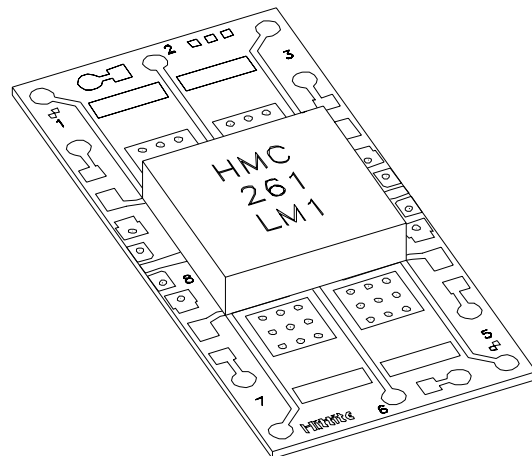

LM1 Package Mounted to Evaluation PCB

SMT DISTRIBUTED GaAs MMIC AMPLIFIER 20 - 32 GHz

v01.0900

FEBRUARY 2001

HMC261LM1 Application Circuit

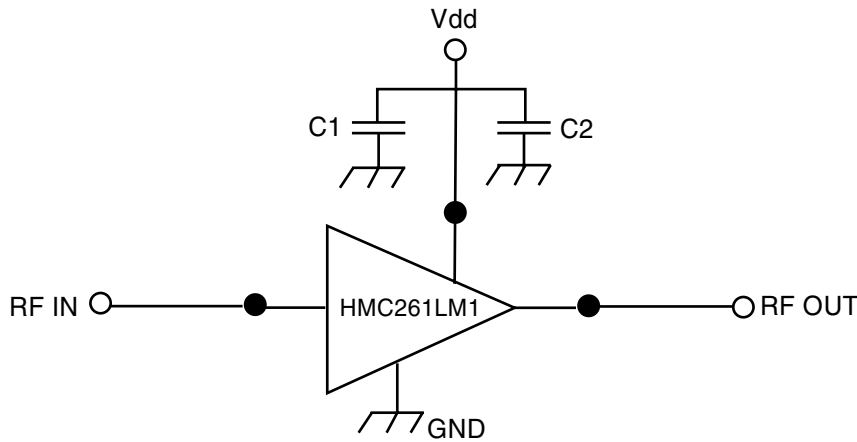

Recommended Component Values	
C1	100 pF
C2	10,000 pF

1

AMPLIFIERS

SMT



SMT DISTRIBUTED GaAs MMIC AMPLIFIER 20 - 32 GHz

FEBRUARY 2001

v01.0900

HMC261LM1 Recommended SMT Attachment Technique

Preparation & Handling of the LM1 Millimeterwave Package for Surface Mounting

The HMC LM1 package was designed to be compatible with high volume surface mount PCB assembly processes. The LM1 package requires a specific mounting pattern to allow proper mechanical attachment and to optimize electrical performance at millimeterwave frequencies. This PCB layout pattern can be found on each LM1 product data sheet. It can also be provided as an electronic drawing upon request from Hittite Sales & Application Engineering.

Follow these precautions to avoid permanent damage:

Cleanliness: Observe proper handling procedures to ensure clean devices and PCBs. LM1 devices should remain in their original packaging until component placement to ensure no contamination or damage to RF, DC & ground contact areas.

Static Sensitivity: Follow ESD precautions to protect against ESD strikes (see catalog page 8 - 2).

General Handling: Handle the LM1 package on the top with a vacuum collet or along the edges with a sharp pair of bent tweezers. Avoiding damaging the RF, DC, & ground contacts on the package bottom. Do not apply excess pressure to the top of the lid.

Solder Materials & Temperature Profile: Follow the information contained in the application note. Hand soldering is not recommended. Conductive epoxy attachment is not recommended.

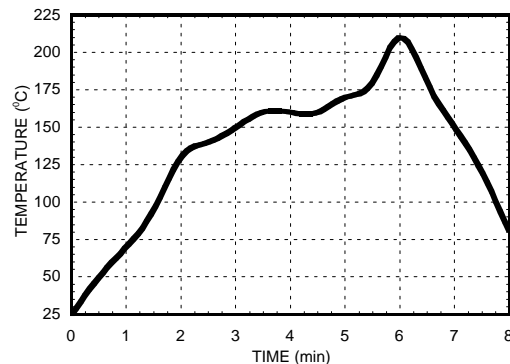

**Recommended solder reflow profile
for HMC LM1 SMT package**

Solder Paste

Solder paste should be selected based on the user's experience and be compatible with the metallization systems used. See the LM1 data sheet Outline drawing for pin & ground contact metallization schemes.

Solder Paste Application

Solder paste is generally applied to the PCB using either a stencil printer or dot placement. The volume of solder paste will be dependent on PCB and component layout and should be controlled to ensure consistent mechanical & electrical performance. Excess solder may create unwanted electrical parasitics at high frequencies.

Solder Reflow

The soldering process is usually accomplished in a reflow oven but may also use a vapor phase process. A solder reflow profile is suggested above.

Prior to reflowing product, temperature profiles should be measured using the same mass as the actual assemblies. The thermocouple should be moved to various positions on the board to account for edge and corner effects and varying component masses. The final profile should be determined by mounting the thermocouple to the PCB at the location of the device.

Follow solder paste and oven vendor's recommendations when developing a solder reflow profile. A standard profile will have a steady ramp up from room temperature to the pre-heat temperature to avoid damage due to thermal shock. Allow enough time between reaching pre-heat temperature and reflow for the solvent in the paste to evaporate and the flux to completely activate. Reflow must then occur prior to the flux being completely driven off. The duration of peak reflow temperature should not exceed 15 seconds. Packages have been qualified to withstand a peak temperature of 235°C for 15 seconds. Verify that the profile will not expose device to temperatures in excess of 235°C.

Cleaning

A water-based flux wash may be used.

SMT DISTRIBUTED GaAs MMIC AMPLIFIER 20 - 32 GHz

v01.0900

FEBRUARY 2001

NOTES:

1

AMPLIFIERS

SMT

