

GaAs MMIC HERMETIC SMT SPDT SWITCH, DC - 8.0 GHz

Typical Applications

The HMC347G8 is ideal for:

- Telecom Infrastructure
- Microwave Radio & VSAT
- Military Radios, Radar & ECM
- Test Instrumentation

Features

- Isolation: 42 dB @ 2.5 GHz
30 dB @ 6.0 GHz
- Insertion Loss: 2.0 dB @ 6.0 GHz
- Non-Reflective Design
- 8 Lead Hermetic SMT Package

Functional Diagram

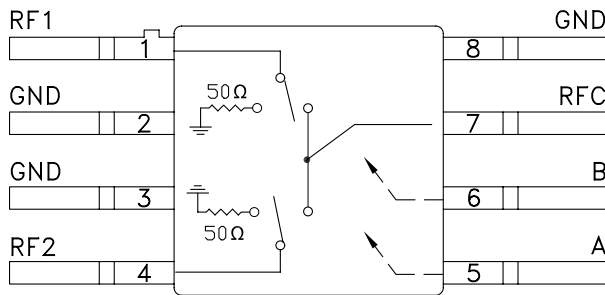

General Description

The HMC347G8 is a broadband high isolation non-reflective GaAs MESFET SPDT switch in a 8 lead glass/metal (hermetic) surface mount package. Covering DC to 8.0 GHz, the switch features >42 dB isolation up to 2 GHz and >25 dB isolation up to 8.0 GHz. The switch operates using complementary negative control voltage logic lines of -5/0V and requires no bias supply. This SPDT is a good replacement for the HMC132G7 SPDT.

Electrical Specifications, $T_A = +25^\circ C$, With 0/-5V Control, 50 Ohm System

| Parameter | Frequency | Min. | Typ. | Max. | Units |
|------------------------------------------------------------------------------------------------|---------------|--------------|------|------|-------|
| Insertion Loss | DC - 2.0 GHz | | 2.0 | 2.3 | dB |
| | DC - 6.0 GHz | | 2.2 | 2.6 | dB |
| | DC - 8.0 GHz | | 2.2 | 2.7 | dB |
| Isolation | DC - 2.0 GHz | 41 | 45 | | dB |
| | DC - 6.0 GHz | 27 | 30 | | dB |
| | DC - 8.0 GHz | 25 | 28 | | dB |
| Return Loss | "On State" | DC - 2.0 GHz | 9 | 12 | dB |
| | | DC - 8.0 GHz | 6 | 10 | dB |
| Return Loss RF1, RF2 | "Off State" | DC - 2.0 GHz | | 9 | dB |
| | | DC - 8.0 GHz | | 6 | dB |
| Input Power for 1 dB Compression | 0.5 - 8.0 GHz | 19 | 23 | | dBm |
| Input Third Order Intercept (Two-Tone Input Power= +7 dBm Each Tone, 1 MHz Tone Separation) | 0.5 - 8.0 GHz | 38 | 43 | | dBm |
| Switching Characteristics tRISE, tFALL (10/90% RF) tON, tOFF (50% CTL to 10/90% RF) | DC - 8.0 GHz | | 3 | | ns |
| | | | 6 | | ns |

GaAs MMIC HERMETIC SMT SPDT SWITCH, DC - 8.0 GHz

Insertion Loss

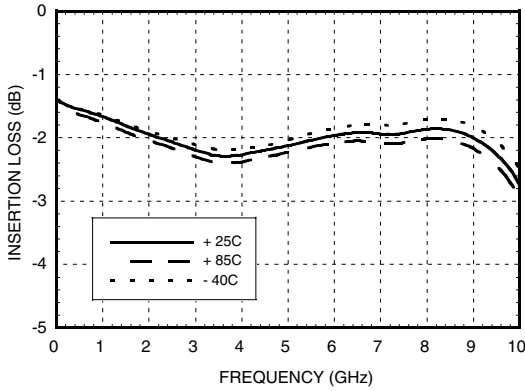

Isolation

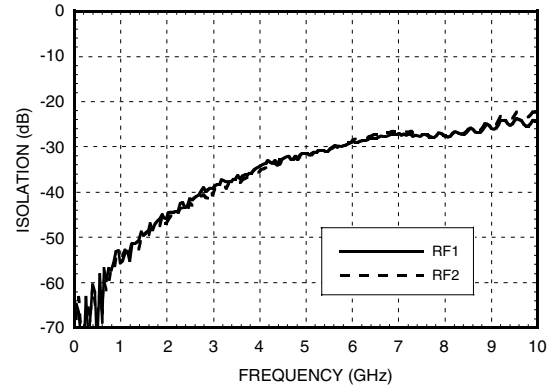

Return Loss

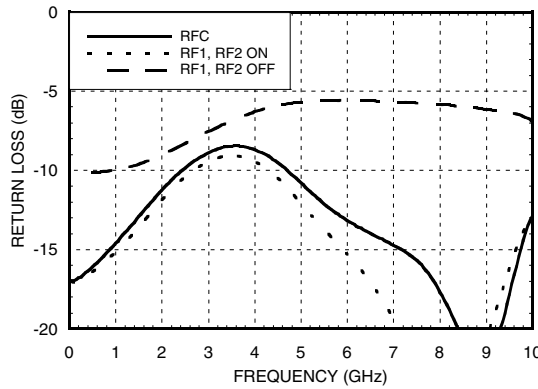

0.1 and 1 dB Input Compression Point

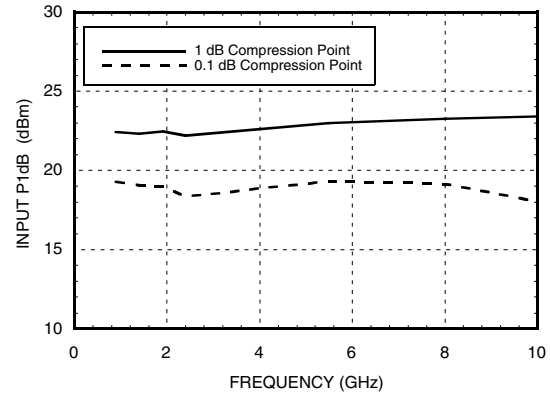

Input Third Order Intercept Point

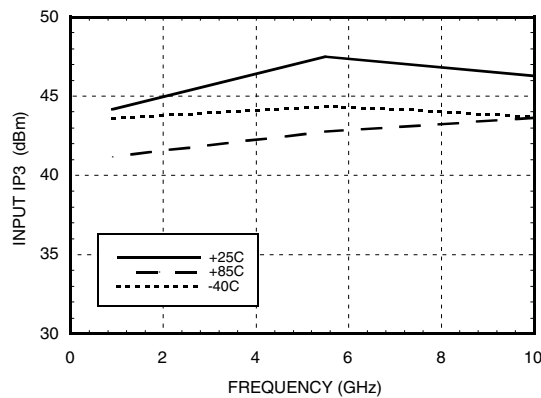

GaAs MMIC HERMETIC SMT SPDT SWITCH, DC - 8.0 GHz

Control Voltages

| State | Bias Condition |
|-------|-------------------------------------------------------|
| Low | 0 to -0.2V @ 10 uA Max. |
| High | -5V @ 10 uA Typ. to -7V @ 40 uA Typ. (± 0.5 Vdc) |

Truth Table

| Control Input | | Signal Path State | |
|---------------|------|-------------------|------------|
| A | B | RFC to RF1 | RFC to RF2 |
| High | Low | On | Off |
| Low | High | Off | On |

Caution: Do not "Hot Switch" power levels greater than +13 dBm ($V_{ctl} = 0/-5$ Vdc).

Absolute Maximum Ratings

| | |
|------------------------------------------|-------------------|
| RF Input Power ($V_{ctl} = -5V$) | +27 dBm |
| Control Voltage Range (A & B) | +0.5V to -7.5 Vdc |
| Channel Temperature | 150 °C |
| Thermal Resistance (Insertion Loss Path) | 440 °C/W |
| Thermal Resistance (Terminated Path) | 540 °C/W |
| Storage Temperature | -65 to +150 °C |
| Operating Temperature | -55 to +85 °C |

Outline Drawing

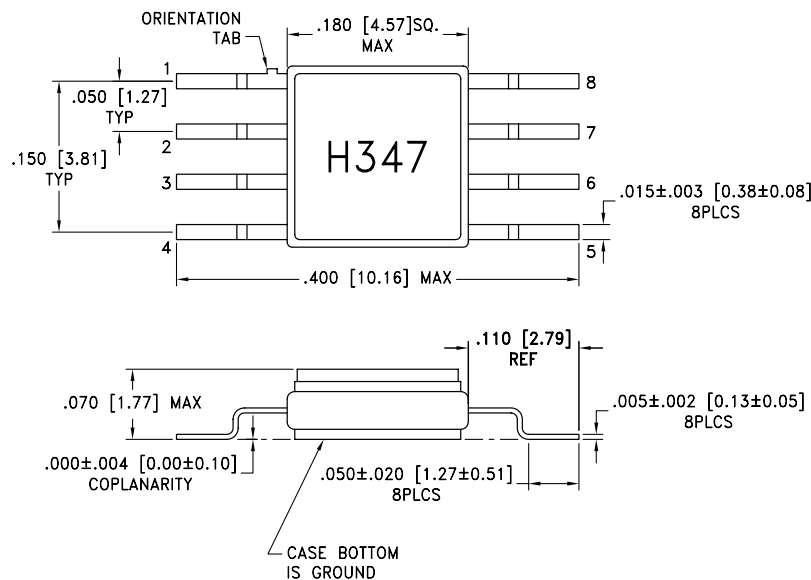

NOTES:

- PACKAGE MATERIAL: ALUMINA LOADED BOROSILICATE GLASS.
- LEAD, BASE, COVER MATERIAL: KOVAR™ (#7052 CORNING).
- PLATING: ELECTROLYTIC GOLD 50 MICROINCHES MIN., OVER ELECTROLYTIC NICKEL 50 MICROINCHES MIN.
- DIMENSIONS ARE IN INCHES [MILLIMETERS].
- TOLERANCES: $\pm .005$ [0.13] UNLESS OTHERWISE SPECIFIED.
- ALL GROUND LEADS AND GROUND PADDLE MUST BE SOLDERED TO PCB RF GROUND.

For price, delivery, and to place orders, please contact Hittite Microwave Corporation:
 12 Elizabeth Drive, Chelmsford, MA 01824 Phone: 978-250-3343 Fax: 978-250-3373
 Order Online at www.hittite.com

GaAs MMIC HERMETIC SMT SPDT SWITCH, DC - 8.0 GHz

Suggested Driver Circuit

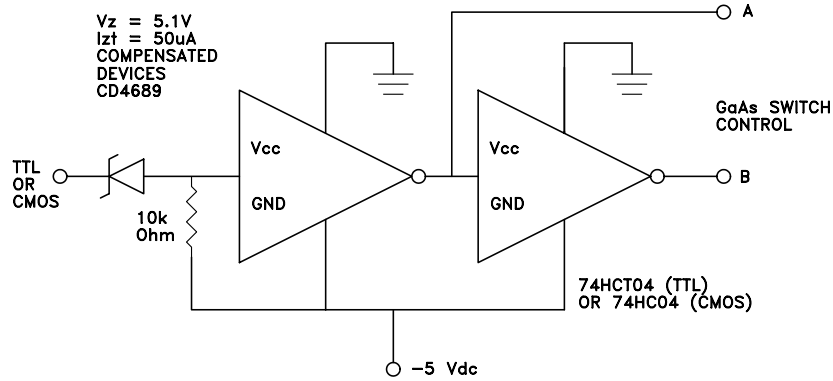

Pin Descriptions

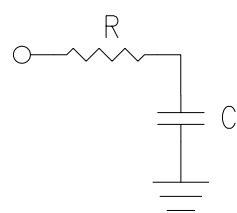
| Pin Number | Function | Description | Interface Schematic |
|------------|---------------|-------------------------------------------------------------------------------------------------------------------------|---------------------------------------------------------------------------------------|
| 1, 4, 7 | RFC, RF1, RF2 | This pin is DC coupled and matched to 50 Ohm. Blocking capacitors are required if RF line potential is not equal to 0V. | |
| 2, 3, 8 | GND | Package bottom must also be connected to PCB RF ground. |  |
| 5 | CTLA | See truth table and control voltage table. |  |
| 6 | CTLB | See truth table and control voltage table. | |

GaAs MMIC HERMETIC SMT SPDT SWITCH, DC - 8.0 GHz

Evaluation PCB

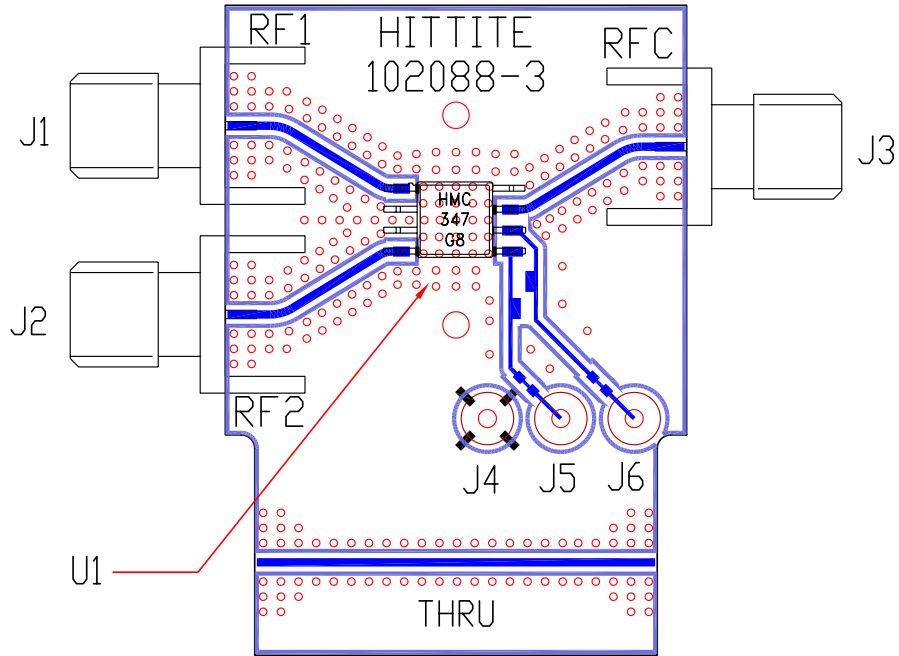

List of Material

| Item | Description |
|---------------------------------------|---------------------------|
| J1 - J3 | PC Mount SMA RF Connector |
| J4 - J6 | DC Pin |
| U1 | HMC347G8 SPDT Switch |
| PCB* | 102088-3 Evaluation PCB |
| * Circuit Board Material: Rogers 4350 | |

The circuit board used in the final application should be generated with proper RF circuit design techniques. Signal lines at the RF port should have 50 ohm impedance and the package ground leads and package bottom should be connected directly to the ground plane similar to that shown above. The evaluation circuit board shown above is available from Hittite Microwave Corporation upon request.

GaAs MMIC HERMETIC SMT SPDT SWITCH, DC - 8.0 GHz

Notes: