



### Typical Applications

The HMC591LP5 / HMC591LP5E is ideal for use as a power amplifier for:

- Point-to-Point Radios
- Point-to-Multi-Point Radios
- Test Equipment & Sensors
- Military End-Use
- Space

### Features

- Saturated Output Power: +33 dBm @ 20% PAE
- Output IP3: +41 dBm
- Gain: 18 dB
- DC Supply: +7.0 V @ 1340 mA
- 50 Ohm Matched Input/Output
- QFN Leadless SMT Packages, 25 mm<sup>2</sup>

### Functional Diagram

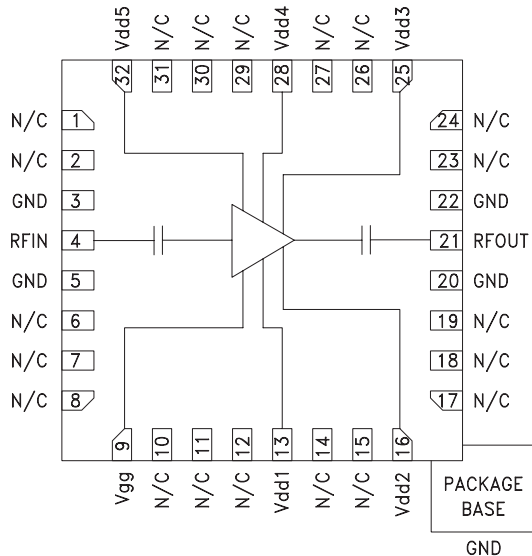

### General Description

The HMC591LP5 & HMC591LP5E are high dynamic range GaAs PHEMT MMIC 2 Watt Power Amplifiers which operate from 6 to 9.5 GHz. The amplifier provides 18 dB of gain, +33 dBm of saturated power, and 19% PAE from a +7.0V supply. This 50 Ohm matched amplifier does not require any external components and the RF I/Os are DC blocked for robust operation. For applications which require optimum OIP3, I<sub>dd</sub> should be set for 940 mA, to yield +41 dBm OIP3. For applications which require optimum output P1dB, I<sub>dd</sub> should be set for 1340 mA, to yield +33 dBm Output P1dB.

### Electrical Specifications, T<sub>A</sub> = +25° C, V<sub>dd</sub> = +7V, I<sub>dd</sub> = 1340 mA<sup>[1]</sup>

Parameter	Min.	Typ.	Max.	Min.	Typ.	Max.	Units
Frequency Range	6 - 8			6 - 9.5			GHz
Gain	16	19		15	18		dB
Gain Variation Over Temperature		0.05			0.05		dB/ °C
Input Return Loss		14			12		dB
Output Return Loss		12			10		dB
Output Power for 1 dB Compression (P1dB)	30	32		30	33		dBm
Saturated Output Power (Psat)		32.5			33		dBm
Output Third Order Intercept (IP3) <sup>[2]</sup>		41			41		dBm
Supply Current (I <sub>dd</sub> )		1340			1340		mA

[1] Adjust V<sub>gg</sub> between -2 to 0V to achieve I<sub>dd</sub>= 1340 mA typical.

[2] Measurement taken at 7V @ 940mA, Pin/Tone = -15 dBm



**Broadband Gain & Return Loss**

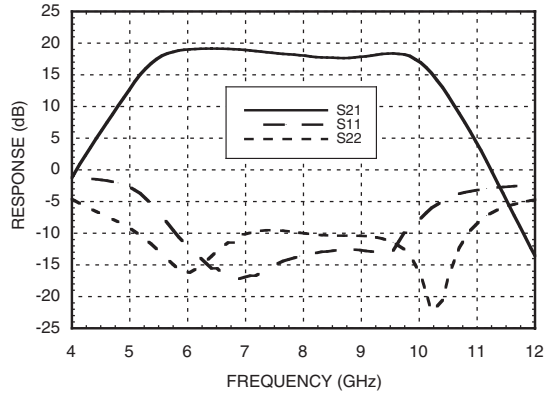

**Gain vs. Temperature**

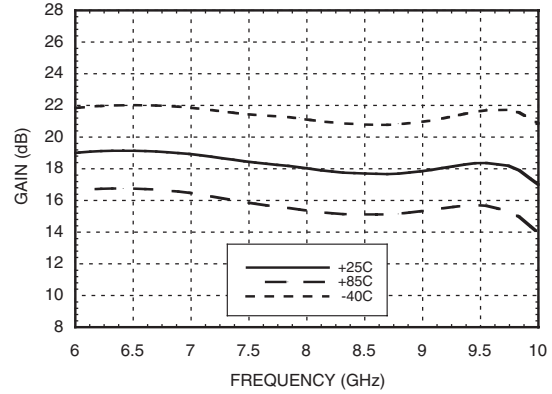

**Input Return Loss vs. Temperature**

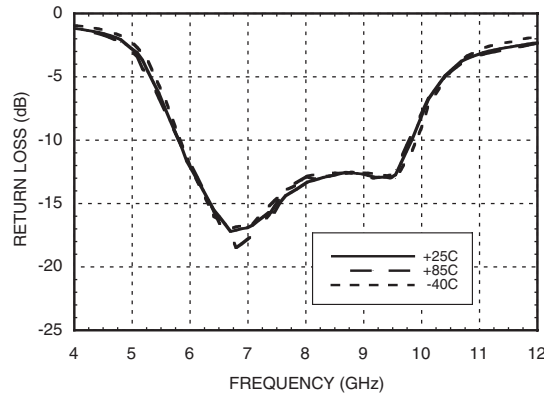

**Output Return Loss vs. Temperature**

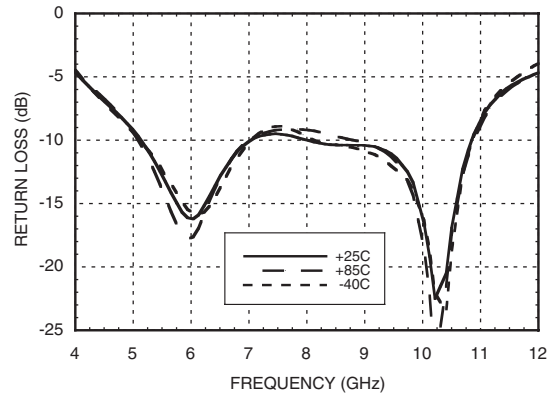

**P1dB vs. Temperature**

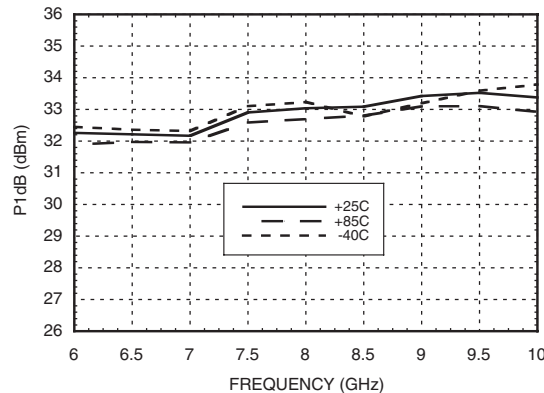

**Psat vs. Temperature**

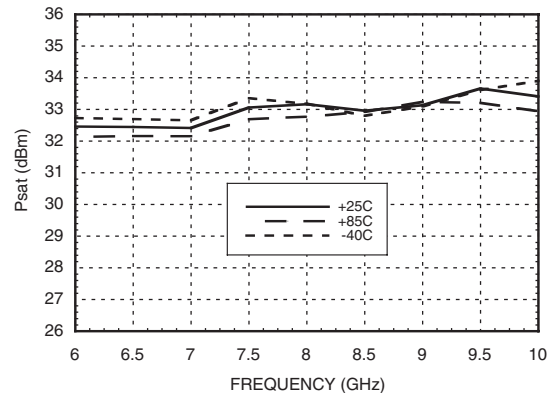

**P1dB vs. Current**

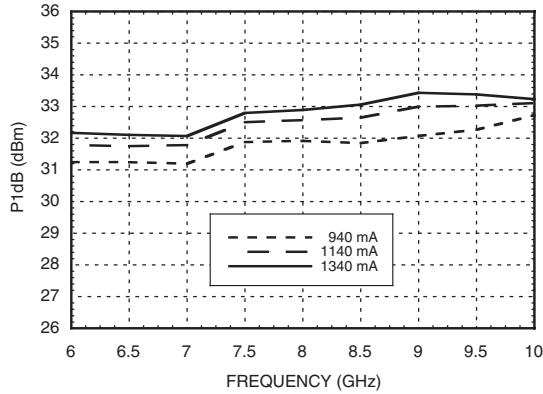

**Psat vs. Current**

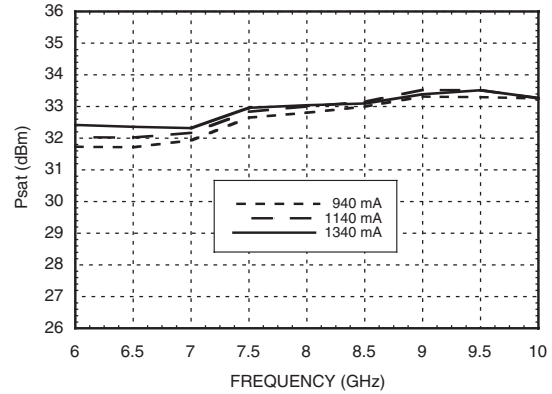

**Output IP3 vs. Temperature**  
7V @ 940 mA, Pin/Tone = -15 dBm

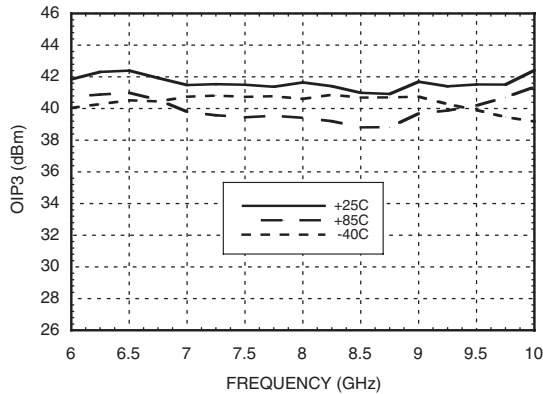

**Power Compression @ 8 GHz,**  
7V @ 1340 mA

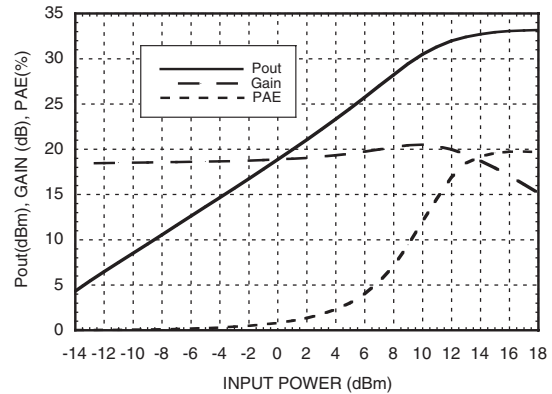

**Output IM3, 7V @ 940 mA**

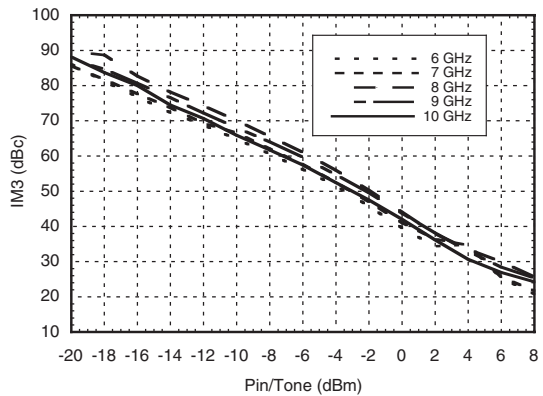

**Output IM3, 7V @ 1340 mA**

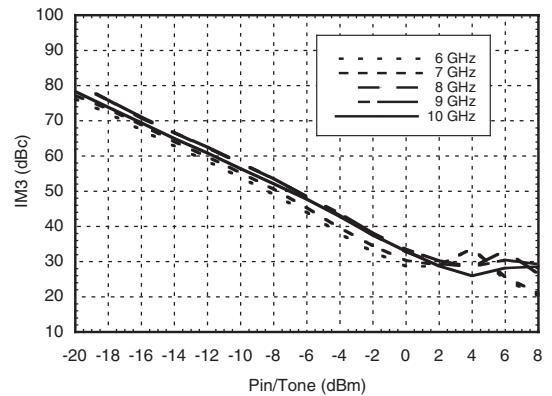

### Gain & Power vs. Supply Current @ 8 GHz

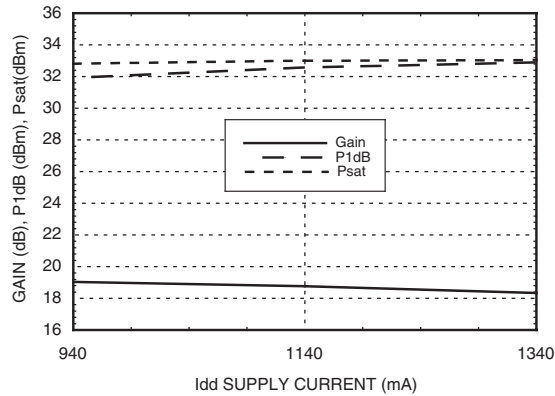

### Gain & Power vs. Supply Voltage @ 8 GHz

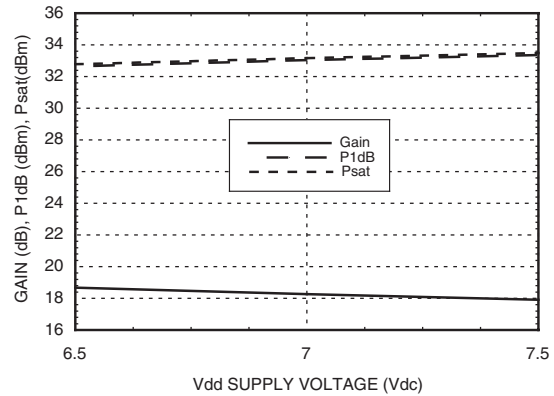

### Reverse Isolation vs. Temperature, 7V @ 1340 mA

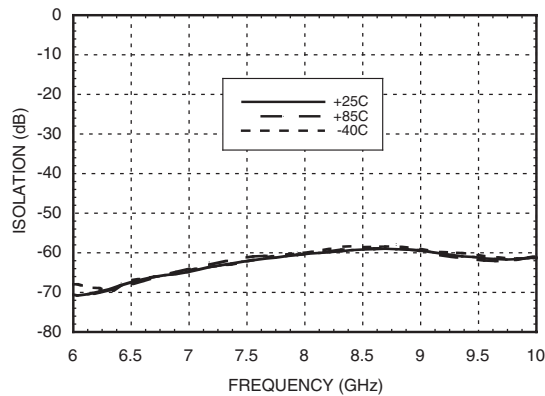

### Power Dissipation

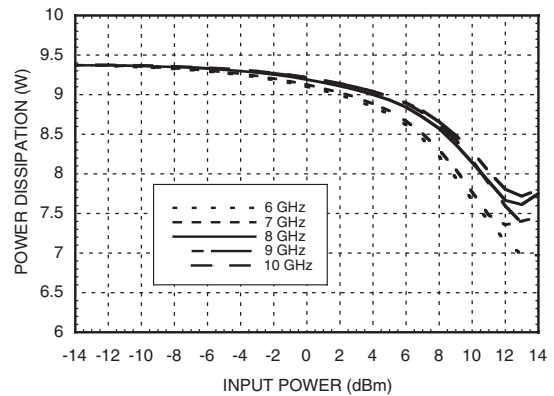

### Absolute Maximum Ratings

Drain Bias Voltage (V <sub>dd</sub> )	+8 Vdc
Gate Bias Voltage (V <sub>gg</sub> )	-2.0 to 0 Vdc
RF Input Power (RFin)(V <sub>dd</sub> = +7.0 Vdc)	+15 dBm
Channel Temperature	175 °C
Continuous Pdiss (T = 75 °C) (derate 104.3 mW/°C above 75 °C)	10.43 W
Thermal Resistance (channel to package bottom)	9.59 °C/W
Storage Temperature	-65 to +150 °C
Operating Temperature	-40 to +85 °C

### Typical Supply Current vs. V<sub>dd</sub>

V <sub>dd</sub> (V)	I <sub>dd</sub> (mA)
+6.5	1350
+7.0	1340
+7.5	1330

Note: Amplifier will operate over full voltage ranges shown above V<sub>gg</sub> adjusted to achieve I<sub>dd</sub> = 1340 mA at +7.0V



ELECTROSTATIC SENSITIVE DEVICE  
OBSERVE HANDLING PRECAUTIONS

### Outline Drawing

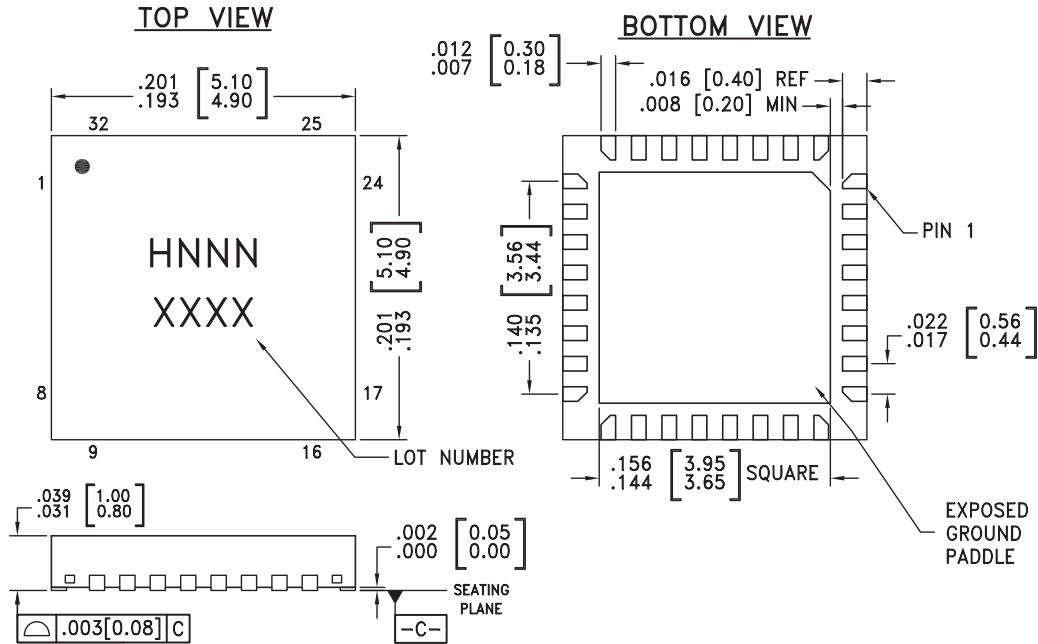

NOTES:

1. LEADFRAME MATERIAL: COPPER ALLOY
2. DIMENSIONS ARE IN INCHES [MILLIMETERS]
3. LEAD SPACING TOLERANCE IS NON-CUMULATIVE
4. PAD BURR LENGTH SHALL BE 0.15mm MAXIMUM.  
PAD BURR HEIGHT SHALL BE 0.05mm MAXIMUM.
5. PACKAGE WARP SHALL NOT EXCEED 0.05mm.
6. ALL GROUND LEADS AND GROUND PADDLE MUST BE SOLDERED TO PCB RF GROUND.
7. REFER TO HITTITE APPLICATION NOTE FOR SUGGESTED LAND PATTERN.

### Package Information

Part Number	Package Body Material	Lead Finish	MSL Rating	Package Marking <sup>[3]</sup>
HMC591LP5	Low Stress Injection Molded Plastic	Sn/Pb Solder	MSL1 <sup>[1]</sup>	H591 XXXX
HMC591LP5E	RoHS-compliant Low Stress Injection Molded Plastic	100% matte Sn	MSL1 <sup>[2]</sup>	H591 XXXX

[1] Max peak reflow temperature of 235 °C

[2] Max peak reflow temperature of 260 °C

[3] 4-Digit lot number XXXX

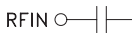
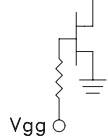
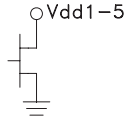
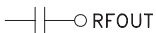

### Pad Descriptions

Pad Number	Function	Description	Interface Schematic
1, 2, 6 - 8, 10 - 12, 14, 15, 17 - 19, 23, 24, 26, 27, 29 - 31	N/C	Not connected.	
3, 5, 20, 22	GND	Package bottom has an exposed metal paddle that must be connected to RF/DC ground.	
4	RFIN	This pad is AC coupled and matched to 50 Ohms.	
9	Vgg	Gate control for amplifier. Adjust to achieve I <sub>dd</sub> of 1340 mA. Please follow "MMIC Amplifier Biasing Procedure" Application Note. External bypass capacitors of 100 pF and 2.2 μF are required.	
13, 16, 25, 28, 32	Vdd 1-5	Power Supply Voltage for the amplifier. External bypass capacitors of 100 pF and 2.2 μF are required.	
21	RFOUT	This pad is AC coupled and matched to 50 Ohms.	

### Application Circuit

Component	Value
C1 - C6	100pF
C7 - C12	2.2μF

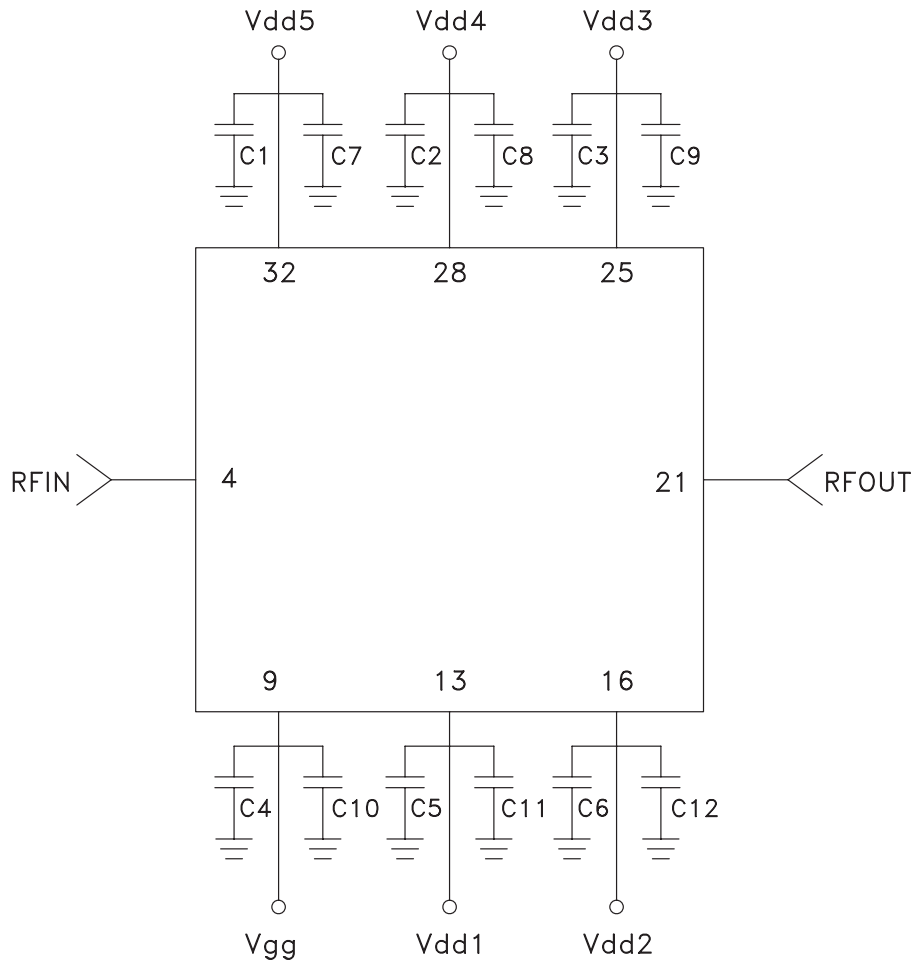

### Evaluation PCB

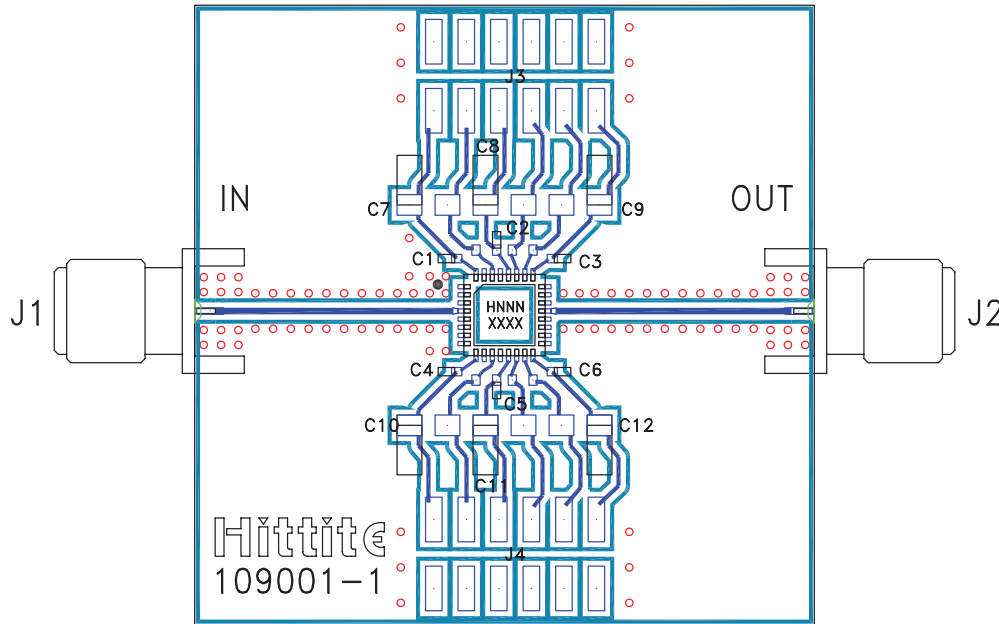

### List of Materials for Evaluation PCB 108190 [1]

Item	Description
J1 - J2	PCB Mount SMA Connector
J3 - J4	DC Pin
C1 - C6	100pF Capacitor, 0402 Pkg.
C7 - C12	2.2 $\mu$ F Capacitor, 1206 Pkg
U1	HMC591LP5 / HMC591LP5E
PCB [2]	109001 Evaluation PCB

[1] Reference this number when ordering complete evaluation PCB

[2] Circuit Board Material: Rogers 4350

The circuit board used in the final application should use RF circuit design techniques. Signal lines should have 50 ohm impedance while the package ground leads and package bottom should be connected directly to the ground plane similar to that shown. A sufficient number of via holes should be used to connect the top and bottom ground planes. The evaluation board should be mounted to an appropriate heat sink. The evaluation circuit board shown is available from Hittite upon request.