

HP - 3ML · HP - 3MLR2

The HP - 3ML is a high - output, high - speed photodiode mounted in a TO - 18 type header with clear epoxy encapsulation, The HP - 3MLR2 photodiode, with daylight filter, is available in the same package.

FEATURES

- High - output power
- High - speed response
- Wide angular response
- Relatively low - cost against metal can package

APPLICATIONS

- Optical detectors
- Optical switches

DIMENSIONS

(Unit : mm)

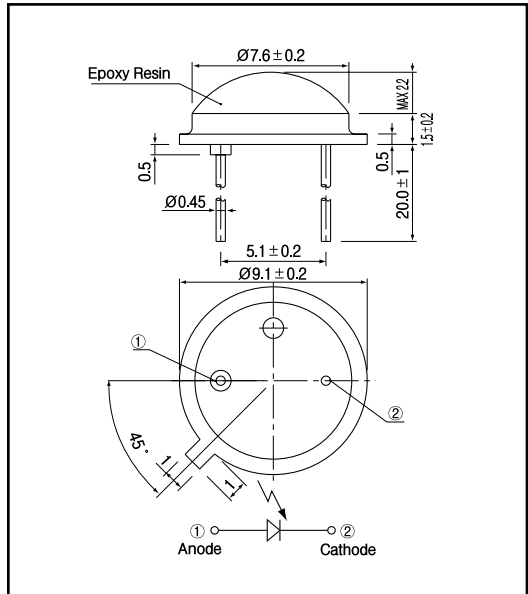

MAXIMUM RATINGS

(Ta=25)

Item	Symbol	Rating	Unit
Reverse voltage	V _r	5	V
Operating temp.	Topr.	- 20 ~ + 80	
Storage temp.	Tstg.	- 30 ~ + 100	
Soldering temp. **	Tsol.	260	

*1. For MAX.5 seconds at the position of 2 mm from the package

ELECTRO-OPTICAL CHARACTERISTICS

(Ta=25)

Item	Symbol	Conditions	HP - 3ML			HP - 3MLR2			Unit.
			Min.	Typ.	Max.	Min.	Typ.	Max.	
Open circuit voltage	V _{oc}	E _v = 1,000lx ⁻²		0.38			0.30		V
Short circuit current	I _{sc}		54	75			60		μA
Dark current	I _d	V _r = 5V			1			10	μA
Curve factor	C.F.		0.55			0.55			-
Capacitance	C _t	V = 0V, f = 1MHz		180			180		pF
Temperature coefficient of V _{oc}	t			- 2.2			- 2.2		mV/
Temperature coefficient of I _{sc}	t			0.18			0.18		%/
Spectral sensitivity			450 ~ 1,050			700 ~ 1,050			nm
Peak wavelength	λ		900			940			nm
Half angle			± 60			± 60			deg.

*2. Color temp. = 2856K standard Tungsten lamp

Photo diodes

HP - 3ML · HP - 3MLR2

Light current Vs. Forward voltage

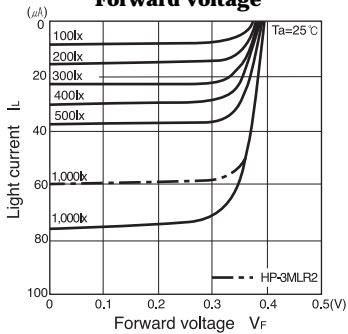

Short circuit current Vs. Illuminance

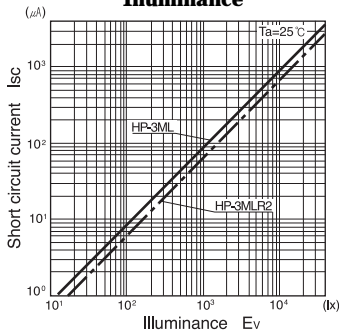

Dark current Vs. Ambient temperature

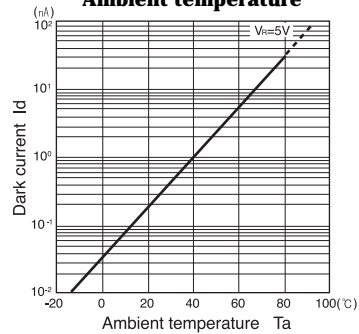

Relative sensitivity Vs. Wavelength

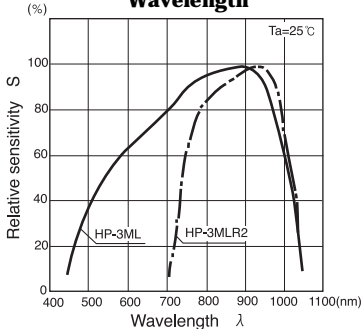

Dark current Vs. Reverse voltage

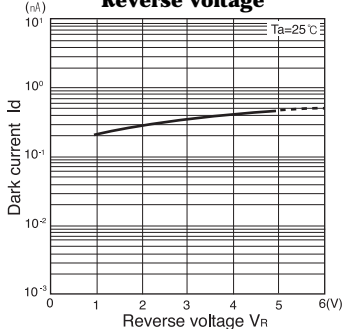

Radiant Pattern

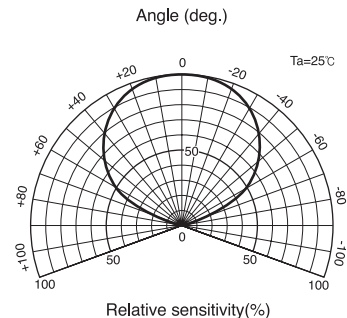

Capacitance between terminals Vs. Reverse voltage

