

IL2010B

PHASE CONTROL CIRCUIT FOR CURRENT FEEDBACK

Description

The IL2010B is designed as a phase-control circuit in bipolar technology. It enables load-current detection and has a soft-start function as well as reference voltage output. Motor control with load-current feedback and overload protection are preferred applications.

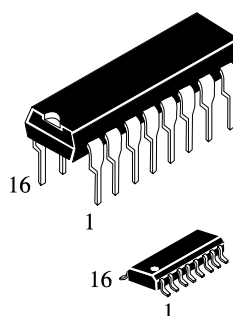

N SUFFIX
PLASTIC

D SUFFIX
SOIC

Features

- Full wave current sensing
- Mains supply variation compensated
- Programmable load-current limitation with over- and high-load output
- Variable soft-start
- Voltage and current synchronization
- Automatic retriggering switchable
- Triggering pulse typical 125 mA

- Internal supply voltage monitoring
- Current requirement ≤ 3 mA
- Temperature compensated reference voltage

Applications

- Advanced motor control
- Grinder
- Drilling machine

Pin Description

Pin	Symbol	Function
1	I_{sense}	Load current sensing
2	I_{sense}	Load current sensing
3	C_{ϕ}	Ramp voltage
4	Control	Control input
5	Comp.	Compensation output
6	I_{Load}	Load current limitation
7	C_{soft}	Soft start
8	V_{Ref}	Reference voltage
9	Mode	Mode selection
10	GND	Ground
11	V_S	Supply voltage
12	High load	High load indication
13	Overload	Overload indication
14	$V_{R\phi}$	Ramp current adjust
15	$V_{Sync.}$	Voltage synchronization
16	Output	Trigger output

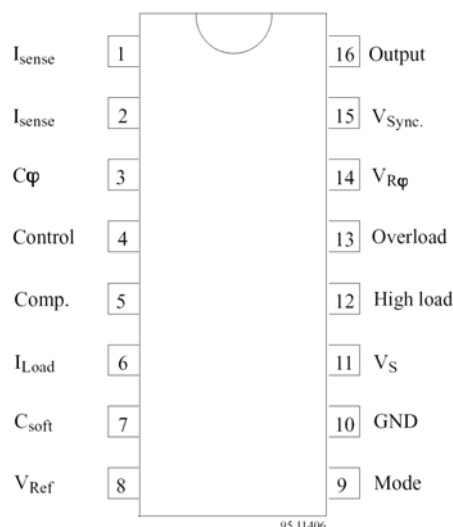

IL2010B

Block Diagram

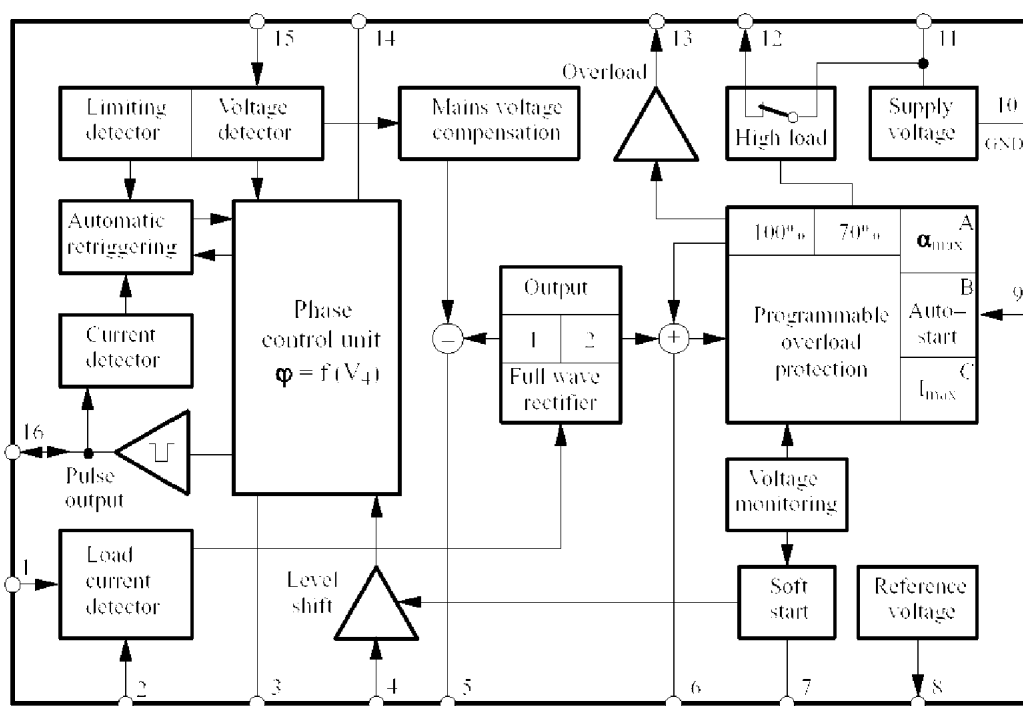

Absolute Maximum Ratings

Reference point Pin 10, unless otherwise specified

Parameters	Pin	Symbol	Value	Unit
Sink current	11	$-I_S$	30	mA
		$-i_S$	100	
Sync. currents	15	$\pm I_{syncV}$	5	mA
		$\pm i_{syncV}$	20	
Phase control				
Control voltage	4 and 8	$-V_i$	$0 - V_8$	V
Input current	4	$\pm I_i$	500	μ A
Charging current	14	$-I_{\phi max}$	0.5	mA
Soft-start				
Input voltage	7 and 8	$-V_i$	$0 - V_8$	V
Pulse output				
Input voltage	16	$+V_i$	2	V
		$-V_i$	V_{11}	
Reference voltage source				
Output current	8	I_o	10	mA
		i_o	30	
Load current sensing				
Input currents	1 and 2	$\pm I_i$	1	mA
Input voltages	5 and 6	$-V_i$	$0 - V_8$	V
Overload output	13	I_L	1	mA
High-load output	12	I_L	30	mA
		i_L	100	
Storage temperature range		T_{stg}	-40 to +125	$^{\circ}$ C
Junction temperature range		T_j	125	$^{\circ}$ C
Ambient temperature range		T_{amb}	-10 to +100	$^{\circ}$ C



Korzhenevskogo 12, Minsk, 220108, Republic of Belarus
 Fax: +375 (17) 278 28 22,
 Phone: +375 (17) 278 07 11, 212 24 70, 212 24 61,
 212 69 16
 E-mail: office@bms.by
 URL: www.bms.by

BELMICROSYSTEMS

IL2010B

Electrical Characteristics

$V_S = -13\text{ V}$, $T_{amb} = 25^\circ\text{C}$, reference point Pin 10, unless otherwise specified

Parameters	Test Conditions	Pins	Symbol	Min.	Typ.	Max.	Unit
Supply							
Supply voltage limitation	$-I_S = 5.5\text{ mA}$	11	$-V_S$	14.5		16.5	V
	$-I_S = 30\text{ mA}$			14.6		16.8	
Current requirement	$-V_S = 13.0\text{ V}$ (Pins 1, 2, 8 and 15 open) Pin 11		$-I_S$			5.2	mA
Reference voltage source							
Reference voltage	$I_L = 10\text{ uA}$	8	$-V_{Ref}$	8.7	9.0	9.3	V
	$I_L = 2.5\text{ mA}$			8.5	8.8	9.2	
Temperature coefficient	$I_S = 2.5\text{ mA}$		TC_{VRef}		-0.004		%/K
	$I_S = 10\text{ uA}$				+0.006		
Voltage monitoring							
Turn-on threshold		11	$-V_{Son}$		11.3	12.3	V
Phase control – synchronization							
Voltage limitation	$\pm I_L = 2\text{ mA}$		$\pm V_{syncV}$	8.0	8.5	9.0	V
Input current	Current sync.	16	$\pm I_{syncI}$	3		30	uA
Reference ramp, fig. 1							
Charging current		14	$-I_\phi$	1		100	uA
Start voltage		3	$-V_{max}$	2.00	2.15	2.20	V
Temperature coefficient of start voltage		3	TC_R		-0.003		%/K
Final voltage		3	$-V_{min}$	$(V_8 \pm 200\text{ mV})$			
R_ϕ reference voltage	$I_\phi = 10\text{ uA}$	14 and 11	$V_{R\phi}$	0.96	1.02	1.10	V
Temperature coefficient	$I_\phi = 10\text{ uA}$	14	$TC_{VR\phi}$		0.03		%/K
	$I_\phi = 1\text{ uA}$				0.06		
Pulse output current	$V_{16} = -1.2\text{ V}$, fig. 2,	16	I_0	100	125	150	mA
Output pulse width	$C_3 = 3.3\text{ nF}$, fig. 3	16	t_p		50		us
Automatic retriggering							
Repetition rate	$I_{15} = 150\text{ uA}$		t_{pp}	3	5	7.5	t_p
Threshold voltage		16	$\pm V_I$	20		100	mV
Soft start, figure 7 and 8							
Starting current	$V_7 = V_8$	7	$-I_0$	5	10	20	uA
Final current	$V_{7-10} = -1\text{ V}$		$-I_0$	20	25	50	uA
Discharge current			$+I_0$	0.5			mA
Output current		4	$+I_0$	0.2		2	mA
Supply voltage compensation,							
Transfer gain	fig. 6 I_{15}/I_5 Pin 15/5 (Pins 1 and 2 open)		G_i	12		18	
Output offset current	$V_{(R6)} = V_{15} = V_5 = 0$		$\pm I_0$			2	uA
Load current detection $R_1 = R_2 = 3\text{ k}\Omega$, $V_{15} = 0$, $V_5 = V_6 = V_8$, fig. 7							
Transfer gain	$I_5/150\text{ mV}$, $I_6/150\text{ mV}$		G_l	0.28	0.32	0.37	uA/mV
Output offset currents		5, 6 - 8	$-I_0$	0	3	6	uA
Reference voltage	$I_1, I_2 = 100\text{ uA}$	1 and 2	$-V_{Ref}$	300		450	mV
Shunt voltage amplitude			$\pm V_{(R6)}$			250	mV



IL2010B

Parameters	Test Conditions	Pins	Symbol	Min.	Typ.	Max.	Unit
Load current limitation figs. 8 to 13							
High load switching	Threshold V_{T70}	6-8	V_{T70}	4	4.35	4.7	V
Overload switching	Threshold V_{T100}		V_{T100}	5.8	6.2	6.6	V
Restart switching	Threshold V_{T25}		V_{T25}	1.25	1.55	1.85	V
Input current	Enquiry mode		I_i			1	uA
Output impedance	Switching mode		R_0	2	4	8	k Ω
Programming input							
Input voltage - auto-start	Pin 9 open	9	$-V_9$	3.8	4.3	4.7	V
Input current	$V_9 = 0$ (α_{max})		$-I_9$	5	10	20	uA
	$V_9 = V_8$ (I_{max})		I_9	5	10	20	
High load output , V_{T70} , fig. 9, $I_{12} = -3$ mA,							
Saturation voltages	$V_{6-8} \leq V_{T70}$	11-12	V_{sat}	0.5	0.75	1.0	V
	$V_{6-8} \geq V_{T70}$		V_{lim}	7.3		8.1	
Overload output , V_{T100} , $V_9 =$ open or $V_9 = V_{10}$, fig. 10							
Leakage current	$V_{6-8} \geq V_{T25}$ $V_{13} = (V_{11}+1)V$	13	I_{lkg}			0.5	uA
Saturation voltages	$V_{6-8} \geq V_{T100}$, $I_{13} = 10$ uA	11-13	V_{sat}			0.15	V
Output current, max. load	$V_9 = V_8$, fig. 10	13	I_{13}			1	mA
Leakage current	$V_6 \leq V_{T100}$	13	I_{lkg}			4	uA
Output impedance	Open collector $V_6 \leq V_{T100}$	13	R_0	2	4	8	k Ω

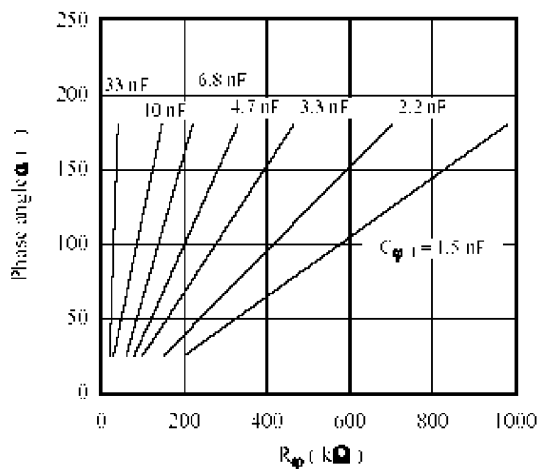

Fig.1

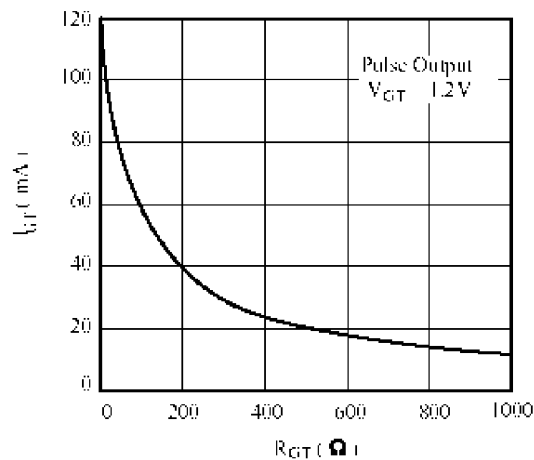

Fig.2



IL2010B

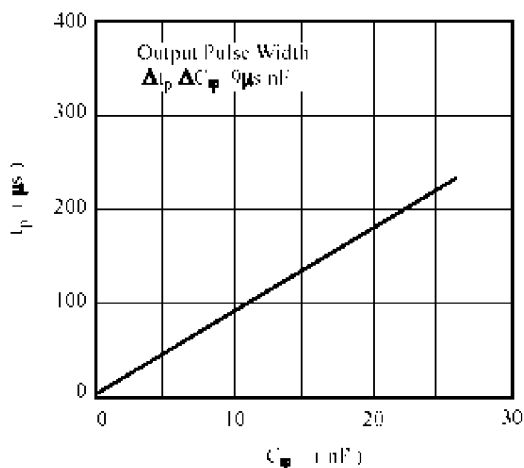

Fig.3

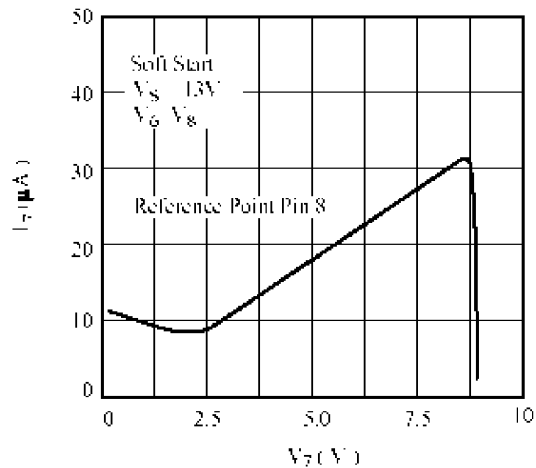

Fig.4

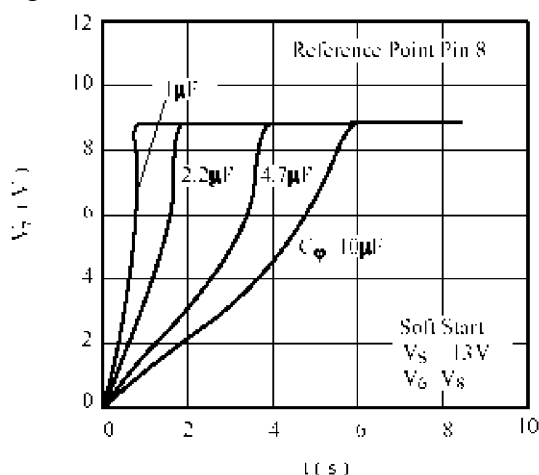

Fig.5

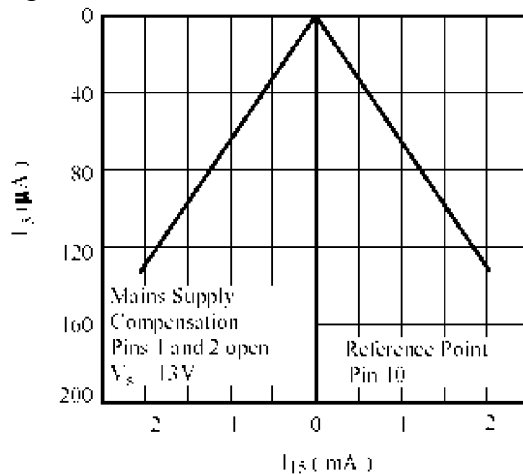

Fig.6

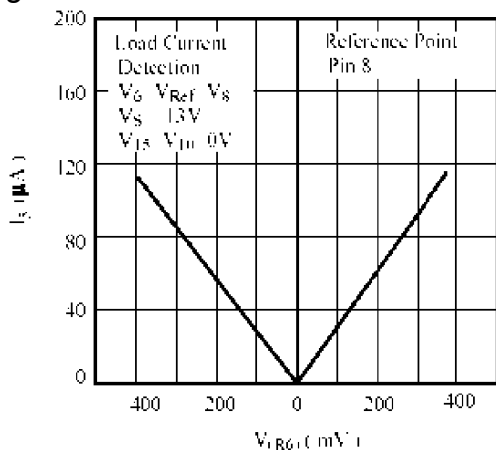

Fig.7

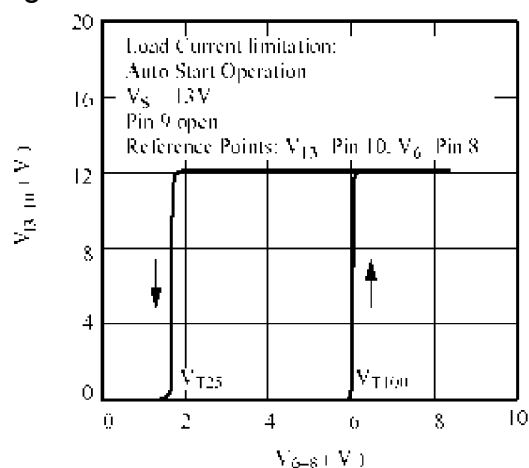

Fig.8



IL2010B

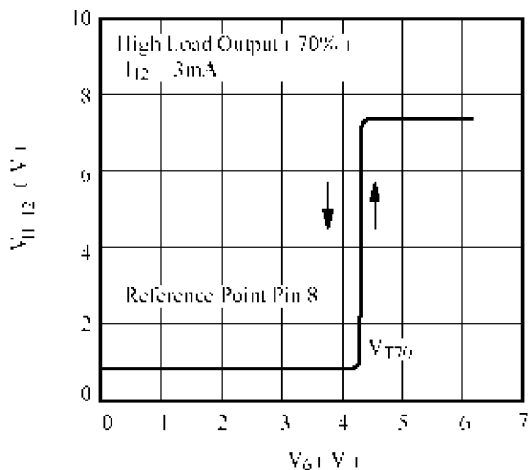

Fig.9

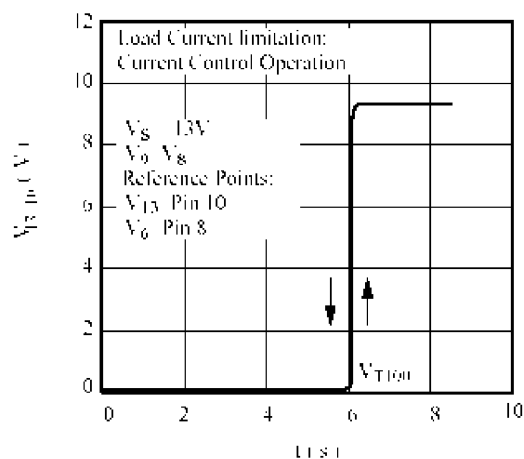

Fig.10

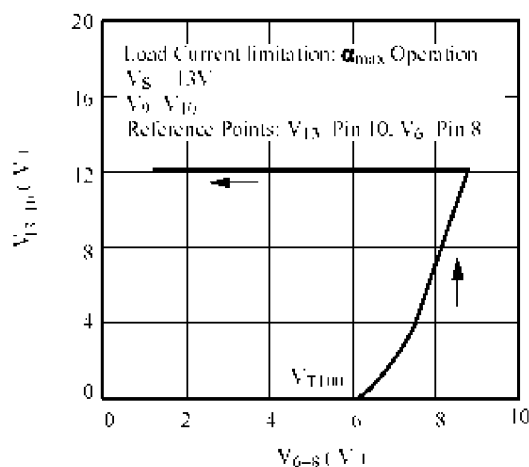

Fig.11

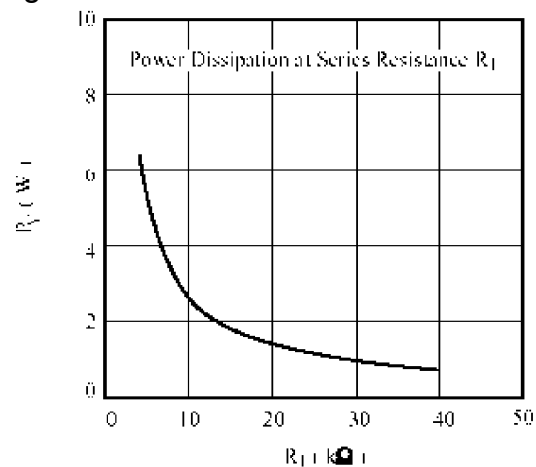

Fig.12

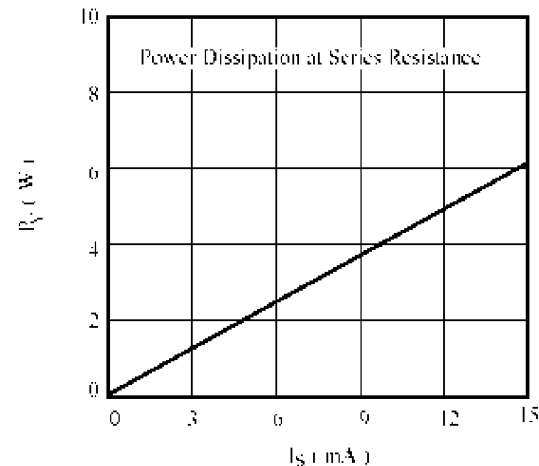

Fig.13

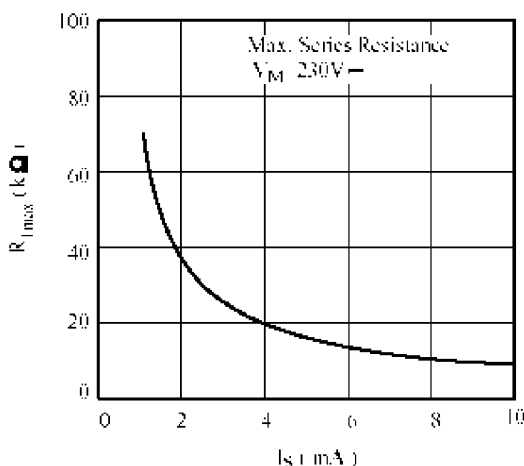
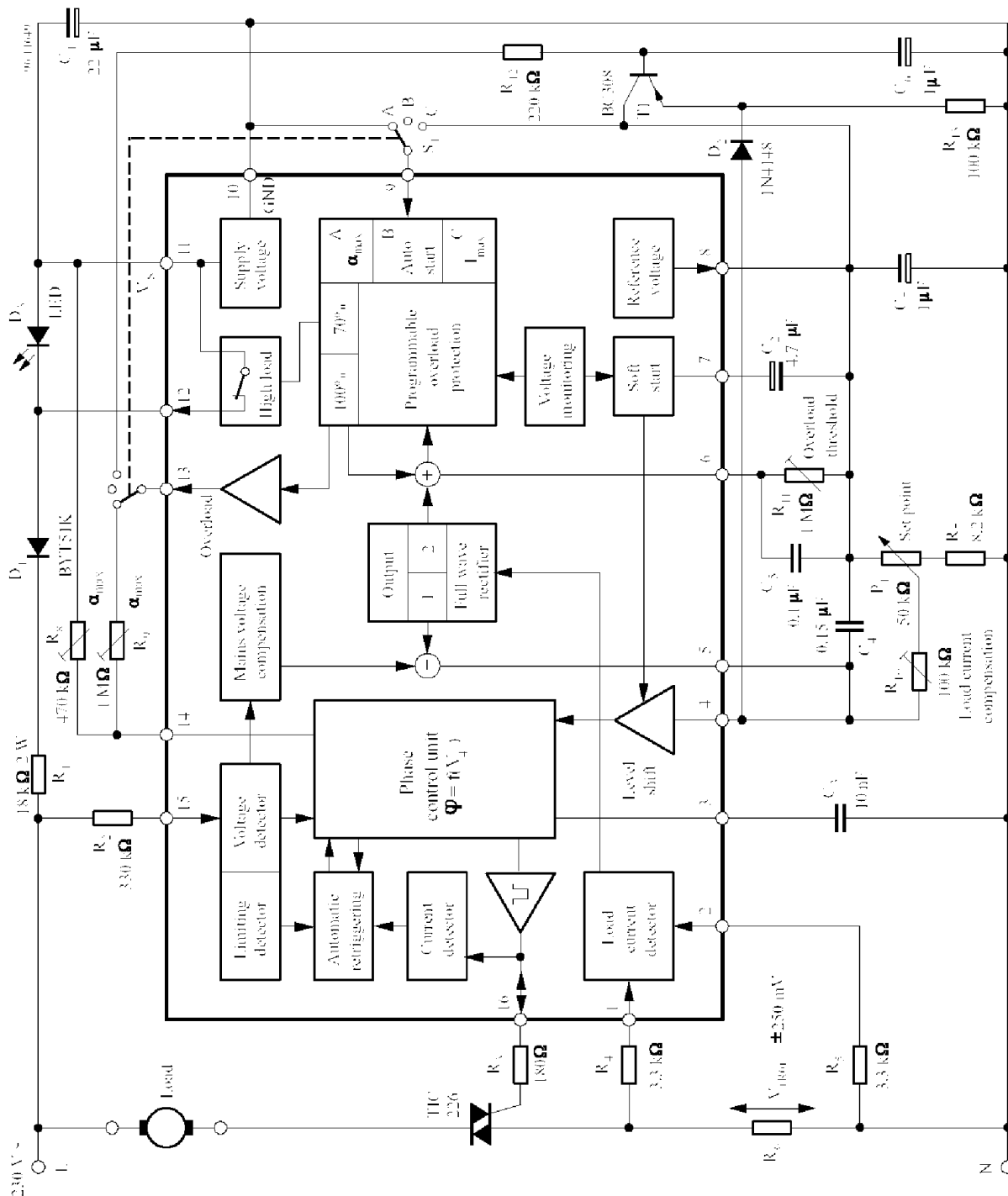

Fig.14



IL2010B



Korzhenevskogo 12, Minsk, 220108, Republic of Belarus
 Fax: +375 (17) 278 28 22,
 Phone: +375 (17) 278 07 11, 212 24 70, 212 24 61,
 212 69 16
 E-mail: office@bms.by
 URL: www.bms.by

BELMICROSYSTEMS