

CoolMOS™ Power Transistor
Features

- Lowest figure-of-merit $R_{ON} \times Q_g$
- Ultra low gate charge
- Extreme dv/dt rated
- High peak current capability
- Qualified according to JEDEC⁽¹⁾ for target applications
- Pb-free lead plating; RoHS compliant

Product Summary

| | | |
|----------------------|-------|----------|
| $V_{DS} @ T_{j,max}$ | 650 | V |
| $R_{DS(on),max}$ | 0.199 | Ω |
| $Q_{g,typ}$ | 33 | nC |

CoolMOS CP is specially designed for:

- Hard switching topologies, for Server and Telecom

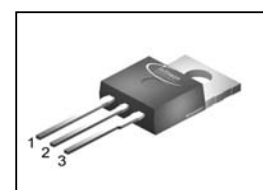
PG-TO220

| Type | Package | Ordering Code | Marking |
|-------------|----------|---------------|---------|
| IPP60R199CP | PG-TO220 | SP000084278 | 6R199P |

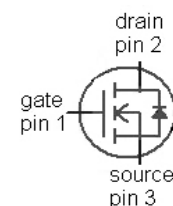
Maximum ratings, at $T_j=25\text{ °C}$, unless otherwise specified

| Parameter | Symbol | Conditions | Value | Unit |
|--|----------------|--|-------------|--------------------|
| Continuous drain current | I_D | $T_C=25\text{ °C}$ | 16 | A |
| | | $T_C=100\text{ °C}$ | 10 | |
| Pulsed drain current ⁽²⁾ | $I_{D,pulse}$ | $T_C=25\text{ °C}$ | 51 | |
| Avalanche energy, single pulse | E_{AS} | $I_D=6.6\text{ A}, V_{DD}=50\text{ V}$ | 436 | mJ |
| Avalanche energy, repetitive t_{AR} ^(2),3) | E_{AR} | $I_D=6.6\text{ A}, V_{DD}=50\text{ V}$ | 0.66 | |
| Avalanche current, repetitive t_{AR} ^(2),3) | I_{AR} | | 6.6 | A |
| MOSFET dv/dt ruggedness | dv/dt | $V_{DS}=0\dots480\text{ V}$ | 50 | V/ns |
| Gate source voltage | V_{GS} | static | ± 20 | V |
| | | AC ($f > 1\text{ Hz}$) | ± 30 | |
| Power dissipation | P_{tot} | $T_C=25\text{ °C}$ | 139 | W |
| Operating and storage temperature | T_j, T_{stg} | | -55 ... 150 | $^{\circ}\text{C}$ |
| Mounting torque | | M3 and M3.5 screws | 60 | Ncm |

Maximum ratings, at $T_j=25\text{ °C}$, unless otherwise specified

| Parameter | Symbol | Conditions | Value | Unit |
|-------------------------------------|---------------|--------------------|-------|------|
| Continuous diode forward current | I_S | $T_C=25\text{ °C}$ | 9.9 | A |
| Diode pulse current ²⁾ | $I_{S,pulse}$ | | 51 | |
| Reverse diode dv/dt ⁴⁾ | dv/dt | | 15 | V/ns |

| Parameter | Symbol | Conditions | Values | | | Unit |
|-----------|--------|------------|--------|------|------|------|
| | | | min. | typ. | max. | |

Thermal characteristics

| | | | | | | |
|--|------------|---------------------------------------|---|---|-----|-----|
| Thermal resistance, junction - case | R_{thJC} | | - | - | 0.9 | K/W |
| Thermal resistance, junction - ambient | R_{thJA} | leaded | - | - | 62 | |
| Soldering temperature, wavesoldering only allowed at leads | T_{sold} | 1.6 mm (0.063 in.) from case for 10 s | - | - | 260 | °C |

Electrical characteristics, at $T_j=25\text{ °C}$, unless otherwise specified

Static characteristics

| | | | | | | |
|----------------------------------|---------------|---|-----|------|-------|---------------|
| Drain-source breakdown voltage | $V_{(BR)DSS}$ | $V_{GS}=0\text{ V}$, $I_D=250\text{ }\mu\text{A}$ | 600 | - | - | V |
| Gate threshold voltage | $V_{GS(th)}$ | $V_{DS}=V_{GS}$, $I_D=1.1\text{ mA}$ | 2.5 | 3 | 3.5 | |
| Zero gate voltage drain current | I_{DSS} | $V_{DS}=600\text{ V}$, $V_{GS}=0\text{ V}$, $T_j=25\text{ °C}$ | - | - | 1 | μA |
| | | $V_{DS}=600\text{ V}$, $V_{GS}=0\text{ V}$, $T_j=150\text{ °C}$ | - | 10 | - | |
| Gate-source leakage current | I_{GSS} | $V_{GS}=20\text{ V}$, $V_{DS}=0\text{ V}$ | - | - | 100 | nA |
| Drain-source on-state resistance | $R_{DS(on)}$ | $V_{GS}=10\text{ V}$, $I_D=9.9\text{ A}$, $T_j=25\text{ °C}$ | - | 0.18 | 0.199 | Ω |
| | | $V_{GS}=10\text{ V}$, $I_D=9.9\text{ A}$, $T_j=150\text{ °C}$ | - | 0.49 | - | |
| Gate resistance | R_G | $f=1\text{ MHz}$, open drain | - | 2 | - | Ω |

| Parameter | Symbol | Conditions | Values | | | Unit |
|-----------|--------|------------|--------|------|------|------|
| | | | min. | typ. | max. | |

Dynamic characteristics

| | | | | | | |
|--|--------------|--|---|------|---|----|
| Input capacitance | C_{iss} | $V_{GS}=0\text{ V}, V_{DS}=100\text{ V},$ $f=1\text{ MHz}$ | - | 1520 | - | pF |
| Output capacitance | C_{oss} | | - | 72 | - | |
| Effective output capacitance, energy related ⁵⁾ | $C_{o(er)}$ | $V_{GS}=0\text{ V}, V_{DS}=0\text{ V}$ to 480 V | - | 69 | - | |
| Effective output capacitance, time related ⁶⁾ | $C_{o(tr)}$ | | - | 180 | - | |
| Turn-on delay time | $t_{d(on)}$ | $V_{DD}=400\text{ V},$ $V_{GS}=10\text{ V}, I_D=9.9\text{ A},$ $R_G=3.3\ \Omega$ | - | 10 | - | ns |
| Rise time | t_r | | - | 5 | - | |
| Turn-off delay time | $t_{d(off)}$ | | - | 50 | - | |
| Fall time | t_f | | - | 5 | - | |

Gate Charge Characteristics

| | | | | | | |
|-----------------------|---------------|--|---|-----|----|----|
| Gate to source charge | Q_{gs} | $V_{DD}=400\text{ V}, I_D=9.9\text{ A},$ $V_{GS}=0\text{ to }10\text{ V}$ | - | 8 | - | nC |
| Gate to drain charge | Q_{gd} | | - | 11 | - | |
| Gate charge total | Q_g | | - | 32 | 43 | |
| Gate plateau voltage | $V_{plateau}$ | | - | 5.0 | - | V |

Reverse Diode

| | | | | | | |
|-------------------------------|-----------|--|---|-----|-----|---------------|
| Diode forward voltage | V_{SD} | $V_{GS}=0\text{ V}, I_F=9.9\text{ A},$ $T_j=25\text{ }^\circ\text{C}$ | - | 0.9 | 1.2 | V |
| Reverse recovery time | t_{rr} | $V_R=400\text{ V}, I_F=I_S,$ $di_F/dt=100\text{ A}/\mu\text{s}$ | - | 340 | - | ns |
| Reverse recovery charge | Q_{rr} | | - | 5.5 | - | μC |
| Peak reverse recovery current | I_{rrm} | | - | 33 | - | A |

¹⁾ J-STD20 and JESD22

²⁾ Pulse width t_p limited by $T_{j,max}$
³⁾ Repetitive avalanche causes additional power losses that can be calculated as $P_{AV}=E_{AR} \cdot f$.

⁴⁾ $I_{SD} < I_D$, $di/dt < 200\text{ A}/\mu\text{s}$, $V_{DClink}=400\text{ V}$, $V_{peak} < V_{(BR)DSS}$, $T_j < T_{j,max}$, identical low side and high side switch.

⁵⁾ $C_{o(er)}$ is a fixed capacitance that gives the same stored energy as C_{oss} while V_{DS} is rising from 0 to 80% V_{DSS} .

⁶⁾ $C_{o(tr)}$ is a fixed capacitance that gives the same charging time as C_{oss} while V_{DS} is rising from 0 to 80% V_{DSS} .

1 Power dissipation

$$P_{tot} = f(T_C)$$

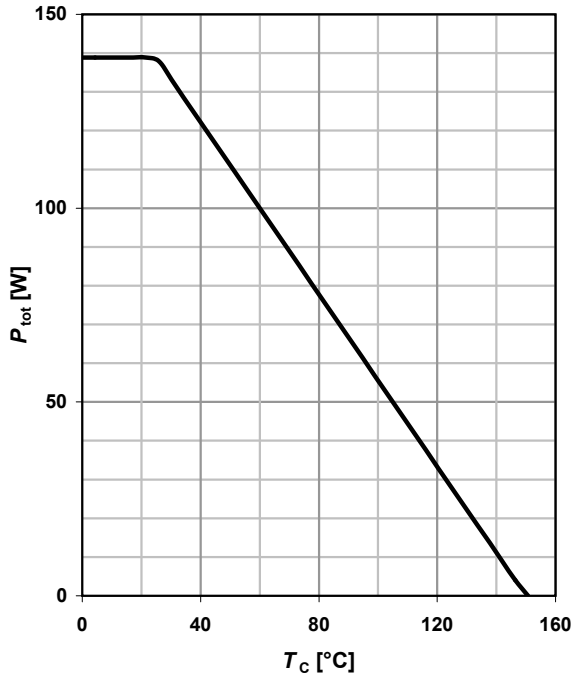

2 Safe operating area

$$I_D = f(V_{DS}); T_C = 25^\circ\text{C}; D = 0$$

parameter: t_p

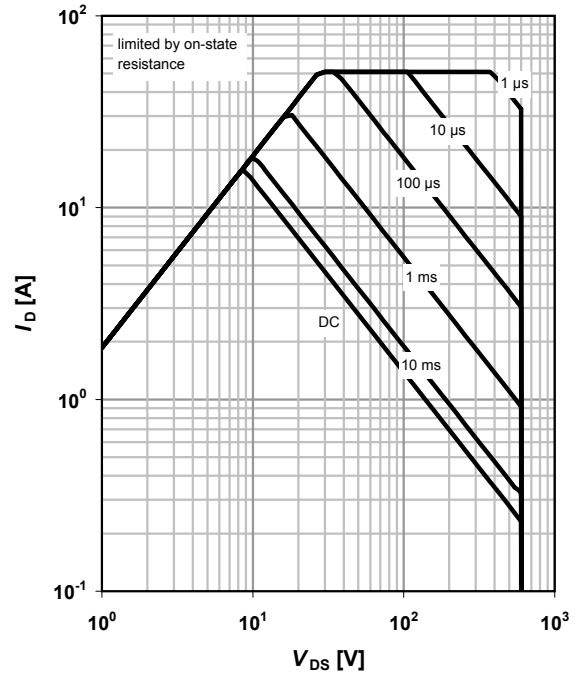

3 Max. transient thermal impedance

$$Z_{thJC} = f(t_p)$$

parameter: $D = t_p / T$

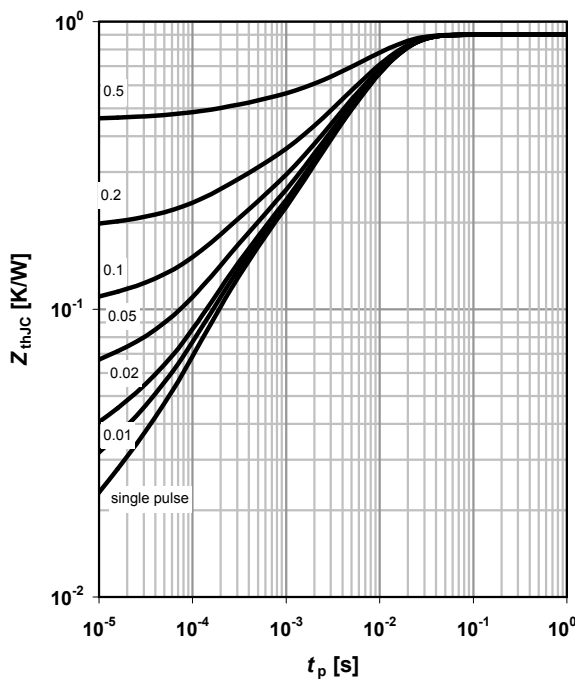

4 Typ. output characteristics

$$I_D = f(V_{DS}); T_j = 25^\circ\text{C}$$

parameter: V_{GS}

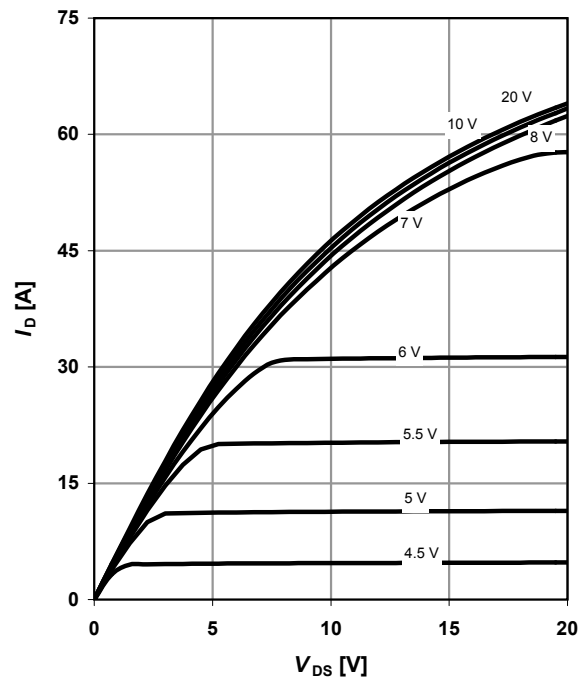

5 Typ. output characteristics

$I_D = f(V_{DS}); T_j = 150\text{ }^\circ\text{C}$

parameter: V_{GS}

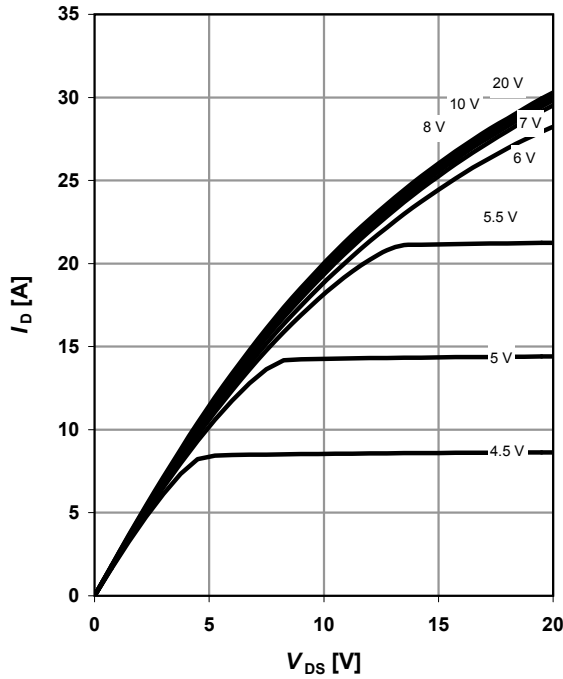

6 Typ. drain-source on-state resistance

$R_{DS(on)} = f(I_D); T_j = 150\text{ }^\circ\text{C}$

parameter: V_{GS}

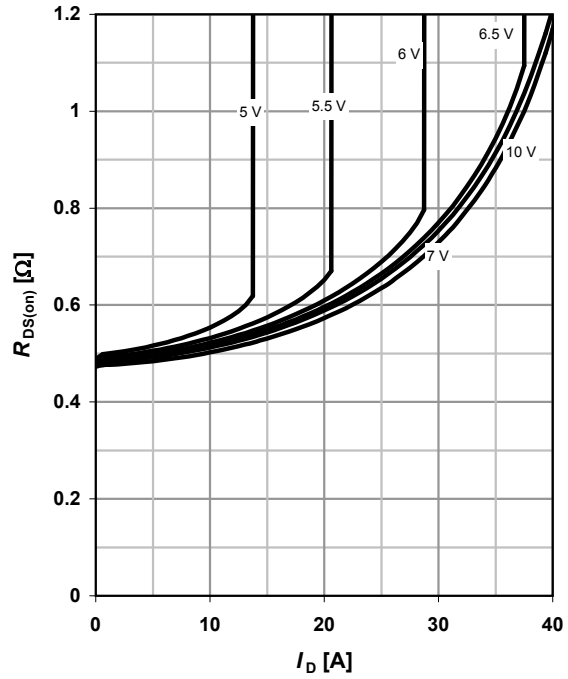

7 Drain-source on-state resistance

$R_{DS(on)} = f(T_j); I_D = 9.9\text{ A}; V_{GS} = 10\text{ V}$

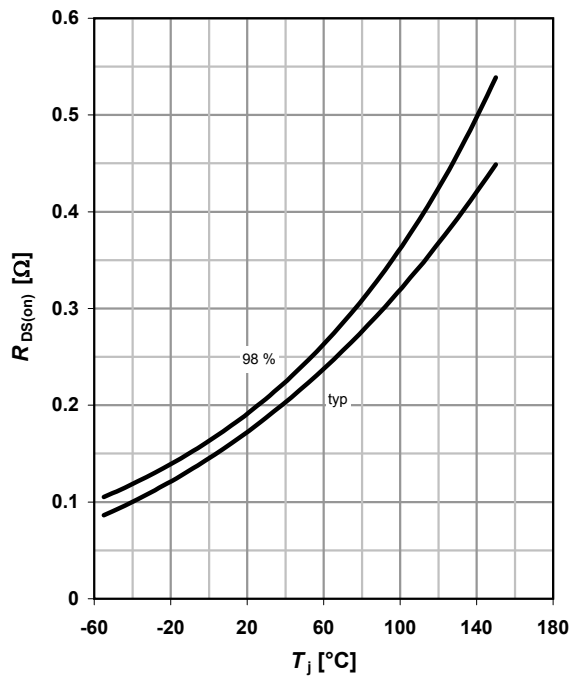

8 Typ. transfer characteristics

$I_D = f(V_{GS}); |V_{DS}| > 2|I_D|R_{DS(on)max}$

parameter: T_j

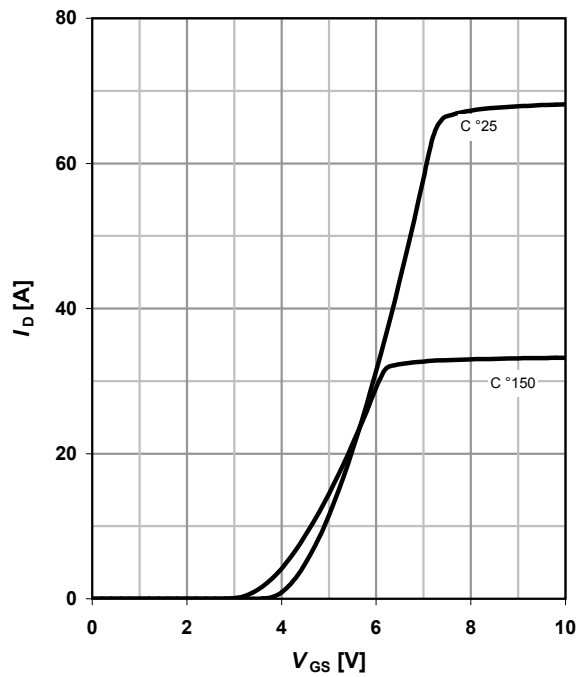

9 Typ. gate charge

$V_{GS}=f(Q_{gate}); I_D=9.9 \text{ A pulsed}$

parameter: V_{DD}

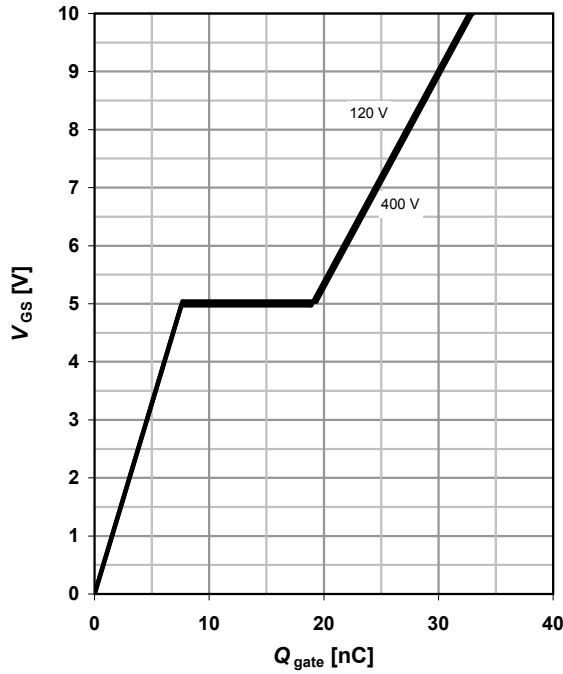

10 Forward characteristics of reverse diode

$I_F=f(V_{SD})$

parameter: T_j

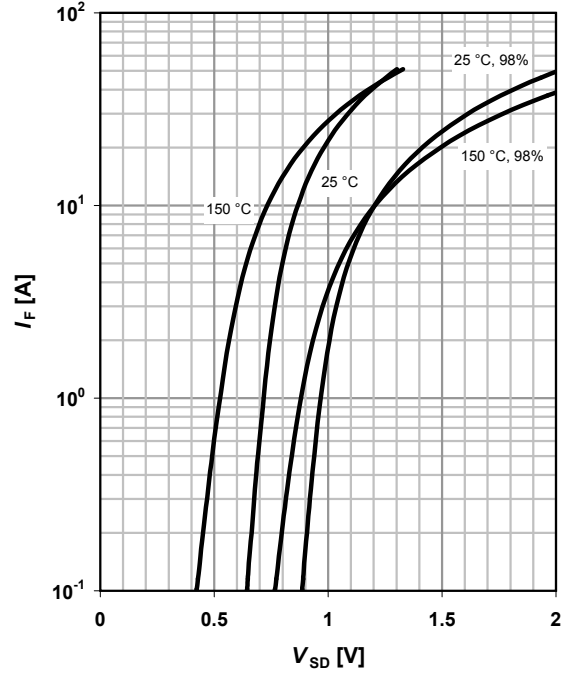

11 Avalanche energy

$E_{AS}=f(T_j); I_D=6.6 \text{ A}; V_{DD}=50 \text{ V}$

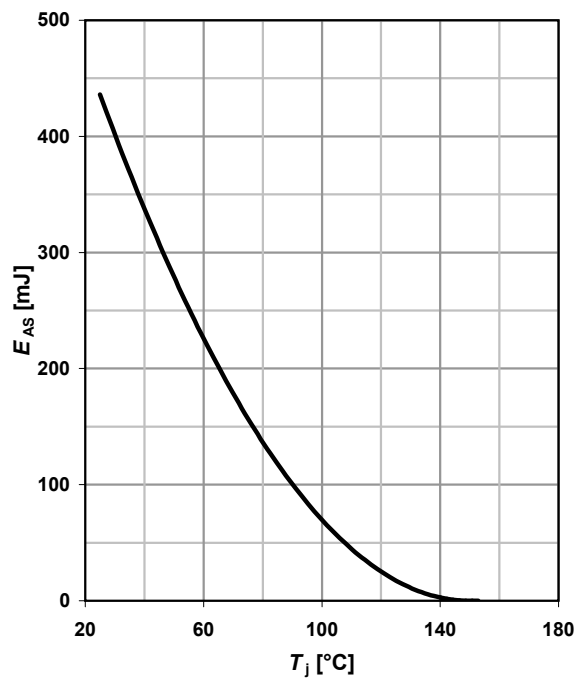

12 Drain-source breakdown voltage

$V_{BR(DSS)}=f(T_j); I_D=0.25 \text{ mA}$

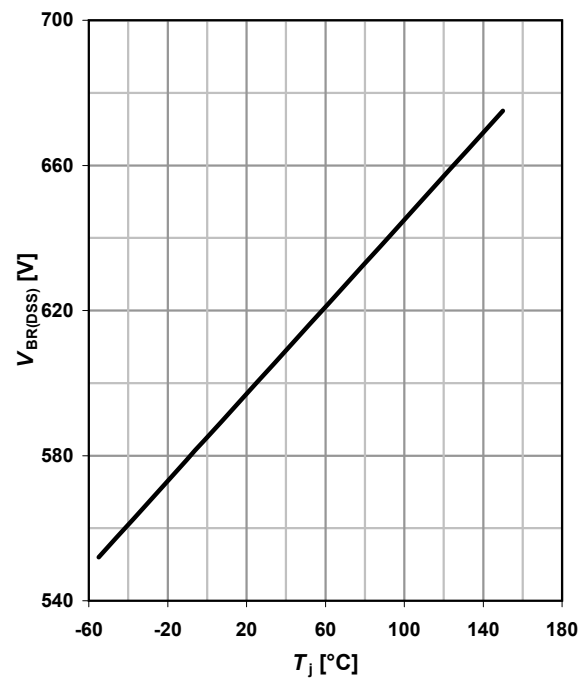

13 Typ. capacitances

$C=f(V_{DS}); V_{GS}=0\text{ V}; f=1\text{ MHz}$

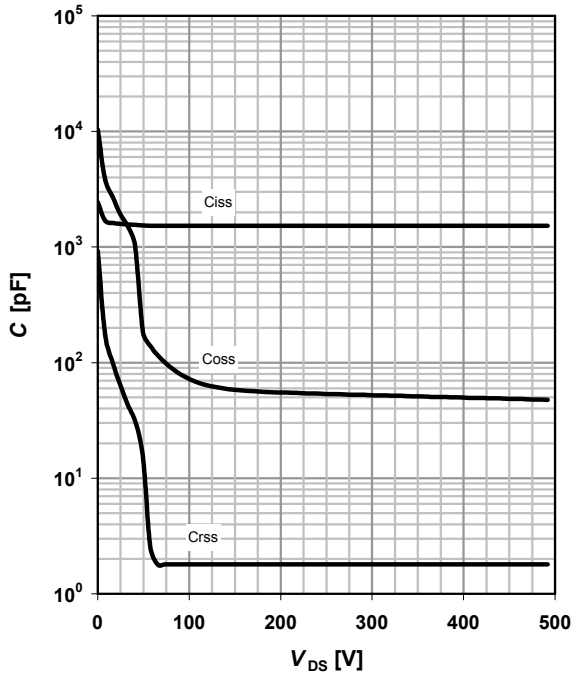

14 Typ. Coss stored energy

$E_{oss}=f(V_{DS})$

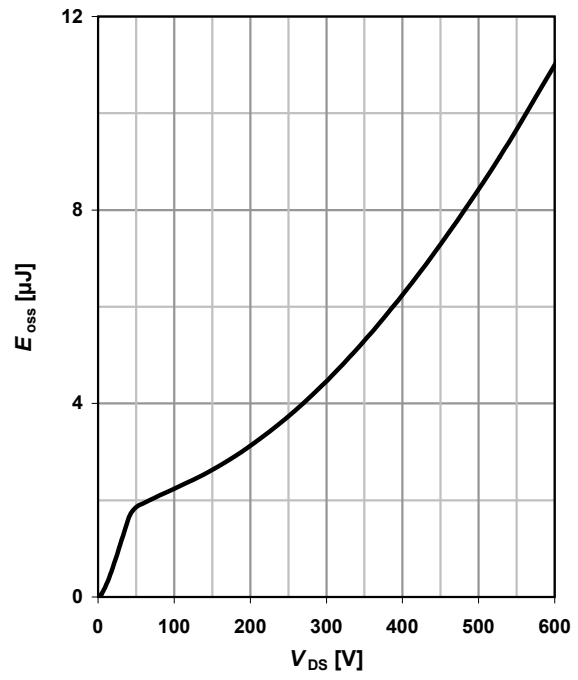

Definition of diode switching characteristics

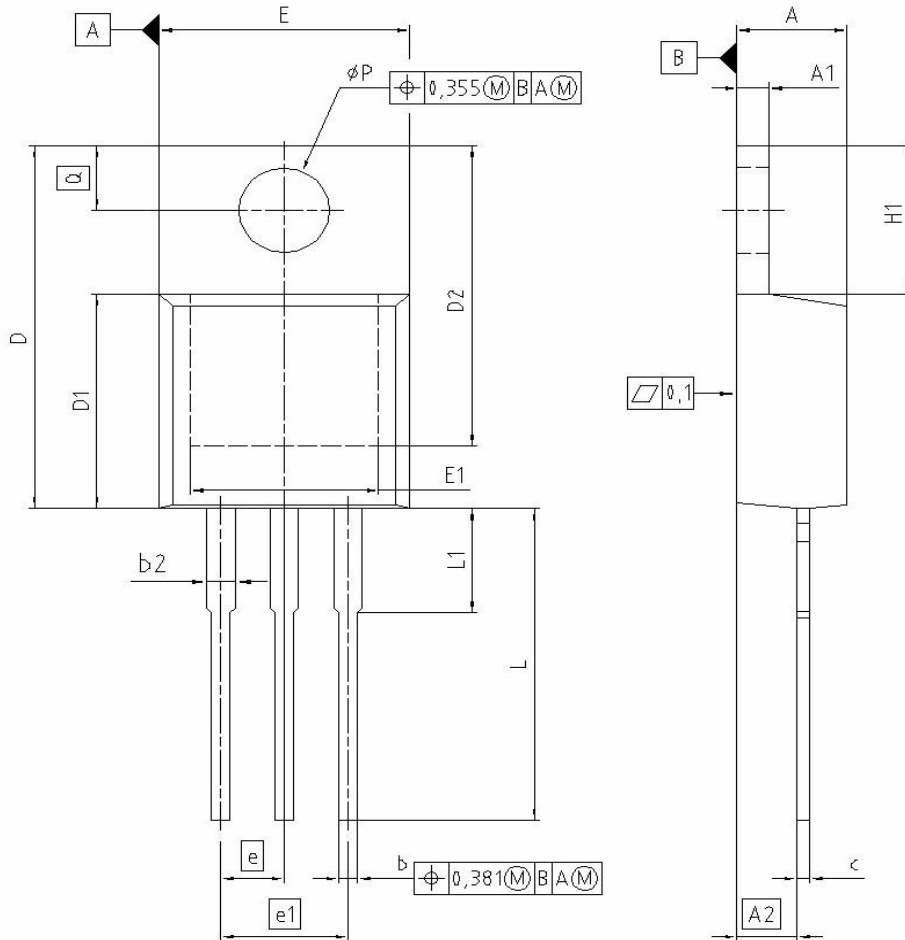

PG-TO220-3-1/TO220-3-21: Outlines

| DIM | MILLIMETERS | | INCHES | |
|-----|-------------|--------|--------|-------|
| | MIN | MAX | MIN | MAX |
| A | 4.300 | 4.572 | 0.169 | 0.180 |
| A1 | 1.170 | 1.400 | 0.046 | 0.055 |
| A2 | 2.215 | 2.718 | 0.087 | 0.107 |
| b | 0.650 | 0.864 | 0.026 | 0.034 |
| b2 | 0.635 | 1.778 | 0.025 | 0.070 |
| c | 0.330 | 0.600 | 0.013 | 0.024 |
| D | 14.808 | 15.950 | 0.583 | 0.628 |
| D1 | 8.509 | 9.450 | 0.335 | 0.372 |
| D2 | 12.850 | 13.100 | 0.506 | 0.516 |
| E | 9.700 | 10.363 | 0.382 | 0.408 |
| E1 | 6.500 | 8.600 | 0.256 | 0.339 |
| e | 2.540 | | 0.100 | |
| e1 | 5.080 | | 0.200 | |
| N | 3 | | 3 | |
| H1 | 5.900 | 6.900 | 0.232 | 0.272 |
| L | 13.000 | 14.000 | 0.512 | 0.551 |
| L1 | - | 4.800 | - | 0.189 |
| pP | 3.700 | 3.886 | 0.146 | 0.153 |
| Q | 2.600 | 3.000 | 0.102 | 0.118 |

REFERENCE
JEDEC TO220

SCALE

EUROPEAN PROJECTION

ISSUE DATE
01-06-2005

FILE
TO220_1

Dimensions in mm/inches

Published by
Infineon Technologies AG
81726 München, Germany
© Infineon Technologies AG 2006.
All Rights Reserved.

Attention please!

The information given in this data sheet shall in no event be regarded as a guarantee of conditions or characteristics ("Beschaffenheitsgarantie"). With respect to any examples or hints given herein, any typical values stated herein and/or any information regarding the application of the device, Infineon Technologies hereby disclaims any and all warranties and liabilities of any kind, including without limitation warranties of non-infringement of intellectual property rights of any third party.

Information

For further information on technology, delivery terms and conditions and prices please contact your nearest Infineon Technologies Office (www.infineon.com).

Warnings

Due to technical requirements components may contain dangerous substances. For information on the types in question please contact your nearest Infineon Technologies Office.

Infineon Technologies Components may only be used in life-support devices or systems with the express written approval of Infineon Technologies, if a failure of such components can reasonably be expected to cause the failure of that life-support device or system, or to affect the safety or effectiveness of that device or system. Life support devices or systems are intended to be implanted in the human body, or to support and/or maintain and sustain and/or protect human life. If they fail, it is reasonable to assume that the health of the user or other persons may be endangered.