

INTERNATIONAL RECTIFIER 

HEXFET® TRANSISTORS

IRF224
IRF225

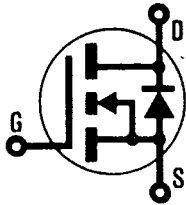

N-CHANNEL

250 Volt, 1.1 Ohm HEXFET

The HEXFET® technology is the key to International Rectifier's advanced line of power MOSFET transistors. The efficient geometry and unique processing of the HEXFET design achieve very low on-state resistance combined with high transconductance and great device ruggedness.

The HEXFET transistors also feature all of the well established advantages of MOSFETs such as voltage control, very fast switching, ease of paralleling, and temperature stability of the electrical parameters.

They are well suited for applications such as motor controls, inverters, choppers and audio amplifiers. The voltage rating makes them cost effective for the 115 volt offline switching applications like battery chargers, hand drills, lighting ballasts, washing machines and dryers.

Features

- Fast Switching
- Low Drive Current
- Low R_{DS(on)}
- High Reverse Energy
- Excellent Temperature Stability
- Ease of Paralleling

Product Summary

Part Number	V _{DS}	R _{DS(on)}	I _D
IRF224	250V	1.1Ω	3.8A
IRF225	250V	1.5Ω	3.3A

CASE STYLE AND DIMENSIONS

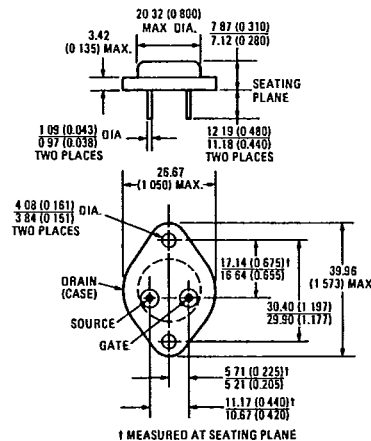
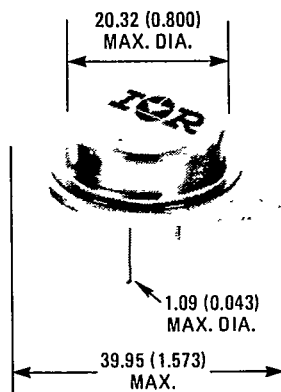

Conforms to JEDEC Outline TO-204AA (TO-3)
Dimensions in Millimeters and (Inches)



Absolute Maximum Ratings

Parameter	IRF224	IRF225	Units
V _{DS} Drain - Source Voltage ①	250	250	V
V _{DGR} Drain - Gate Voltage (R _{GS} = 20 kΩ) ①	250	250	V
I _D @ T _C = 25°C Continuous Drain Current	3.8	3.3	A
I _D @ T _C = 100°C Continuous Drain Current	2.4	2.1	A
I _{DM} Pulsed Drain Current ②	15	13	A
V _{GS} Gate - Source Voltage	±20		V
P _D @ T _C = 25°C Max. Power Dissipation	40		W
Linear Derating Factor	0.32		W/K ③
I _{LM} Inductive Current, Clamped	15 (See Fig. 14) L = 100μH	13	A
I _L Unclamped Inductive Current (Avalanche Current)③	2.2 (See Fig. 15)		A
T _J Operating Junction and Storage Temperature Range	-55 to 150		°C
T _{stg} Lead Temperature	300 (0.063 in. (1.6mm) from case for 10s)		°C

Electrical Characteristics @ T_C = 25°C Unless Otherwise Noted

Parameter	Type	Min.	Typ.	Max.	Units	Test Conditions
BV _{DSS} Drain - Source Breakdown Voltage	IRF224 IRF225	250	—	—	V	V _{GS} = 0V I _D = 250 μA
V _{GS(th)} Gate Threshold Voltage	ALL	2.0	—	4.0	V	V _{DS} = V _{GS} ; I _D = 250 μA
I _{GSS} Gate-Source Leakage Forward	ALL	—	—	100	nA	V _{GS} = 20V
I _{GSS} Gate-Source Leakage Reverse	ALL	—	—	-100	nA	V _{GS} = -20V
I _{DSS} Zero Gate Voltage Drain Current	ALL	—	—	250	μA	V _{DS} = Max. Rating, V _{GS} = 0V
I _{D(on)} On-State Drain Current ④	IRF224 IRF225	3.8 3.3	— —	— —	A	V _{DS} = Max. Rating × 0.8, V _{GS} = 0V, T _C = 125°C
R _{DS(on)} Static Drain-Source On-State Resistance ④	IRF224 IRF225	— —	0.79 1.1	1.1 1.5	Ω	V _{GS} = 10V, I _D = 2.1A
g _{fs} Forward Transconductance ④	ALL	1.4	2.1	—	S(Ω)	V _{DS} = 2×V _{GS} , I _{DS} = 1.9A
C _{iss} Input Capacitance	ALL	—	340	—	pF	V _{GS} = 0V, V _{DS} = 25V, f = 1.0 MHz
C _{oss} Output Capacitance	ALL	—	110	—	pF	See Fig. 10
C _{rss} Reverse Transfer Capacitance	ALL	—	32	—	pF	
t _{d(on)} Turn-On Delay Time	ALL	—	11	17	ns	V _{DD} = 125V, I _D ≈ 3.8A, R _G = 18Ω, R _D = 32Ω
t _r Rise Time	ALL	—	24	36	ns	See Fig. 16
t _{d(off)} Turn-Off Delay Time	ALL	—	21	32	ns	(MOSFET switching times are essentially independent of operating temperature.)
t _f Fall Time	ALL	—	13	20	ns	
Q _g Total Gate Charge (Gate-Source Plus Gate-Drain)	ALL	—	15	22	nC	V _{GS} = 10V, I _D = 3.8A, V _{DS} = 0.8 Max. Rating. See Fig. 17 for test circuit. (Gate charge is essentially independent of operating temperature.)
Q _{gs} Gate-Source Charge	ALL	—	4.0	6.0	nC	
Q _{gd} Gate-Drain ("Miller") Charge	ALL	—	7.2	11	nC	
L _D Internal Drain Inductance	ALL	—	5.0	—	nH	Measured from the drain lead, 6mm (0.25 in.) from package to center of die.
L _S Internal Source Inductance	ALL	—	13	—	nH	Measured from the source lead, 6mm (0.25 in.) from package to source bonding pad.

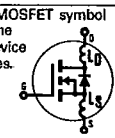

Thermal Resistance

R _{thJC} Junction-to-Case	ALL	—	—	3.12	K/W ⑤	
R _{thCS} Case-to-Sink	ALL	—	0.15	—	K/W ⑤	Mounting surface flat, smooth, and greased.
R _{thJA} Junction-to-Ambient	ALL	—	—	30	K/W ⑤	Typical socket mount

Source-Drain Diode Ratings and Characteristics

I _S	Continuous Source Current (Body Diode)	IRF224	—	—	3.8	A	Modified MOSFET symbol showing the integral reverse P-N junction rectifier. 
		IRF225	—	—	3.3	A	
I _{SM}	Pulse Source Current (Body Diode) ③	IRF224	—	—	15	A	T _C = 25°C, I _S = 3.8A, V _{GS} = 0V
		IRF225	—	—	13	A	
V _{SD}	Diode Forward Voltage ②	ALL	—	—	1.8	V	T _J = 25°C, I _F = 3.8A, dI _F /dt = 100A/μs
t _{rr}	Reverse Recovery Time	ALL	81	180	370	ns	T _J = 25°C, I _F = 3.8A, dI _F /dt = 100A/μs
Q _{RR}	Reverse Recovered Charge	ALL	0.44	0.93	2.0	μC	T _J = 25°C, I _F = 3.8A, dI _F /dt = 100A/μs
t _{on}	Forward Turn-on Time	ALL	Intrinsic turn-on time is negligible. Turn-on speed is substantially controlled by L _S + L _D .				

① T_J = 25°C to 150°C

② Repetitive Rating: Pulse width limited by max. junction temperature. See Transient Thermal Response Curve (Fig. 5)

③ V_{dd} = 50 V Starting T_J = 25°C
L = 100 μH R_G = 25Ω

④ Pulse Test: Pulse width ≤ 300 μs
Duty Cycle ≤ 2%.

⑤ KW = °C/W
W/K = W/°C

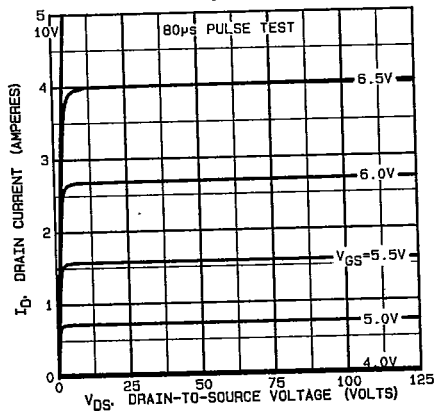

Fig. 1 — Typical Output Characteristics

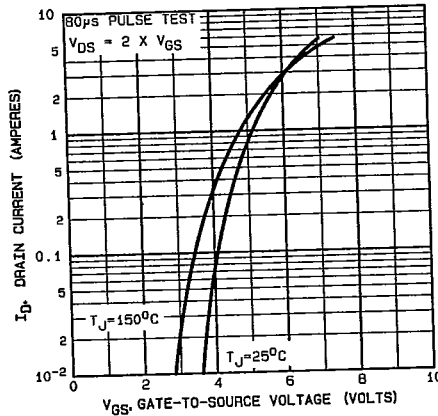

Fig. 2 — Typical Transfer Characteristics

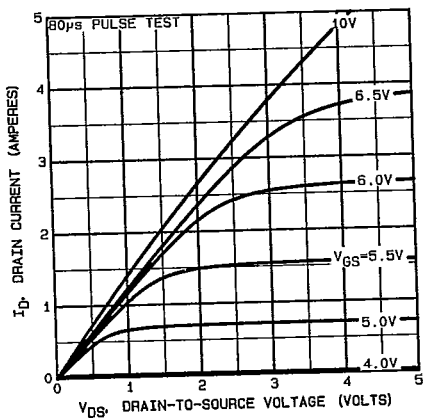

Fig. 3 — Typical Saturation Characteristics

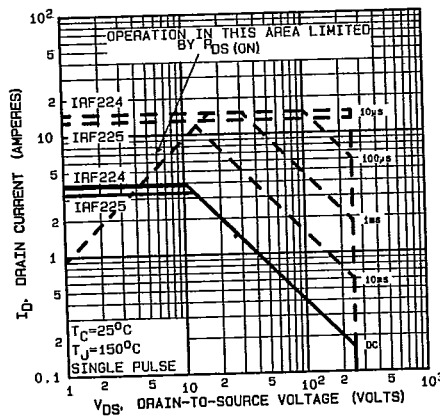

Fig. 4 — Maximum Safe Operating Area

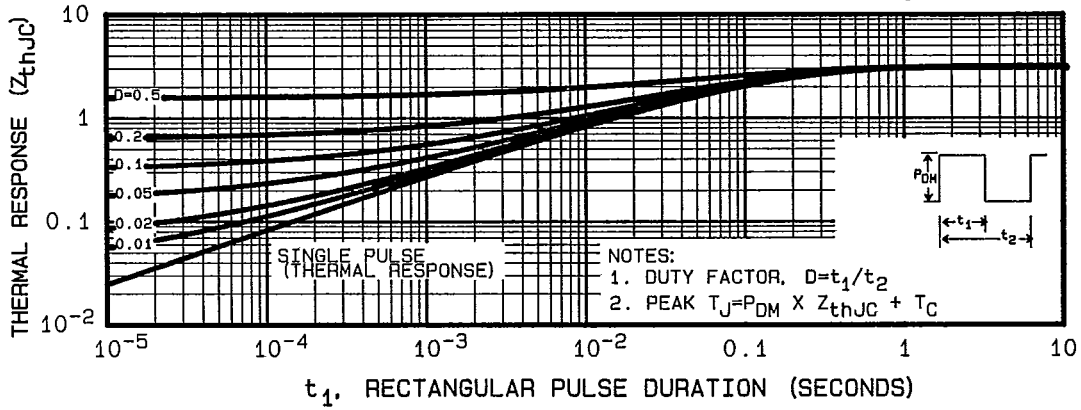

Fig. 5 — Maximum Effective Transient Thermal Impedance, Junction-to-Case Vs. Pulse Duration

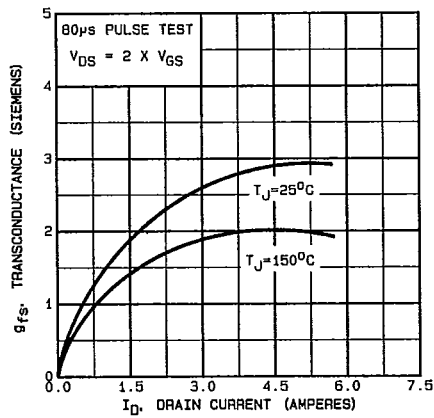

Fig. 6 — Typical Transconductance Vs. Drain Current

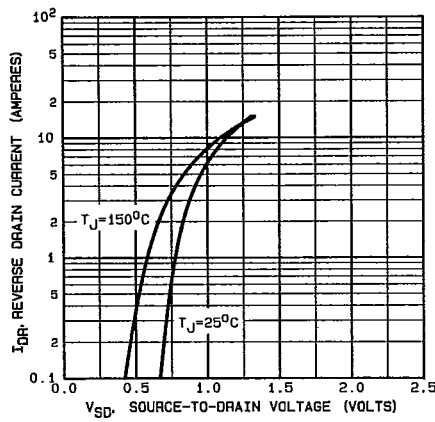

Fig. 7 — Typical Source-Drain Diode Forward Voltage

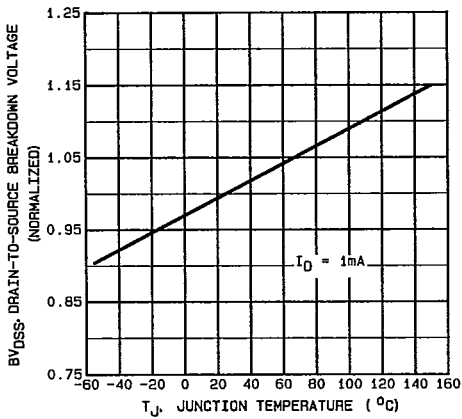

Fig. 8 — Breakdown Voltage Vs. Temperature

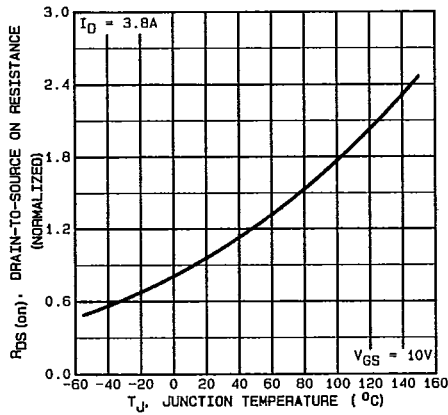

Fig. 9 — Normalized On-Resistance Vs. Temperature

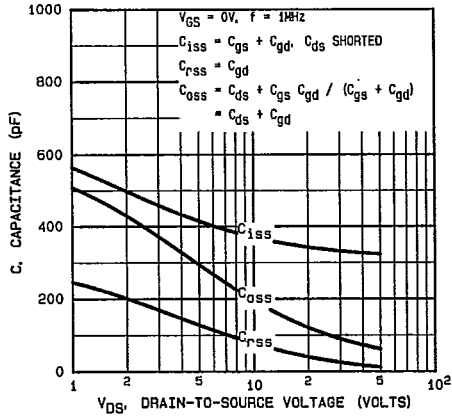

Fig. 10 — Typical Capacitance Vs. Drain-to-Source Voltage

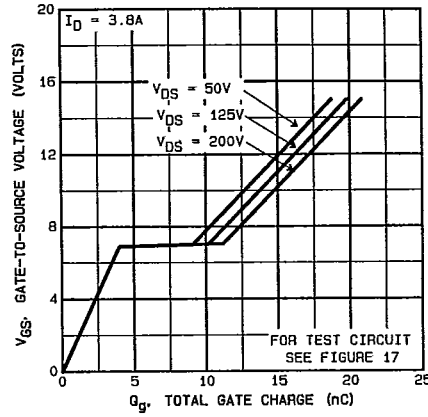

Fig. 11 — Typical Gate Charge Vs. Gate-to-Source Voltage

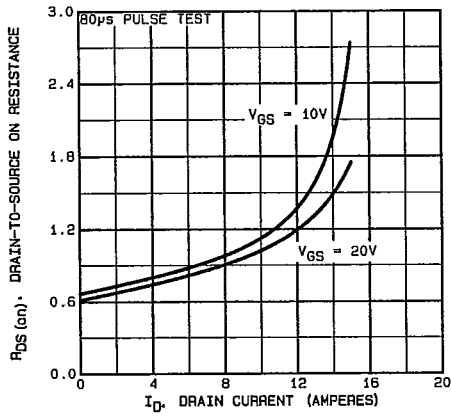

Fig. 12 — Typical On-Resistance Vs. Drain Current

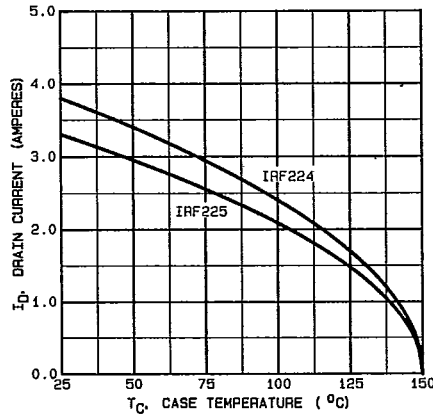

Fig. 13 — Maximum Drain Current Vs. Case Temperature

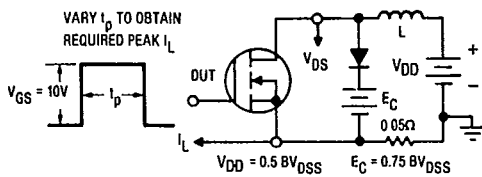

Fig. 14a — Clamped Inductive Test Circuit

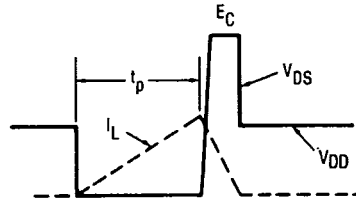

Fig. 14b — Clamped Inductive Waveforms



IRF224, IRF225 Devices

INTERNATIONAL RECTIFIER

T-39-11

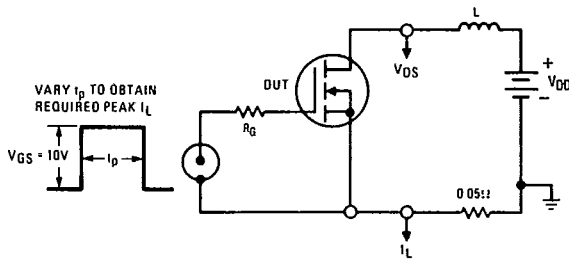

Fig. 15a — Unclamped Inductive Test Circuit

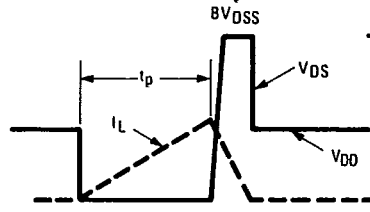

Fig. 15b — Unclamped Inductive Load Test Waveforms

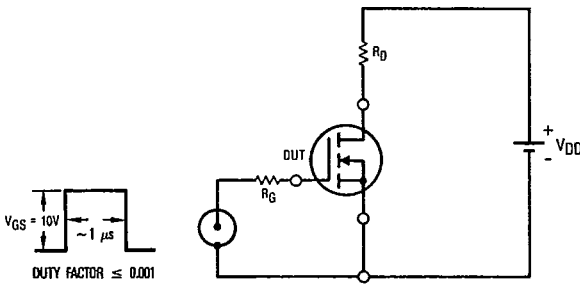

Fig. 16 — Switching Time Test Circuit

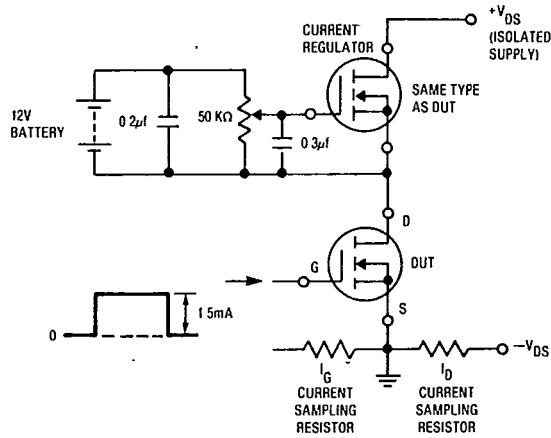
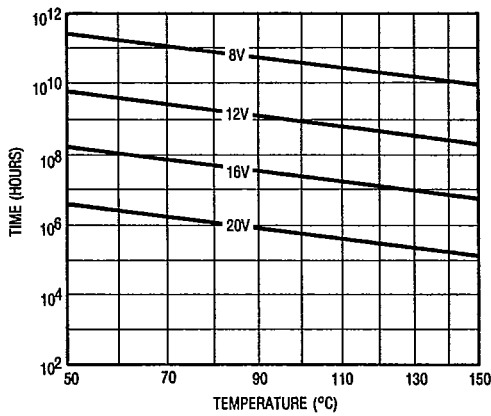
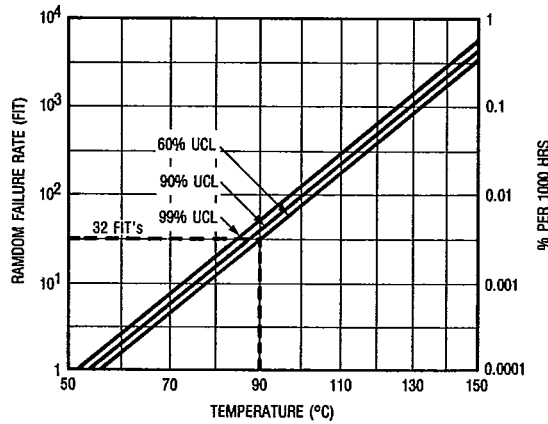

Fig. 17 — Gate Charge Test Circuit



*Fig. 18 — Typical Time to Accumulated 1% Gate Failure



*Fig. 19 — Typical High Temperature Reverse Bias (HTRB) Failure Rate

*The data shown is correct as of April 15, 1987. This information is updated on a quarterly basis; for the latest reliability data, please contact your local IR field office.