

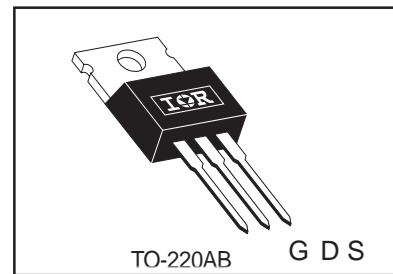
**Applications**

- Switch Mode Power Supply ( SMPS )
- Uninterruptable Power Supply
- High speed power switching

$V_{DSS}$	$R_{ds(on) \max}$	$I_D$
600V	1.2Ω	6.2A

**Benefits**

- Low Gate Charge  $Q_g$  results in Simple Drive Requirement
- Improved Gate, Avalanche and Dynamic  $dv/dt$  Ruggedness
- Fully Characterized Capacitance and Avalanche Voltage and Current
- Effective  $C_{oss}$  Specified ( See AN 1001)



**Absolute Maximum Ratings**

	Parameter	Max.	Units
$I_D @ T_C = 25^\circ\text{C}$	Continuous Drain Current, $V_{GS} @ 10\text{V}$	6.2	A
$I_D @ T_C = 100^\circ\text{C}$	Continuous Drain Current, $V_{GS} @ 10\text{V}$	3.9	
$I_{DM}$	Pulsed Drain Current ①	25	
$P_D @ T_C = 25^\circ\text{C}$	Power Dissipation	125	W
	Linear Derating Factor	1.0	W/°C
$V_{GS}$	Gate-to-Source Voltage	± 30	V
$dv/dt$	Peak Diode Recovery $dv/dt$ ③	6.0	V/ns
$T_J$	Operating Junction and	-55 to + 150	°C
$T_{STG}$	Storage Temperature Range		
	Soldering Temperature, for 10 seconds		
	Mounting torque, 6-32 or M3 screw	10 lbf•in (1.1N•m)	

**Typical SMPS Topologies:**

- Single Transistor Forward

Notes ① through ⑤ are on page 8

www.irf.com

# IRFBC40A

Static @  $T_J = 25^\circ\text{C}$  (unless otherwise specified)

International  
IR Rectifier

	Parameter	Min.	Typ.	Max.	Units	Conditions
$V_{(BR)DSS}$	Drain-to-Source Breakdown Voltage	600	—	—	V	$V_{GS} = 0V, I_D = 250\mu A$
$\Delta V_{(BR)DSS}/\Delta T_J$	Breakdown Voltage Temp. Coefficient	—	0.66	—	V/°C	Reference to $25^\circ\text{C}, I_D = 1\text{mA}$ ⑥
$R_{DS(on)}$	Static Drain-to-Source On-Resistance	—	—	1.2	$\Omega$	$V_{GS} = 10V, I_D = 3.7A$ ④
$V_{GS(th)}$	Gate Threshold Voltage	2.0	—	4.0	V	$V_{DS} = V_{GS}, I_D = 250\mu A$
$I_{DSS}$	Drain-to-Source Leakage Current	—	—	25	$\mu A$	$V_{DS} = 600V, V_{GS} = 0V$
		—	—	250		$V_{DS} = 480V, V_{GS} = 0V, T_J = 125^\circ\text{C}$
$I_{GSS}$	Gate-to-Source Forward Leakage	—	—	100	nA	$V_{GS} = 30V$
	Gate-to-Source Reverse Leakage	—	—	-100		$V_{GS} = -30V$

Dynamic @  $T_J = 25^\circ\text{C}$  (unless otherwise specified)

	Parameter	Min.	Typ.	Max.	Units	Conditions
$g_{fs}$	Forward Transconductance	3.4	—	—	S	$V_{DS} = 50V, I_D = 3.7A$
$Q_g$	Total Gate Charge	—	—	42	nC	$I_D = 6.2A$ $V_{DS} = 480V$ $V_{GS} = 10V$ , See Fig. 6 and 13 ④
$Q_{gs}$	Gate-to-Source Charge	—	—	10		
$Q_{gd}$	Gate-to-Drain ("Miller") Charge	—	—	20		
$t_{d(on)}$	Turn-On Delay Time	—	13	—	ns	$V_{DD} = 300V$ $I_D = 6.2A$ $R_G = 9.1\Omega$ $R_D = 47\Omega$ , See Fig. 10 ④
$t_r$	Rise Time	—	23	—		
$t_{d(off)}$	Turn-Off Delay Time	—	31	—		
$t_f$	Fall Time	—	18	—		
$C_{iss}$	Input Capacitance	—	1036	—	pF	$V_{GS} = 0V$ $V_{DS} = 25V$ $f = 1.0\text{MHz}$ , See Fig. 5
$C_{oss}$	Output Capacitance	—	136	—		
$C_{riss}$	Reverse Transfer Capacitance	—	7.0	—		
$C_{oss}$	Output Capacitance	—	1487	—		
$C_{oss}$	Output Capacitance	—	36	—		
$C_{oss\ eff.}$	Effective Output Capacitance	—	48	—		

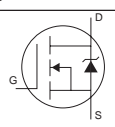
## Avalanche Characteristics

	Parameter	Typ.	Max.	Units
$E_{AS}$	Single Pulse Avalanche Energy②	—	570	mJ
$I_{AR}$	Avalanche Current①	—	6.2	A
$E_{AR}$	Repetitive Avalanche Energy①	—	13	mJ

## Thermal Resistance

	Parameter	Typ.	Max.	Units
$R_{\theta JC}$	Junction-to-Case	—	1.0	°C/W
$R_{\theta CS}$	Case-to-Sink, Flat, Greased Surface	0.50	—	
$R_{\theta JA}$	Junction-to-Ambient	—	62	

## Diode Characteristics

	Parameter	Min.	Typ.	Max.	Units	Conditions
$I_S$	Continuous Source Current (Body Diode)	—	—	6.2	A	MOSFET symbol showing the integral reverse p-n junction diode. 
$I_{SM}$	Pulsed Source Current (Body Diode) ①	—	—	25		
$V_{SD}$	Diode Forward Voltage	—	—	1.5	V	$T_J = 25^\circ\text{C}, I_S = 6.2A, V_{GS} = 0V$ ④
$t_{rr}$	Reverse Recovery Time	—	431	647	ns	$T_J = 25^\circ\text{C}, I_F = 6.2A$
$Q_{rr}$	Reverse Recovery Charge	—	1.8	2.8	$\mu C$	$di/dt = 100A/\mu s$ ④
$t_{on}$	Forward Turn-On Time	Intrinsic turn-on time is negligible (turn-on is dominated by $L_S + L_D$ )				

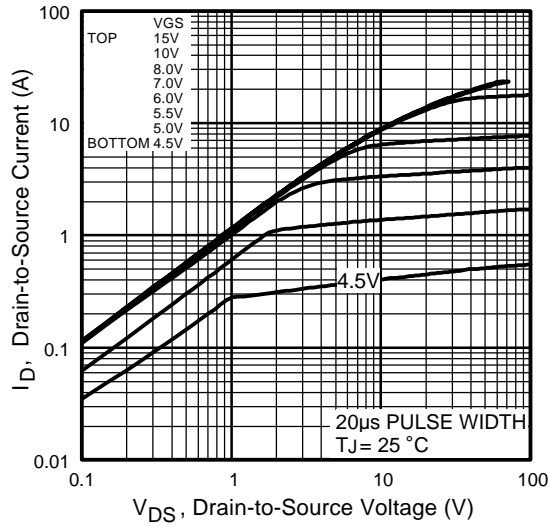


Fig 1. Typical Output Characteristics,

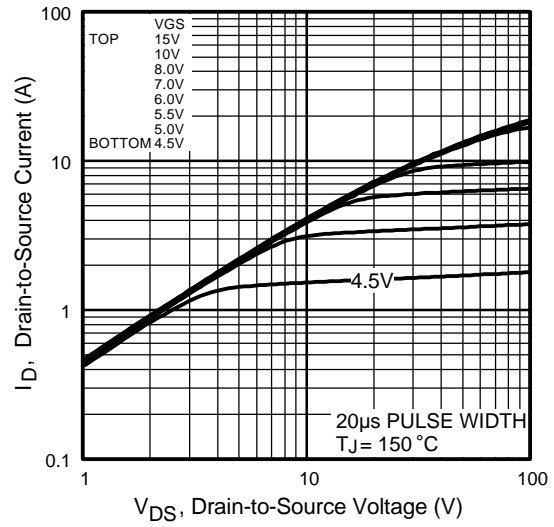


Fig 2. Typical Output Characteristics,

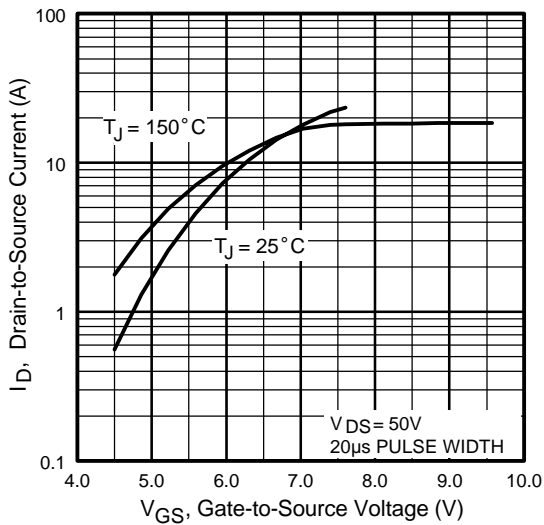


Fig 3. Typical Transfer Characteristics

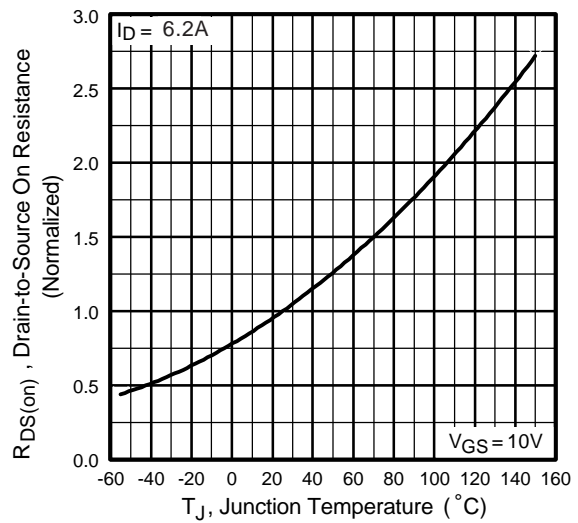
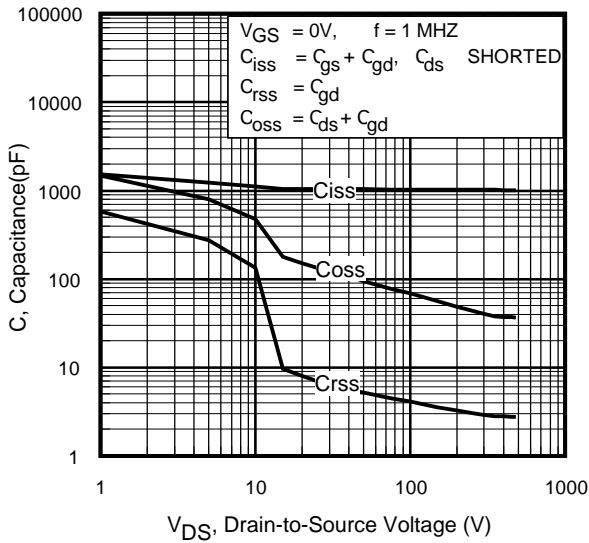
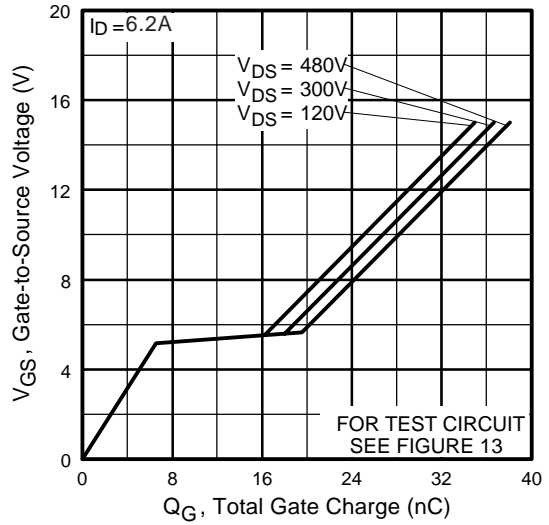


Fig 4. Normalized On-Resistance Vs. Temperature

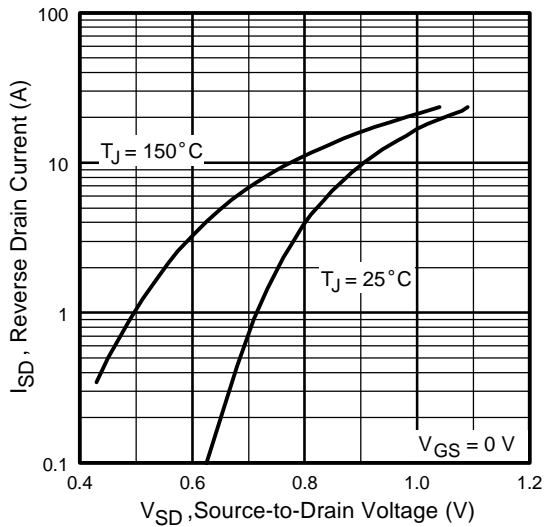
# IRFBC40A



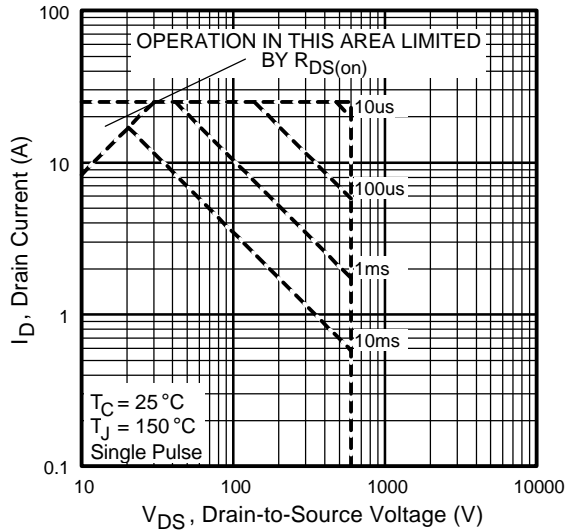
**Fig 5.** Typical Capacitance Vs. Drain-to-Source Voltage



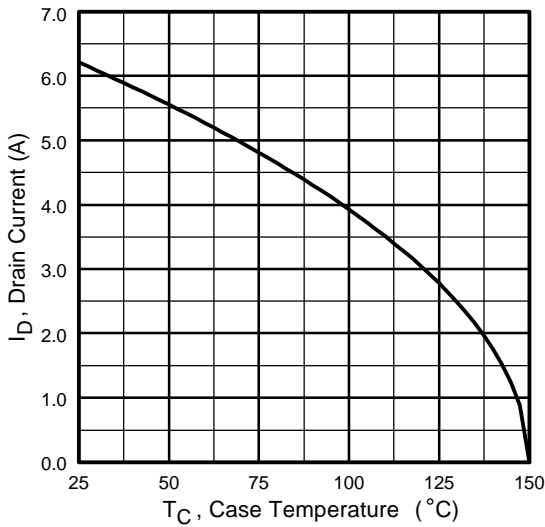
**Fig 6.** Typical Gate Charge Vs. Gate-to-Source Voltage



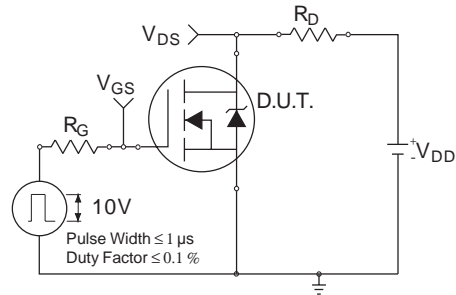
**Fig 7.** Typical Source-Drain Diode Forward Voltage



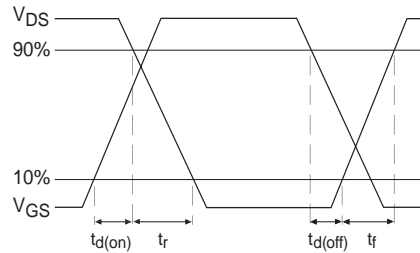
**Fig 8.** Maximum Safe Operating Area



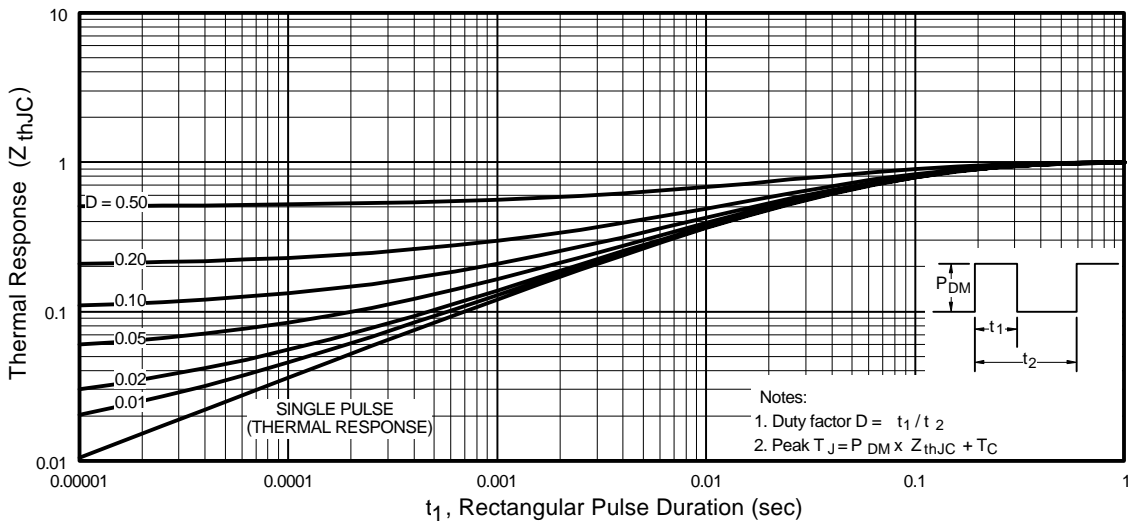
**Fig 9.** Maximum Drain Current Vs. Case Temperature



**Fig 10a.** Switching Time Test Circuit

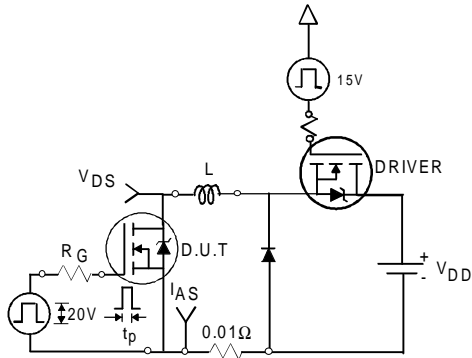


**Fig 10b.** Switching Time Waveforms

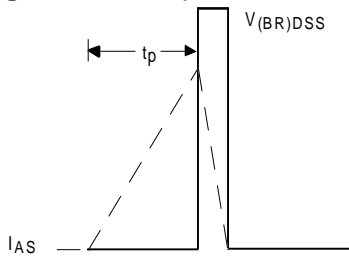


**Fig 11.** Maximum Effective Transient Thermal Impedance, Junction-to-Case

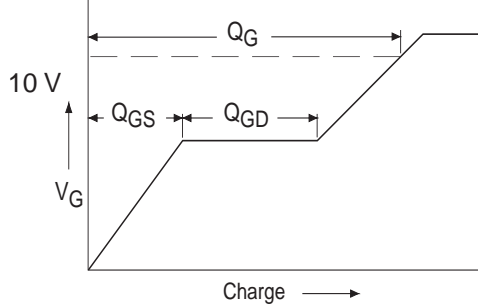
# IRFBC40A



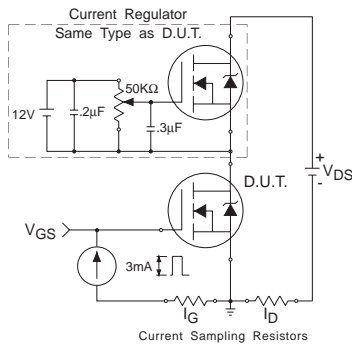
**Fig 12a.** Unclamped Inductive Test Circuit



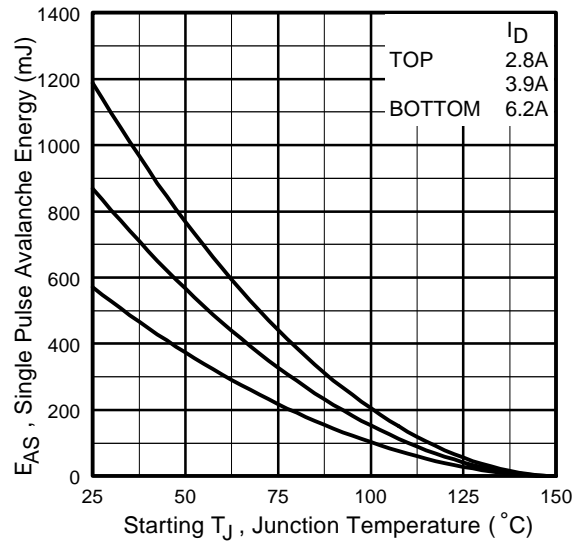
**Fig 12b.** Unclamped Inductive Waveforms



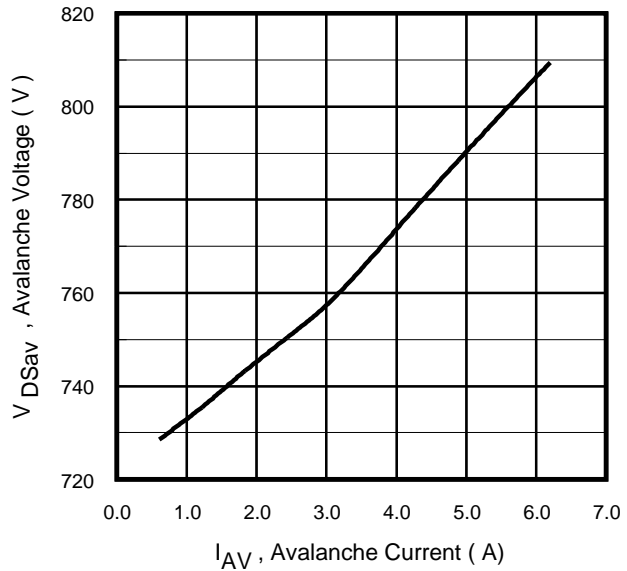
**Fig 13a.** Basic Gate Charge Waveform



**Fig 13b.** Gate Charge Test Circuit

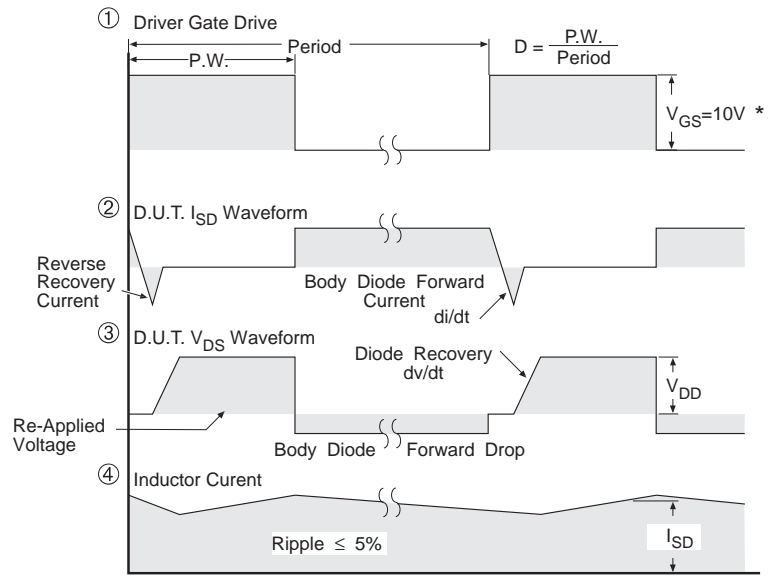
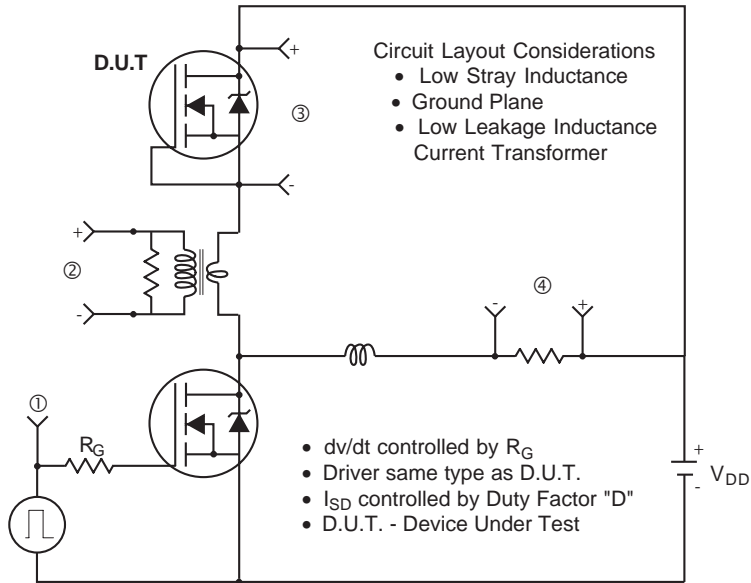


**Fig 12c.** Maximum Avalanche Energy Vs. Drain Current



**Fig 12d.** Typical Drain-to-Source Voltage Vs. Avalanche Current

**Peak Diode Recovery dv/dt Test Circuit**



\*  $V_{GS} = 5V$  for Logic Level Devices

**Fig 14.** For N-Channel HEXFETS

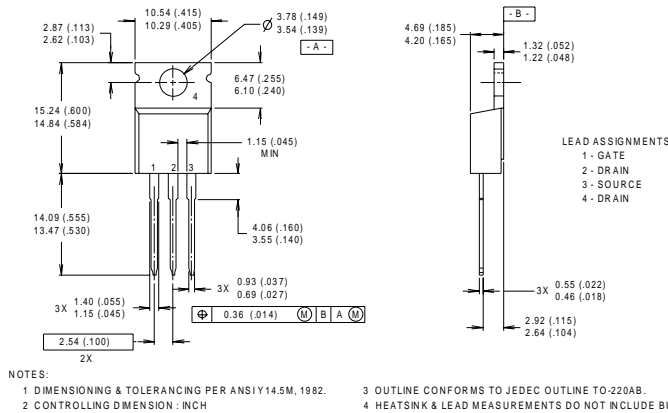
# IRFBC40A



## Package Outline

### TO-220AB Outline

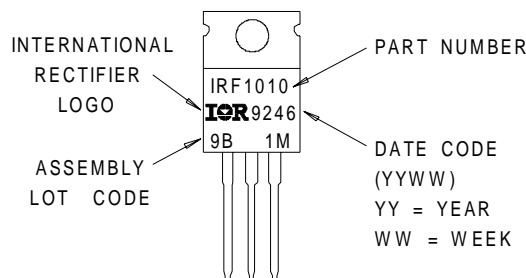
Dimensions are shown in millimeters (inches)



## Part Marking Information

### TO-220AB

EXAMPLE : THIS IS AN IRF1010  
 WITH ASSEMBLY  
 LOT CODE 9B1M



#### Notes:

- ① Repetitive rating; pulse width limited by max. junction temperature. ( See fig. 11 )
- ② Starting  $T_J = 25^\circ\text{C}$ ,  $L = 29.6\text{mH}$   
 $R_G = 25\Omega$ ,  $I_{AS} = 6.2\text{A}$ . (See Figure 12)
- ③  $I_{SD} \leq 6.2\text{A}$ ,  $di/dt \leq 80\text{A}/\mu\text{s}$ ,  $V_{DD} \leq V_{(BR)DSS}$ ,  
 $T_J \leq 150^\circ\text{C}$
- ④ Pulse width  $\leq 300\mu\text{s}$ ; duty cycle  $\leq 2\%$ .
- ⑤  $C_{OSS}$  eff. is a fixed capacitance that gives the same charging time as  $C_{OSS}$  while  $V_{DS}$  is rising from 0 to 80%  $V_{DSS}$



**WORLD HEADQUARTERS:** 233 Kansas St., El Segundo, California 90245, Tel: (310) 322 3331  
**IR GREAT BRITAIN:** Hurst Green, Oxted, Surrey RH8 9BB, UK Tel: ++ 44 1883 732020  
**IR CANADA:** 15 Lincoln Court, Brampton, Ontario L6T3Z2, Tel: (905) 453 2200  
**IR GERMANY:** Saalburgstrasse 157, 61350 Bad Homburg Tel: ++ 49 6172 96590  
**IR ITALY:** Via Liguria 49, 10071 Borgaro, Torino Tel: ++ 39 11 451 0111  
**IR FAR EAST:** K&H Bldg., 2F, 30-4 Nishi-Ikebukuro 3-Chome, Toshima-Ku, Tokyo Japan 171 Tel: 81 3 3983 0086  
**IR SOUTHEAST ASIA:** 1 Kim Seng Promenade, Great World City West Tower, 13-11, Singapore 237994 Tel: ++ 65 838 4630  
**IR TAIWAN:** 16 Fl. Suite D. 207, Sec. 2, Tun Haw South Road, Taipei, 10673, Taiwan Tel: 886-2-2377-9936  
<http://www.irf.com/> Data and specifications subject to change without notice. 6/99