

IRFP4710

HEXFET® Power MOSFET

Applications

- High frequency DC-DC converters
- Motor Control
- Uninterruptible Power Supplies

V_{DSS}	R_{DS(on)} max	I_D
100V	0.014Ω	72A

Benefits

- Low Gate-to-Drain Charge to Reduce Switching Losses
- Fully Characterized Capacitance Including Effective C_{OSS} to Simplify Design, (See App. Note AN1001)
- Fully Characterized Avalanche Voltage and Current

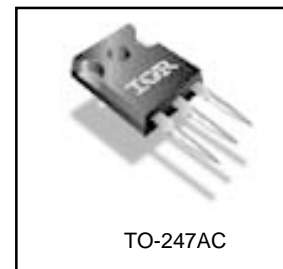

Absolute Maximum Ratings

	Parameter	Max.	Units
I _D @ T _C = 25°C	Continuous Drain Current, V _{GS} @ 10V	72	A
I _D @ T _C = 100°C	Continuous Drain Current, V _{GS} @ 10V	51	
I _{DM}	Pulsed Drain Current ①	300	
P _D @ T _C = 25°C	Power Dissipation	190	W
	Linear Derating Factor	1.2	W/°C
V _{GS}	Gate-to-Source Voltage	± 20	V
dv/dt	Peak Diode Recovery dv/dt ③	8.2	V/ns
T _J	Operating Junction and	-55 to + 175	°C
T _{STG}	Storage Temperature Range		
	Soldering Temperature, for 10 seconds		
	Mounting torque, 6-32 or M3 screw	10 lbf•in (1.1N•m)	

Thermal Resistance

	Parameter	Typ.	Max.	Units
R _{θJC}	Junction-to-Case	—	0.81	°C/W
R _{θCS}	Case-to-Sink, Flat, Greased Surface	0.24	—	
R _{θJA}	Junction-to-Ambient	—	40	

Notes ① through ⑤ are on page 8

www.irf.com

Static @ T_J = 25°C (unless otherwise specified)

	Parameter	Min.	Typ.	Max.	Units	Conditions
V _{(BR)DSS}	Drain-to-Source Breakdown Voltage	100	—	—	V	V _{GS} = 0V, I _D = 250μA
ΔV _{(BR)DSS} /ΔT _J	Breakdown Voltage Temp. Coefficient	—	0.11	—	V/°C	Reference to 25°C, I _D = 1mA
R _{DS(on)}	Static Drain-to-Source On-Resistance	—	0.011	0.014	Ω	V _{GS} = 10V, I _D = 45A ④
V _{GS(th)}	Gate Threshold Voltage	3.5	—	5.5	V	V _{DS} = V _{GS} , I _D = 250μA
I _{DSS}	Drain-to-Source Leakage Current	—	—	1.0	μA	V _{DS} = 95V, V _{GS} = 0V
		—	—	250		V _{DS} = 80V, V _{GS} = 0V, T _J = 150°C
I _{GSS}	Gate-to-Source Forward Leakage	—	—	100	nA	V _{GS} = 20V
	Gate-to-Source Reverse Leakage	—	—	-100		V _{GS} = -20V

Dynamic @ T_J = 25°C (unless otherwise specified)

	Parameter	Min.	Typ.	Max.	Units	Conditions
g _{fs}	Forward Transconductance	35	—	—	S	V _{DS} = 50V, I _D = 45A
Q _g	Total Gate Charge	—	110	170	nC	I _D = 45A
Q _{gs}	Gate-to-Source Charge	—	43	—		V _{DS} = 50V
Q _{gd}	Gate-to-Drain ("Miller") Charge	—	40	—		V _{GS} = 10V,
t _{d(on)}	Turn-On Delay Time	—	35	—	ns	V _{DD} = 50V
t _r	Rise Time	—	130	—		I _D = 45A
t _{d(off)}	Turn-Off Delay Time	—	41	—		R _G = 4.5Ω
t _f	Fall Time	—	38	—		V _{GS} = 10V ④
C _{iss}	Input Capacitance	—	6160	—	pF	V _{GS} = 0V
C _{oss}	Output Capacitance	—	440	—		V _{DS} = 25V
C _{riss}	Reverse Transfer Capacitance	—	250	—		f = 1.0MHz
C _{oss}	Output Capacitance	—	1580	—		V _{GS} = 0V, V _{DS} = 1.0V, f = 1.0MHz
C _{oss}	Output Capacitance	—	280	—		V _{GS} = 0V, V _{DS} = 80V, f = 1.0MHz
C _{oss eff.}	Effective Output Capacitance	—	430	—		V _{GS} = 0V, V _{DS} = 0V to 80V ⑤

Avalanche Characteristics

	Parameter	Typ.	Max.	Units
E _{AS}	Single Pulse Avalanche Energy②	—	190	mJ
I _{AR}	Avalanche Current①	—	45	A
E _{AR}	Repetitive Avalanche Energy①	—	20	mJ

Diode Characteristics

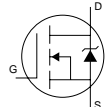
	Parameter	Min.	Typ.	Max.	Units	Conditions
I _S	Continuous Source Current (Body Diode)	—	—	72	A	MOSFET symbol showing the integral reverse p-n junction diode. 
I _{SM}	Pulsed Source Current (Body Diode) ①	—	—	300		
V _{SD}	Diode Forward Voltage	—	—	1.3	V	T _J = 25°C, I _S = 45A, V _{GS} = 0V ④
t _{rr}	Reverse Recovery Time	—	74	110	ns	T _J = 25°C, I _F = 45A
Q _{rr}	Reverse Recovery Charge	—	180	260	nC	di/dt = 100A/μs ④
t _{on}	Forward Turn-On Time	Intrinsic turn-on time is negligible (turn-on is dominated by L _S +L _D)				

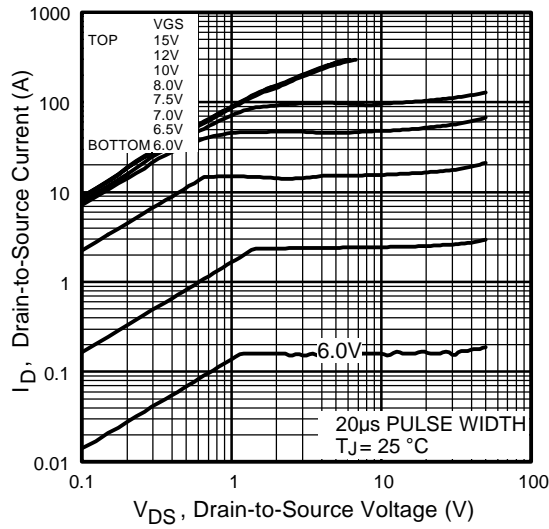

Fig 1. Typical Output Characteristics

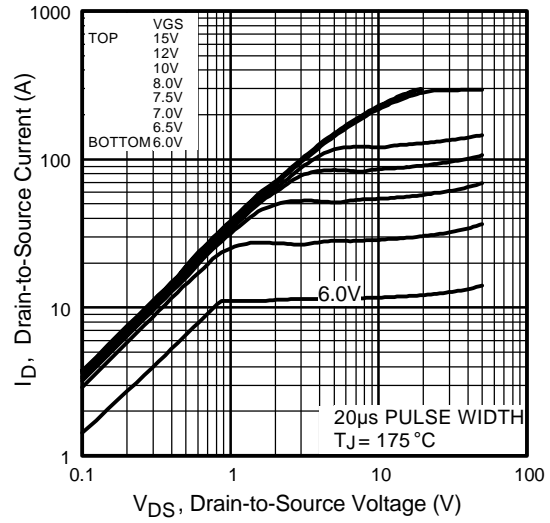

Fig 2. Typical Output Characteristics

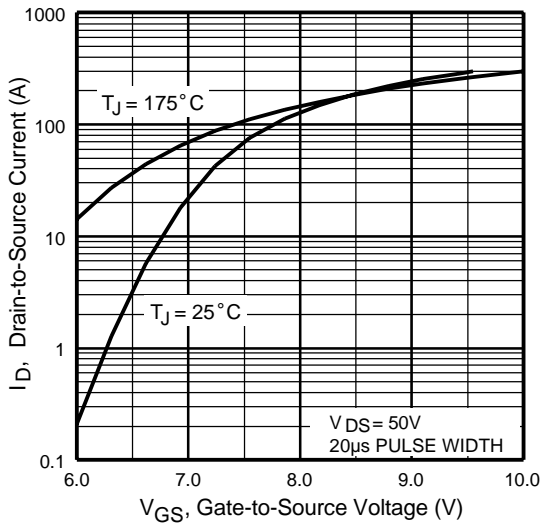

Fig 3. Typical Transfer Characteristics

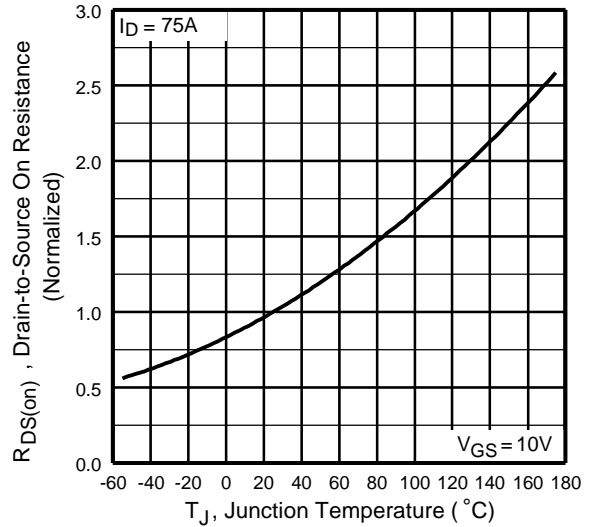

Fig 4. Normalized On-Resistance Vs. Temperature

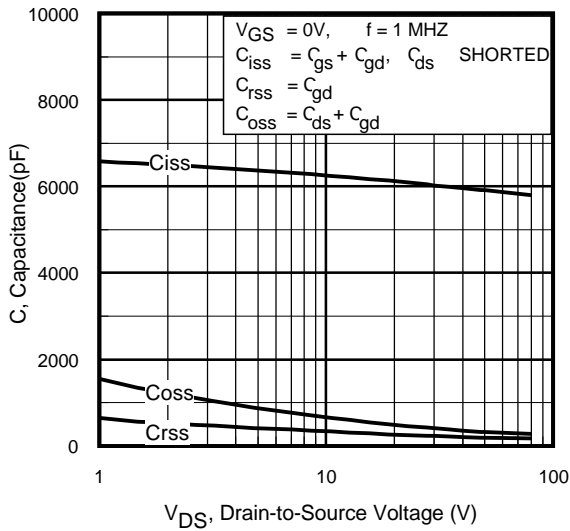

Fig 5. Typical Capacitance Vs. Drain-to-Source Voltage

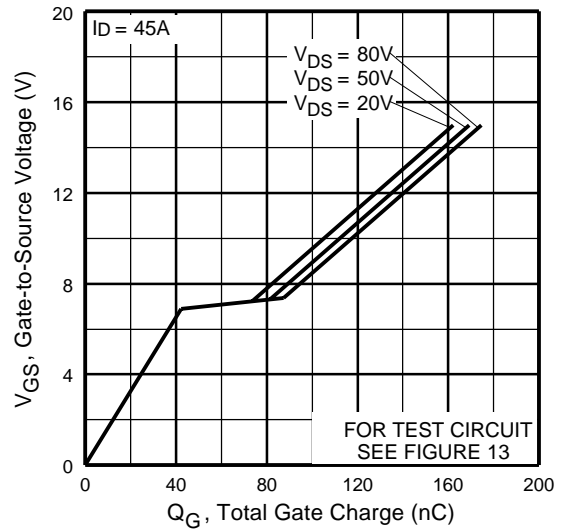

Fig 6. Typical Gate Charge Vs. Gate-to-Source Voltage

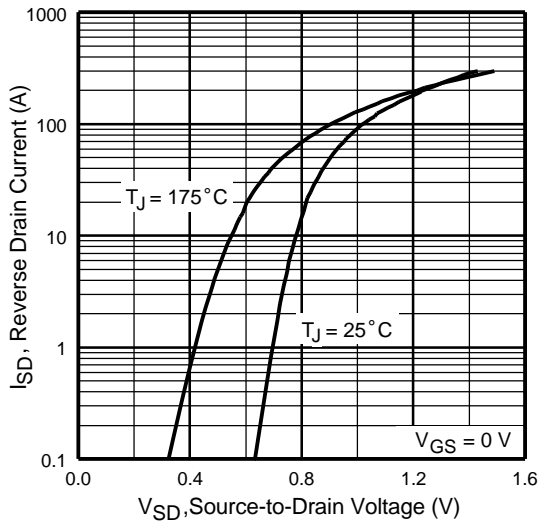

Fig 7. Typical Source-Drain Diode Forward Voltage

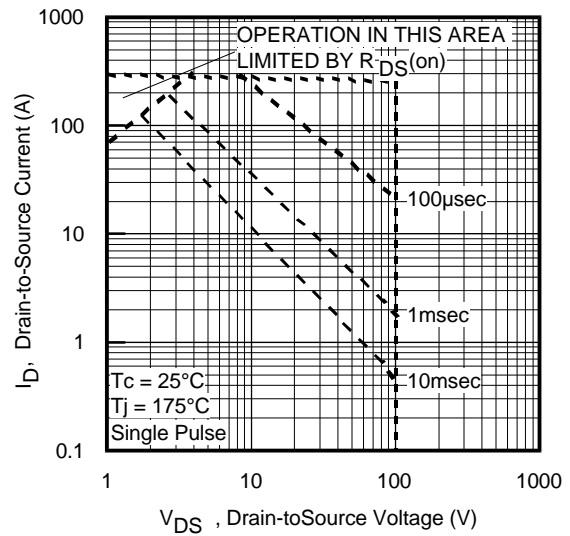

Fig 8. Maximum Safe Operating Area

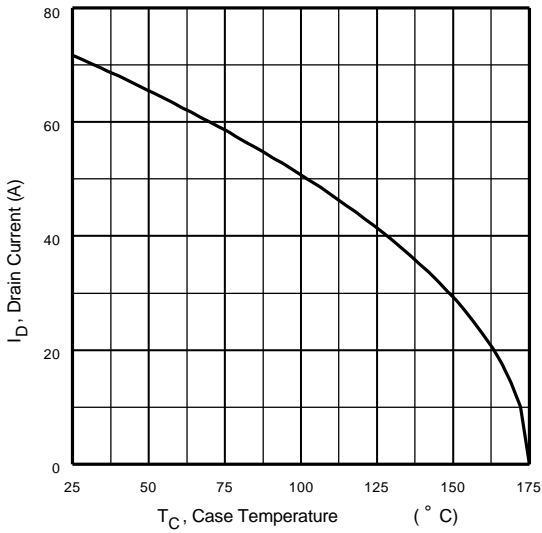

Fig 9. Maximum Drain Current Vs. Case Temperature



Fig 10a. Switching Time Test Circuit



Fig 10b. Switching Time Waveforms

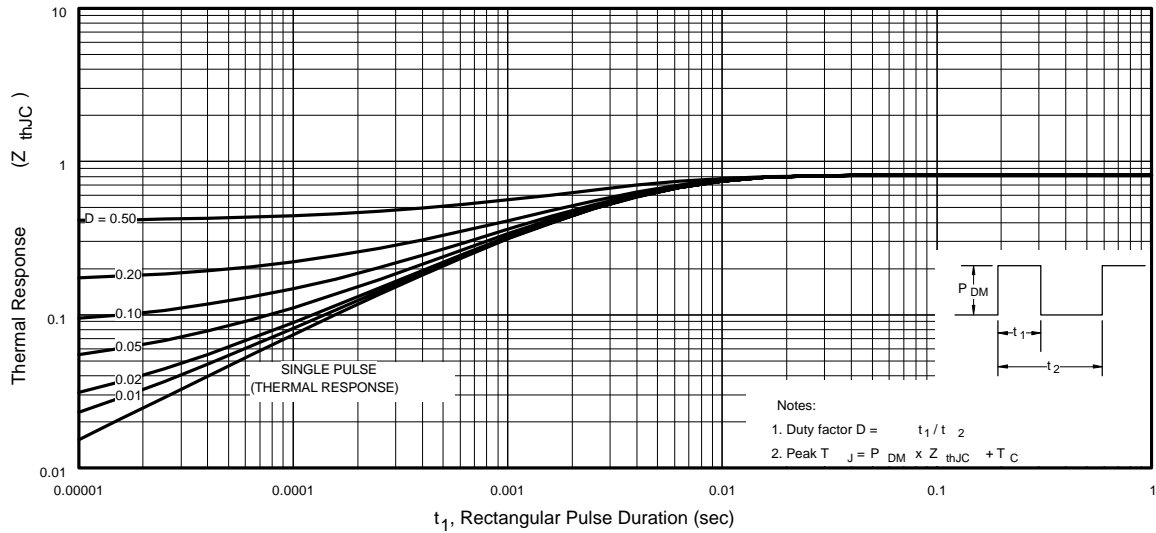

Fig 11. Maximum Effective Transient Thermal Impedance, Junction-to-Case

IRFP4710

International
IR Rectifier

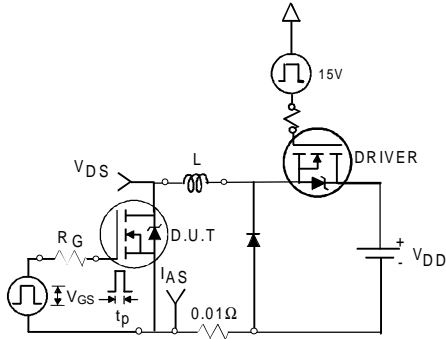

Fig 12a. Unclamped Inductive Test Circuit



Fig 12b. Unclamped Inductive Waveforms

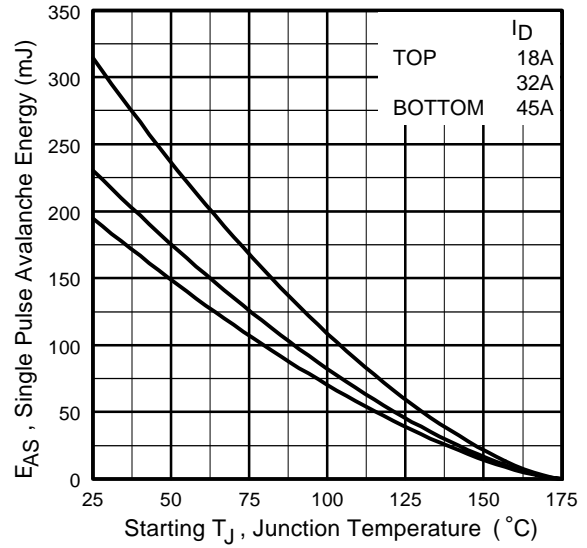

Fig 12c. Maximum Avalanche Energy Vs. Drain Current

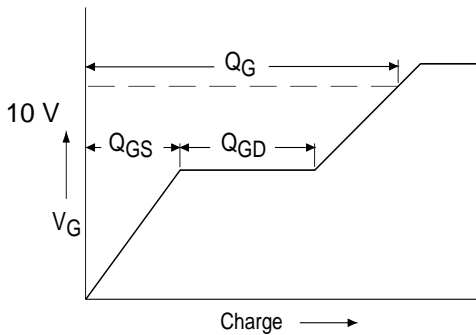

Fig 13a. Basic Gate Charge Waveform

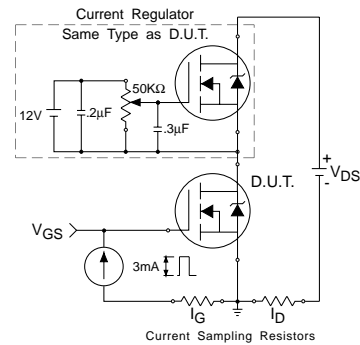
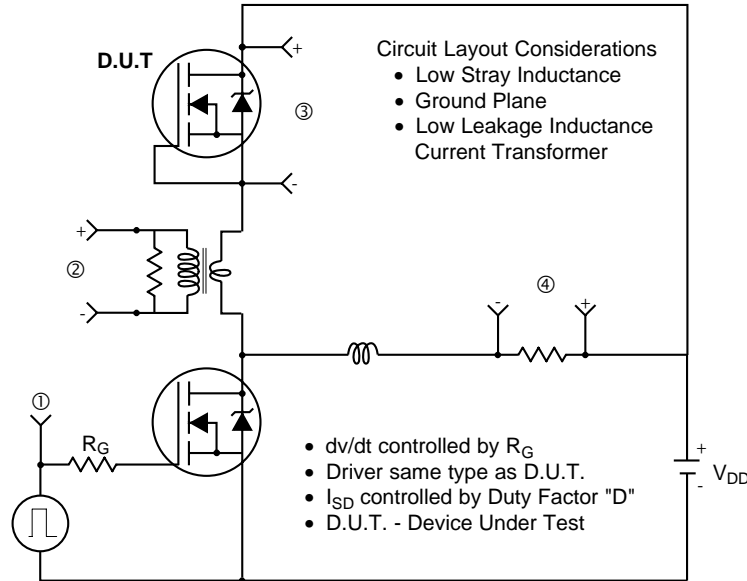

Fig 13b. Gate Charge Test Circuit

Peak Diode Recovery dv/dt Test Circuit



* $V_{GS} = 5V$ for Logic Level Devices

Fig 14. For N-Channel HEXFET® Power MOSFETs

IRFP4710

International
IR Rectifier

TO-247AC Package Outline

Dimensions are shown in millimeters (inches)

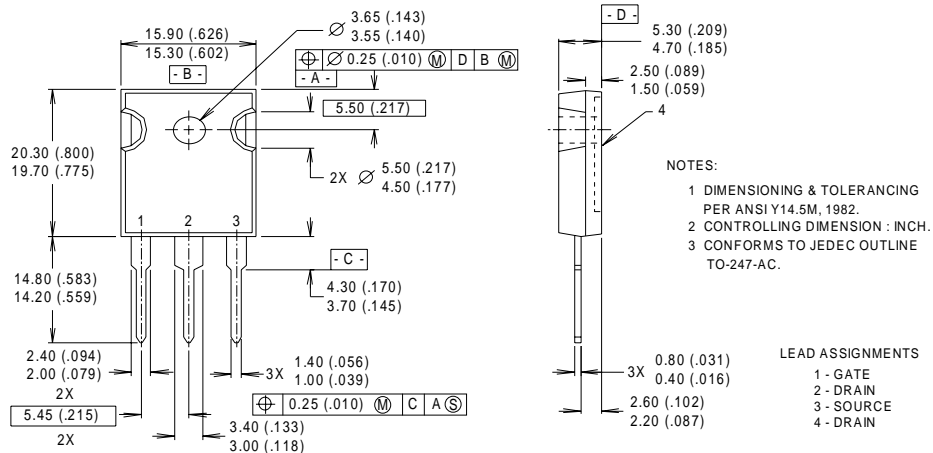

TO-247AC Part Marking Information

EXAMPLE: THIS IS AN IRFPE30
WTH ASSEMBLY
LOT CODE 5657
ASSEMBLED ON WW 35, 2000
IN THE ASSEMBLY LINE "H"

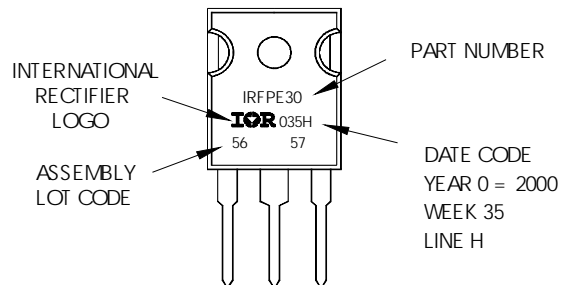

Notes:

- ① Repetitive rating; pulse width limited by max. junction temperature.
- ② Starting $T_J = 25^\circ\text{C}$, $L = 190\mu\text{H}$
 $R_G = 25\Omega$, $I_{AS} = 45\text{A}$, $V_{GS} = 10\text{V}$.
- ③ $I_{SD} \leq 45\text{A}$, $di/dt \leq 420\text{A}/\mu\text{s}$, $V_{DD} \leq V_{(BR)DSS}$,
 $T_J \leq 175^\circ\text{C}$.
- ④ Pulse width $\leq 400\mu\text{s}$; duty cycle $\leq 2\%$.
- ⑤ C_{OSS} eff. is a fixed capacitance that gives the same charging time as C_{OSS} while V_{DS} is rising from 0 to 80% V_{DSS} .

Data and specifications subject to change without notice.
This product has been designed and qualified for the Industrial market.
Qualification Standards can be found on IR's Web site.

International
IR Rectifier

IR WORLD HEADQUARTERS: 233 Kansas St., El Segundo, California 90245, USA Tel: (310) 252-7105
TAC Fax: (310) 252-7903

Visit us at www.irf.com for sales contact information. 01/02

www.irf.com