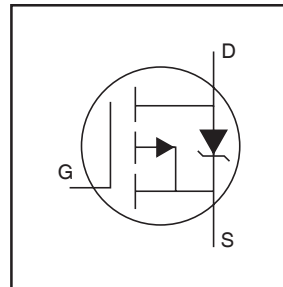


# IRLML6302PbF

HEXFET<sup>®</sup> Power MOSFET

- Generation V Technology
- Ultra Low On-Resistance
- P-Channel MOSFET
- SOT-23 Footprint
- Low Profile (<1.1mm)
- Available in Tape and Reel
- Fast Switching
- Lead-Free

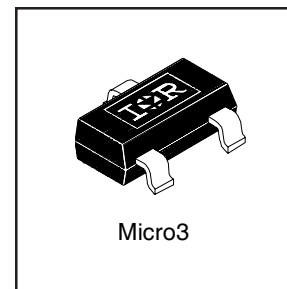


$V_{DSS} = -20V$
$R_{DS(on)} = 0.60\Omega$

## Description

Fifth Generation HEXFETs from International Rectifier utilize advanced processing techniques to achieve extremely low on-resistance per silicon area. This benefit, combined with the fast switching speed and ruggedized device design that HEXFET Power MOSFETs are well known for, provides the designer with an extremely efficient and reliable device for use in a wide variety of applications.

A customized leadframe has been incorporated into the standard SOT-23 package to produce a HEXFET Power MOSFET with the industry's smallest footprint. This package, dubbed the Micro3, is ideal for applications where printed circuit board space is at a premium. The low profile (<1.1mm) of the Micro3 allows it to fit easily into extremely thin application environments such as portable electronics and PCMCIA cards.



## Absolute Maximum Ratings

	Parameter	Max.	Units
$I_D @ T_A = 25^\circ C$	Continuous Drain Current, $V_{GS} @ -4.5V$	-0.78	A
$I_D @ T_A = 70^\circ C$	Continuous Drain Current, $V_{GS} @ -4.5V$	-0.62	
$I_{DM}$	Pulsed Drain Current ①	-4.9	
$P_D @ T_A = 25^\circ C$	Power Dissipation	540	mW
	Linear Derating Factor	4.3	mW/°C
$V_{GS}$	Gate-to-Source Voltage	$\pm 12$	V
dv/dt	Peak Diode Recovery dv/dt ②	-5.0	V/ns
$T_J, T_{STG}$	Junction and Storage Temperature Range	-55 to + 150	°C

## Thermal Resistance

	Parameter	Typ.	Max.	Units
$R_{\theta JA}$	Maximum Junction-to-Ambient ④	—	230	°C/W

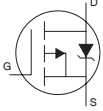
# IRLML6302PbF

International  
**IR** Rectifier

## Electrical Characteristics @ $T_J = 25^\circ\text{C}$ (unless otherwise specified)

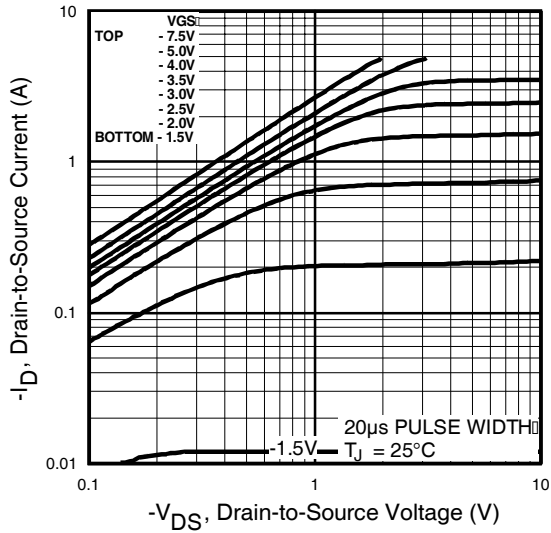
	Parameter	Min.	Typ.	Max.	Units	Conditions
$V_{(BR)DSS}$	Drain-to-Source Breakdown Voltage	-20	---	---	V	$V_{GS} = 0V, I_D = -250\mu A$
$\Delta V_{(BR)DSS}/\Delta T_J$	Breakdown Voltage Temp. Coefficient	---	-4.9	---	mV/ $^\circ\text{C}$	Reference to $25^\circ\text{C}, I_D = -1\text{mA}$
$R_{DS(ON)}$	Static Drain-to-Source On-Resistance	---	---	0.60	$\Omega$	$V_{GS} = -4.5V, I_D = -0.61A$ ③
		---	---	0.90		$V_{GS} = -2.7V, I_D = -0.31A$ ③
$V_{GS(th)}$	Gate Threshold Voltage	-0.70	---	-1.5	V	$V_{DS} = V_{GS}, I_D = -250\mu A$
$g_{fs}$	Forward Transconductance	0.56	---	---	S	$V_{DS} = -10V, I_D = -0.31A$
$I_{DSS}$	Drain-to-Source Leakage Current	---	---	-1.0	$\mu A$	$V_{DS} = -16V, V_{GS} = 0V$
		---	---	-25		$V_{DS} = -16V, V_{GS} = 0V, T_J = 125^\circ\text{C}$
$I_{GSS}$	Gate-to-Source Forward Leakage	---	---	-100	nA	$V_{GS} = -12V$
	Gate-to-Source Reverse Leakage	---	---	100		$V_{GS} = 12V$
$Q_g$	Total Gate Charge	---	2.4	3.6	nC	$I_D = -0.61A$
$Q_{gs}$	Gate-to-Source Charge	---	0.56	0.84		$V_{DS} = -16V$
$Q_{gd}$	Gate-to-Drain ("Miller") Charge	---	1.0	1.5		$V_{GS} = -4.5V$ , See Fig. 6 and 9 ③
$t_{d(on)}$	Turn-On Delay Time	---	13	---	ns	$V_{DD} = -10V$
$t_r$	Rise Time	---	18	---		$I_D = -0.61A$
$t_{d(off)}$	Turn-Off Delay Time	---	22	---		$R_G = 6.2\Omega$
$t_f$	Fall Time	---	22	---		$R_D = 16\Omega$ , See Fig. 10 ③
$C_{iss}$	Input Capacitance	---	97	---	pF	$V_{GS} = 0V$
$C_{oss}$	Output Capacitance	---	53	---		$V_{DS} = -15V$
$C_{rss}$	Reverse Transfer Capacitance	---	28	---		$f = 1.0\text{MHz}$ , See Fig. 5

## Source-Drain Ratings and Characteristics

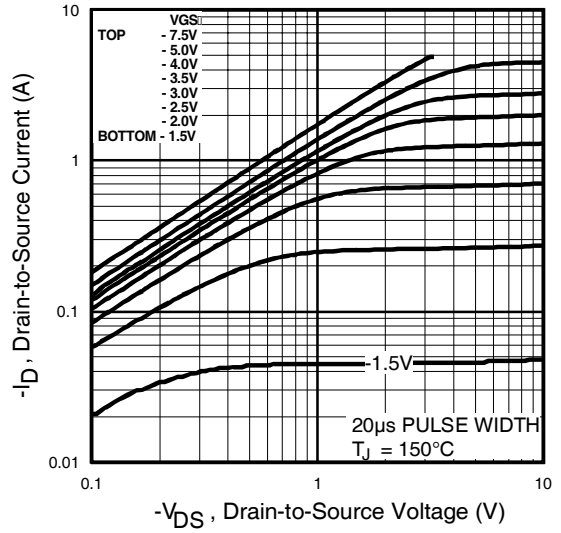
	Parameter	Min.	Typ.	Max.	Units	Conditions
$I_S$	Continuous Source Current (Body Diode)	---	---	-0.54	A	MOSFET symbol showing the integral reverse p-n junction diode. 
$I_{SM}$	Pulsed Source Current (Body Diode) ①	---	---	-4.9		
$V_{SD}$	Diode Forward Voltage	---	---	-1.2	V	$T_J = 25^\circ\text{C}, I_S = -0.61A, V_{GS} = 0V$ ③
$t_{rr}$	Reverse Recovery Time	---	35	53	ns	$T_J = 25^\circ\text{C}, I_F = -0.61A$
$Q_{rr}$	Reverse Recovery Charge	---	26	39	nC	$di/dt = 100A/\mu s$ ③

### Notes:

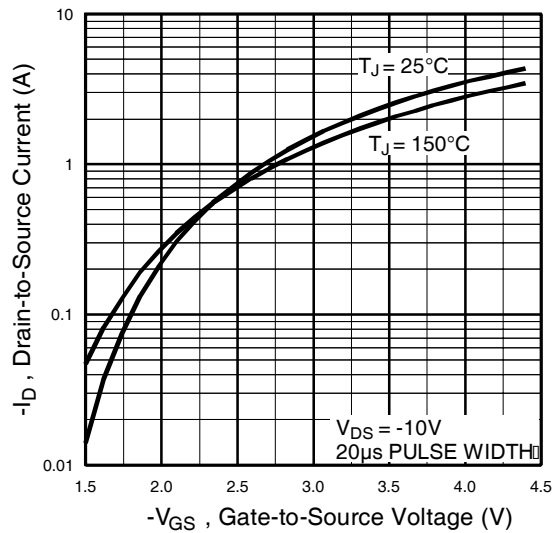
- ① Repetitive rating; pulse width limited by max. junction temperature. ( See fig. 11 )
- ②  $I_{SD} \leq -0.61A, di/dt \leq 76A/\mu s, V_{DD} \leq V_{(BR)DSS}, T_J \leq 150^\circ\text{C}$
- ③ Pulse width  $\leq 300\mu s$ ; duty cycle  $\leq 2\%$ .
- ④ Surface mounted on FR-4 board,  $t \leq 5\text{sec}$ .



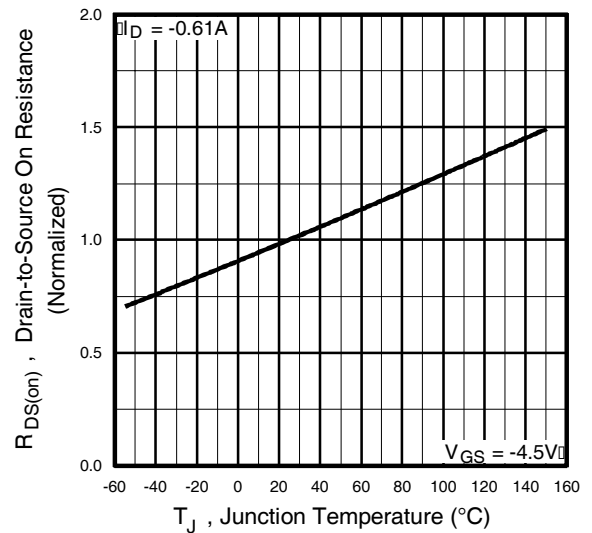
**Fig 1.** Typical Output Characteristics



**Fig 2.** Typical Output Characteristics



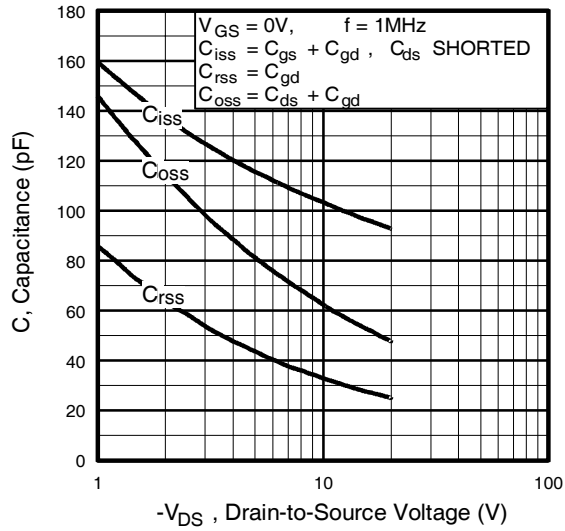
**Fig 3.** Typical Transfer Characteristics



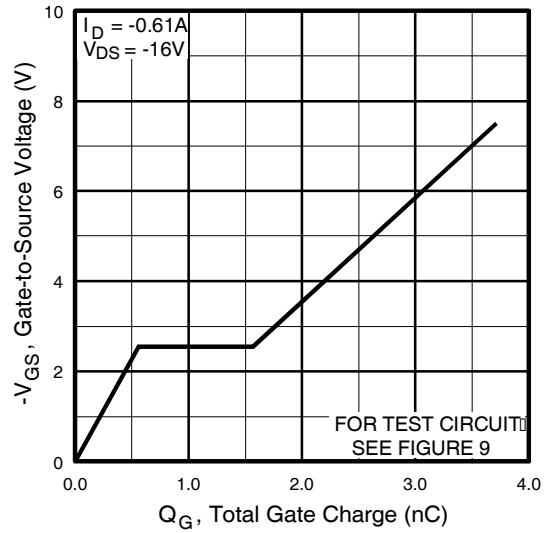
**Fig 4.** Normalized On-Resistance Vs. Temperature

# IRLML6302PbF

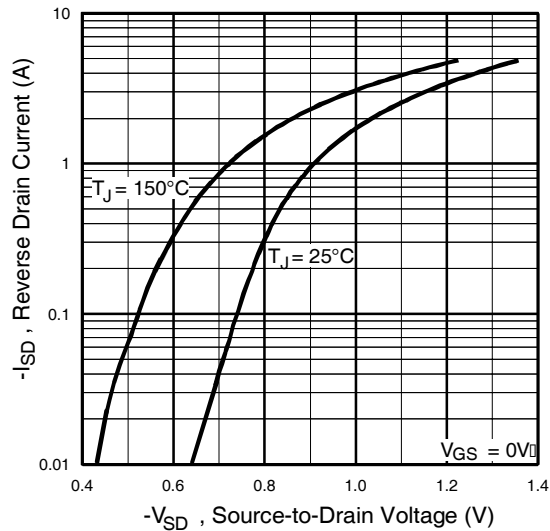
International  
**IR** Rectifier



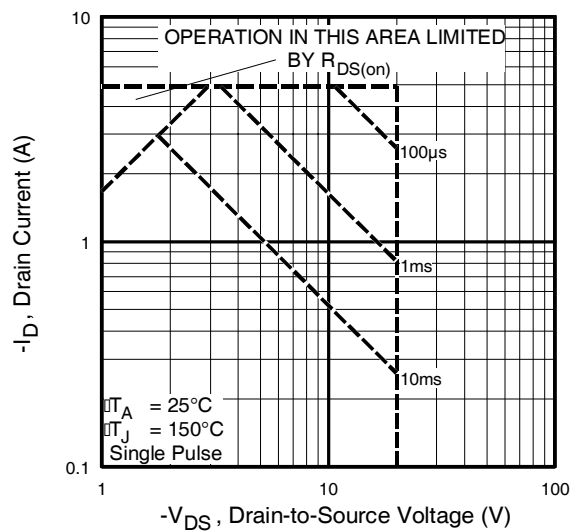
**Fig 5.** Typical Capacitance Vs. Drain-to-Source Voltage



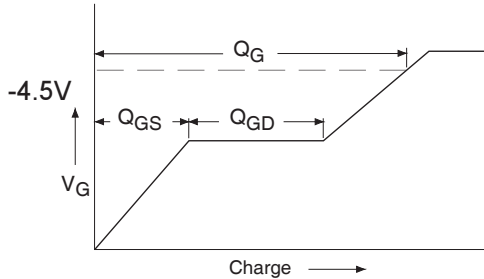
**Fig 6.** Typical Gate Charge Vs. Gate-to-Source Voltage



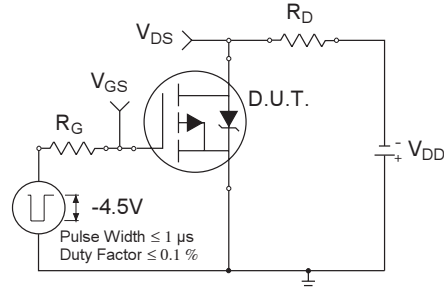
**Fig 7.** Typical Source-Drain Diode Forward Voltage



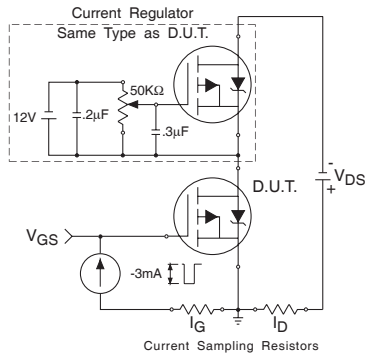
**Fig 8.** Maximum Safe Operating Area



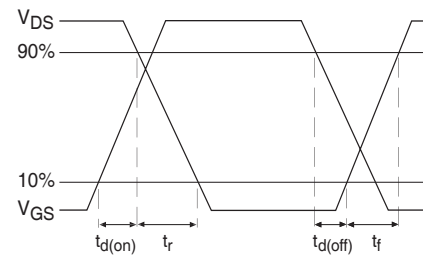
**Fig 9a.** Basic Gate Charge Waveform



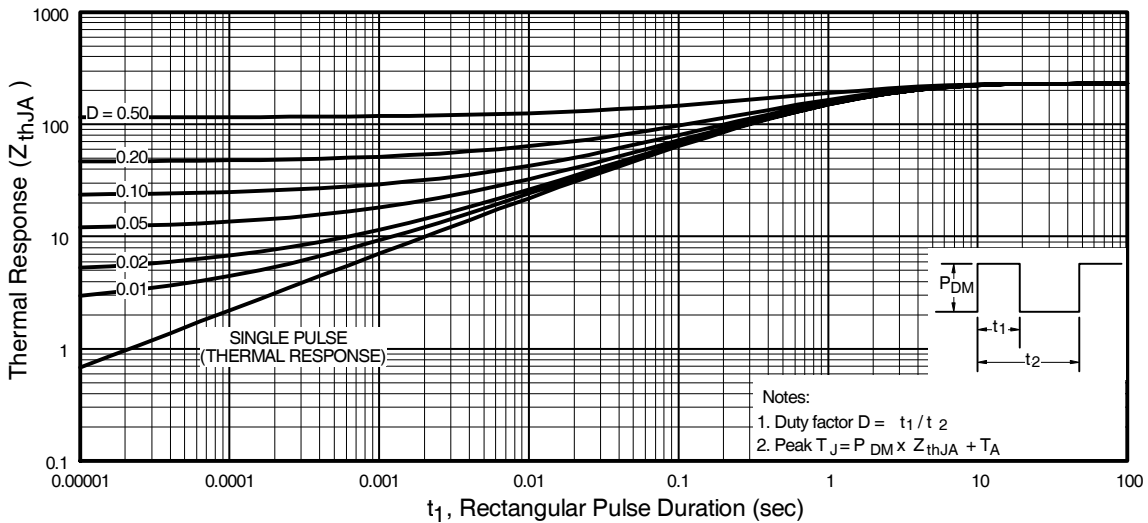
**Fig 10a.** Switching Time Test Circuit



**Fig 9b.** Gate Charge Test Circuit

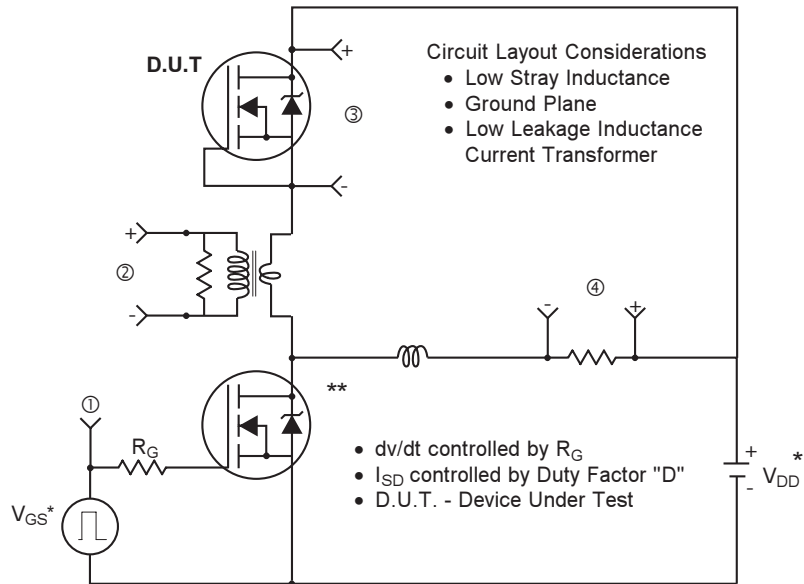


**Fig 10b.** Switching Time Waveforms



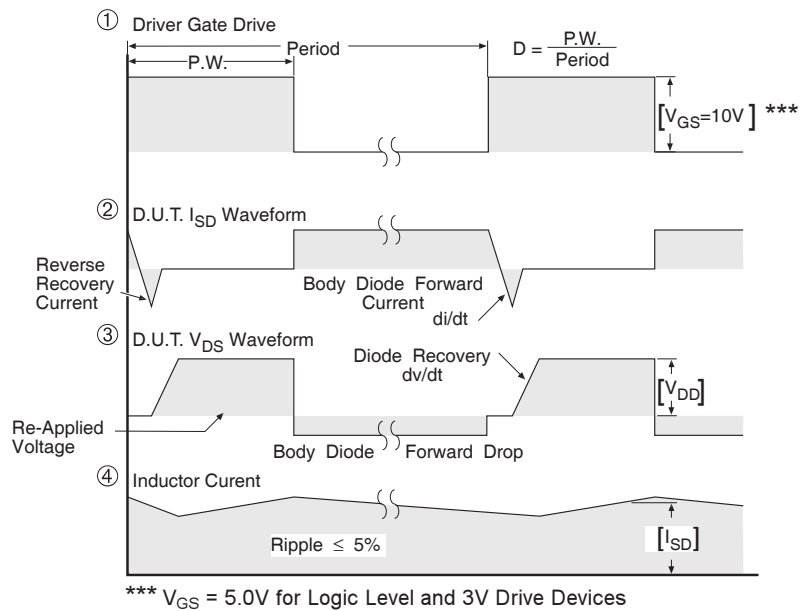
**Fig 11.** Maximum Effective Transient Thermal Impedance, Junction-to-Ambient

## Peak Diode Recovery dv/dt Test Circuit



\* Reverse Polarity for P-Channel

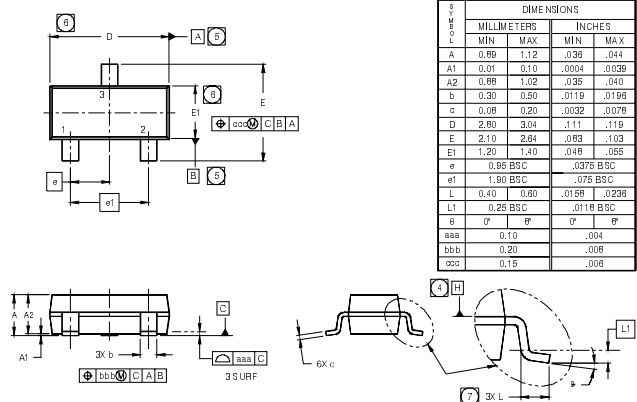
\*\* Use P-Channel Driver for P-Channel Measurements



**Fig 13.** For P-Channel HEXFETS

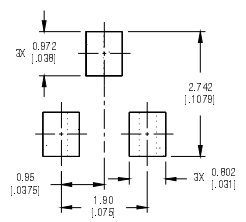
## Micro3 (SOT-23) (Lead-Free) Package Outline

Dimensions are shown in millimeters (inches)



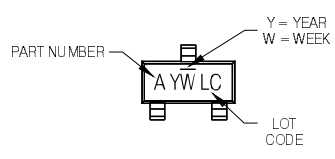
DIMENSION	DIMENSIONS			
	MILLIMETERS		INCHES	
	MIN	MAX	MIN	MAX
A	0.68	1.32	.035	.044
A1	0.01	0.10	.0004	.0039
A2	0.68	1.02	.035	.040
b	0.30	0.60	.0119	.0196
c	0.08	0.20	.0032	.0078
D	2.80	3.04	.111	.119
E	2.10	2.84	.083	.103
E1	1.20	1.40	.048	.055
e	0.65 BSC .0275 BSC			
e1	1.90 BSC .075 BSC			
L	0.40 .025 BSC .0159 BSC			
L1	0.25 BSC .0118 BSC			
b	Ø	Ø	Ø	Ø
bbb	0.10		.004	
bbb	0.20		.008	
ccc	0.15		.006	

RECOMMENDED FOOTPRINT



- NOTES
1. DIMENSIONING AND TOLERANCING PER ASME Y14.5M-1994.
  2. DIMENSIONS ARE SHOWN IN MILLIMETERS AND INCHES.
  3. CONTROLLING DIMENSION: MILLIMETER.
  4. DATUM PLANE H IS LOCATED AT THE MOLD PARTING LINE.
  5. DATUM A AND B TO BE DETERMINED AT DATUM PLANE H.
  6. DIMENSIONS D AND E1 ARE MEASURED AT DATUM PLANE H.
  7. DIMENSION L IS THE LEAD LENGTH FOR SOLDERING TO A SUBSTRATE.
  8. OUTLINE CONFORMS TO JEDEC OUTLINE TO-236AB.

## Micro3 (SOT-23 / TO-236AB) Part Marking Information



PART NUMBER CODE REFERENCE:

- A = IRLML2402
- B = IRLML2803
- C = IRLML6302
- D = IRLML5103
- E = IRLML6402
- F = IRLML6401
- G = IRLML2502
- H = IRLML5203

Note: A line above the work week (as shown here) indicates Lead-Free.

W = (1-26) IF PRECEDED BY LAST DIGIT OF CALENDAR YEAR

YEAR	Y	WORK WEEK	W
2001	1	01	A
2002	2	02	B
2003	3	03	C
2004	4	04	D
2005	5		
2006	6		
2007	7		
2008	8		
2009	9		
2010	0	24	X
		25	Y
		26	Z

W = (27-52) IF PRECEDED BY A LETTER

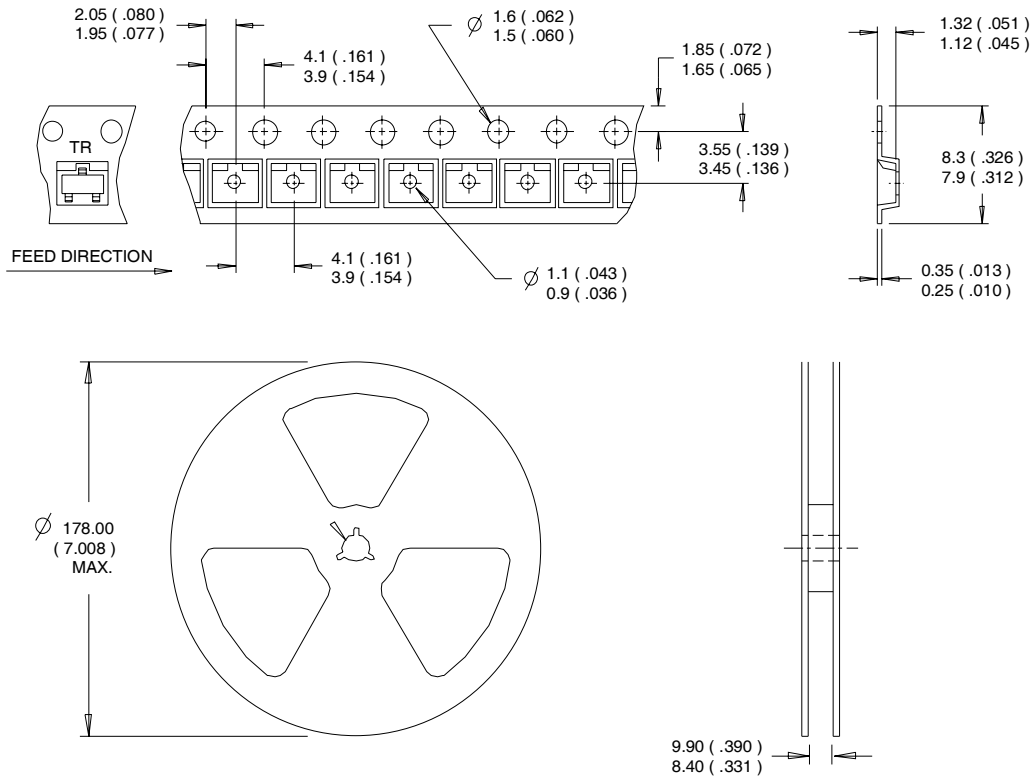
YEAR	Y	WORK WEEK	W
2001	A	27	A
2002	B	28	B
2003	C	29	C
2004	D	30	D
2005	E		
2006	F		
2007	G		
2008	H		
2009	J		
2010	K	50	X
		51	Y
		52	Z

# IRLML6302PbF

International  
**IR** Rectifier

## Micro3™ Tape & Reel Information

Dimensions are shown in millimeters (inches)



- NOTES:  
1. CONTROLLING DIMENSION : MILLIMETER.  
2. OUTLINE CONFORMS TO EIA-481 & EIA-541.

Data and specifications subject to change without notice.

International  
**IR** Rectifier

**IR WORLD HEADQUARTERS:** 233 Kansas St., El Segundo, California 90245, USA Tel: (310) 252-7105  
TAC Fax: (310) 252-7903

Visit us at [www.irf.com](http://www.irf.com) for sales contact information. 08/05