

High Voltage Synchronous Rectified Buck MOSFET Driver

The ISL6208 is a high frequency, dual MOSFET driver, optimized to drive two N-Channel power MOSFETs in a synchronous-rectified buck converter topology. It is especially suited for mobile computing applications that require high efficiency and excellent thermal performance. This driver, combined with an Intersil multiphase Buck PWM controller, forms a complete single-stage core-voltage regulator solution for advanced mobile microprocessors.

The ISL6208 features 4A typical sinking current for the lower gate driver. This current is capable of holding the lower MOSFET gate off during the rising edge of the Phase node. This prevents shoot-through power loss caused by the high dv/dt of phase voltages. The operating voltage matches the 30V breakdown voltage of the MOSFETs commonly used in mobile computer power supplies.

The ISL6208 also features a three-state PWM input that, working together with Intersil's multiphase PWM controllers, will prevent negative voltage output during CPU shutdown. This feature eliminates a protective Schottky diode usually seen in a microprocessor power systems.

MOSFET gates can be efficiently switched up to 2MHz using the ISL6208. Each driver is capable of driving a 3000pF load with propagation delays of 8ns and transition times under 10ns. Bootstrapping is implemented with an internal Schottky diode. This reduces system cost and complexity, while allowing the use of higher performance MOSFETs. Adaptive shoot-through protection is integrated to prevent both MOSFETs from conducting simultaneously.

A diode emulation feature is integrated in the ISL6208 to enhance converter efficiency at light load conditions. This feature also allows for monotonic start-up into pre-biased outputs. When diode emulation is enabled, the driver will allow discontinuous conduction mode by detecting when the inductor current reaches zero and subsequently turning off the low side MOSFET gate.

Related Literature

- Technical Brief TB363 "Guidelines for Handling and Processing Moisture Sensitive Surface Mount Devices (SMDs)"
- Technical Brief TB389 "PCB Land Pattern Design and Surface Mount Guidelines for MLFP Packages"

Features

- Dual MOSFET Drives for Synchronous Rectified Bridge
- Adaptive Shoot-Through Protection
- 0.5Ω On-Resistance and 4A Sink Current Capability
- Supports High Switching Frequency up to 2MHz
 - Fast Output Rise and Fall Time
 - Low Propagation Delay
- Three-State PWM Input for Power Stage Shutdown
- Internal Bootstrap Schottky Diode
- Low Bias Supply Current (5V, 80μA)
- Diode Emulation for Enhanced Light Load Efficiency and Pre-Biased Startup Applications
- VCC POR (Power-On-Reset) Feature Integrated
- Low Three-State Shutdown Holdoff Time (Typical 160ns)
- Pin-to-pin Compatible with ISL6207
- QFN Package:
 - Compliant to JEDEC PUB95 MO-220 QFN - Quad Flat No Leads - Package Outline
 - Near Chip Scale Package footprint, which improves PCB efficiency and has a thinner profile
- Lead-Free Available as an Option

Applications

- Core Voltage Supplies for Intel® and AMD® Mobile Microprocessors
- High Frequency Low Profile DC-DC Converters
- High Current Low Output Voltage DC-DC Converters
- High Input Voltage DC-DC Converters

Ordering Information

PART NUMBER	TEMP. RANGE (°C)	PACKAGE	PKG. DWG. #
ISL6208CB	-10 to 100	8 Ld SOIC	M8.15
ISL6208CBZ (Note)	-10 to 100	8 Ld SOIC (Lead-Free)	M8.15
ISL6208CB-T	8 Ld SOIC Tape and Reel		
ISL6208CBZ-T (Note)	8 Ld SOIC Tape and Reel (Lead-Free)		
ISL6208CR	-10 to 100	8 Ld 3x3 QFN	L8.3x3
ISL6208CRZ (Note)	-10 to 100	8 Ld 3x3 QFN (Lead-Free)	L8.3x3
ISL6208CR-T	8 Ld 3x3 QFN Tape and Reel		
ISL6208CRZ-T (Note)	8 Ld 3x3 QFN Tape and Reel (Lead-Free)		

NOTE: Intersil Lead-Free products employ special lead-free material sets; molding compounds/die attach materials and 100% matte tin plate termination finish, which is compatible with both SnPb and lead-free soldering operations. Intersil Lead-Free products are MSL classified at lead-free peak reflow temperatures that meet or exceed the lead-free requirements of IPC/JEDEC J Std-020B.

Pinouts

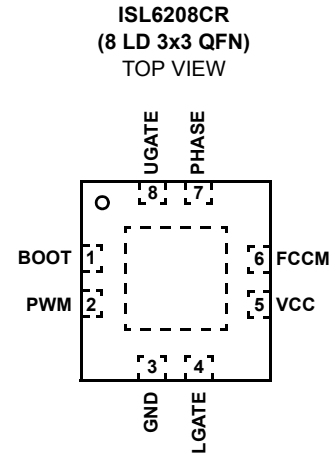
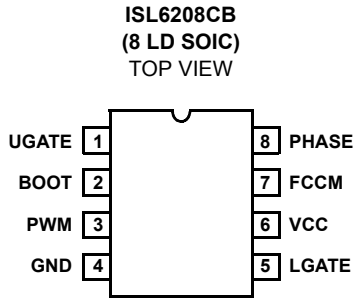

Absolute Maximum Ratings

Supply Voltage (VCC)	-0.3V to 7V
BOOT Voltage (V _{BOOT})	-0.3V to 33V
Phase Voltage (V _{PHASE}) (Note 1)	V _{BOOT} - 7V to V _{BOOT} + 0.3V
Input Voltage (V _{FCCM} , V _{PWM})	-0.3V to VCC + 0.3V
UGATE	V _{PHASE} - 0.3V to V _{BOOT} + 0.3V
LGATE	-0.3V to VCC + 0.3V
Ambient Temperature Range	-40°C to 125°C

Thermal Information

Thermal Resistance (Typical Notes 2, 3, 4) θ_{JA} (°C/W)	θ_{JC} (°C/W)
SOIC Package (Note 2)	110 n/a
QFN Package (Notes 3, 4)	80 15
Maximum Junction Temperature (Plastic Package)	150°C
Maximum Storage Temperature Range	-65°C to 150°C
Maximum Lead Temperature (Soldering 10s)	300°C (SOIC - Lead Tips Only)

Recommended Operating Conditions

Ambient Temperature Range	-10°C to 100°C
Maximum Operating Junction Temperature	125°C
Supply Voltage, VCC	5V ±10%

CAUTION: Stresses above those listed in "Absolute Maximum Ratings" may cause permanent damage to the device. This is a stress only rating and operation of the device at these or any other conditions above those indicated in the operational sections of this specification is not implied.

NOTES:

1. The Phase Voltage is capable of withstanding -7V when the BOOT pin is at GND.
2. θ_{JA} is measured with the component mounted on a high effective thermal conductivity test board in free air. See Tech Brief TB379 for details.
3. θ_{JA} is measured in free air with the component mounted on a high effective thermal conductivity test board with "direct attach" features. See Tech Brief TB379.
4. For θ_{JC} , the "case temp" location is the center of the exposed metal pad on the package underside.

Electrical Specifications Recommended Operating Conditions, Unless Otherwise Noted

PARAMETER	SYMBOL	TEST CONDITIONS	MIN	TYP	MAX	UNITS
VCC SUPPLY CURRENT						
Bias Supply Current	I _{VCC}	PWM pin floating, V _{FCCM} = 5V	-	80	-	μA
POR			-	-	-	
Vcc Rising			-	3.40	3.90	V
Vcc Falling			2.40	2.90	-	V
Hysteresis			-	500	-	mV
BOOTSTRAP DIODE						
Forward Voltage	V _F	V _{VCC} = 5V, forward bias current = 2mA	0.40	0.52	0.60	V
PWM INPUT						
Input Current	I _{PWM}	V _{PWM} = 5V	-	250	-	μA
		V _{PWM} = 0V	-	-250	-	μA
PWM Three-State Rising Threshold		V _{VCC} = 5V	0.70	1.00	1.30	V
PWM Three-State Falling Threshold		V _{VCC} = 5V	3.5	3.8	4.1	V
Three-State Shutdown Holdoff Time	t _{TSSHD}	V _{VCC} = 5V, temperature = 25°C	100	175	250	ns
FCCM INPUT						
FCCM LOW Threshold			0.50	-	-	V
FCCM HIGH Threshold			-	-	2.0	V
SWITCHING TIME						
UGATE Rise Time	t _{RU}	V _{VCC} = 5V, 3nF Load	-	8.0	-	ns
LGATE Rise Time	t _{RL}	V _{VCC} = 5V, 3nF Load	-	8.0	-	ns
UGATE Fall Time	t _{FU}	V _{VCC} = 5V, 3nF Load	-	8.0	-	ns
LGATE Fall Time	t _{FL}	V _{VCC} = 5V, 3nF Load	-	4.0	-	ns

ISL6208

Electrical Specifications Recommended Operating Conditions, Unless Otherwise Noted (Continued)

PARAMETER	SYMBOL	TEST CONDITIONS	MIN	TYP	MAX	UNITS
UGATE Turn-Off Propagation Delay	t_{PDLU}	$V_{VCC} = 5V$, Outputs Unloaded	-	35	-	ns
LGATE Turn-Off Propagation Delay	t_{PDLL}	$V_{VCC} = 5V$, Outputs Unloaded	-	35	-	ns
UGATE Turn-On Propagation Delay	t_{PDHU}	$V_{VCC} = 5V$, Outputs Unloaded	-	20	-	ns
LGATE Turn-On Propagation Delay	t_{PDHL}	$V_{VCC} = 5V$, Outputs Unloaded	-	20	-	ns
UG/LG Three-state Propagation Delay	t_{PTS}	$V_{VCC} = 5V$, Outputs Unloaded	-	35	-	ns
Minimum LG On TIME in DCM (Note 5)	t_{LGMIN}		-	400	-	ns
OUTPUT						
Upper Drive Source Resistance	R_U	500mA Source Current	-	1	2.5	Ω
Upper Driver Source Current (Note 5)	I_U	$V_{UGATE-PHASE} = 2.5V$	-	2.00	-	A
Upper Drive Sink Resistance	R_U	500mA Sink Current	-	1	2.5	Ω
Upper Driver Sink Current (Note 5)	I_U	$V_{UGATE-PHASE} = 2.5V$	-	2.00	-	A
Lower Drive Source Resistance	R_L	500mA Source Current	-	1	2.5	Ω
Lower Driver Source Current (Note 5)	I_L	$V_{LGATE} = 2.5V$	-	2.00	-	A
Lower Drive Sink Resistance	R_L	500mA Sink Current	-	0.5	1.0	Ω
Lower Driver Sink Current (Note 5)	I_L	$V_{LGATE} = 2.5V$	-	4.00	-	A

NOTE:

5. Guaranteed by design, not tested.

Functional Pin Description

UGATE (Pin 1 for SOIC-8, Pin 8 for QFN)

The UGATE pin is the upper gate drive output. Connect to the gate of high-side power N-Channel MOSFET.

BOOT (Pin 2 for SOIC-8, Pin 1 for QFN)

BOOT is the floating bootstrap supply pin for the upper gate drive. Connect the bootstrap capacitor between this pin and the PHASE pin. The bootstrap capacitor provides the charge to turn on the upper MOSFET. See the Bootstrap Diode and Capacitor section under DESCRIPTION for guidance in choosing the appropriate capacitor value.

PWM (Pin 3 for SOIC-8, Pin 2 for QFN)

The PWM signal is the control input for the driver. The PWM signal can enter three distinct states during operation (see the three-state PWM Input section under DESCRIPTION for further details). Connect this pin to the PWM output of the controller.

GND (Pin 4 for SOIC-8, Pin 3 for QFN)

GND is the ground pin for the IC.

LGATE (Pin 5 for SOIC-8, Pin 4 for QFN)

LGATE is the lower gate drive output. Connect to gate of the low-side power N-Channel MOSFET.

VCC (Pin 6 for SOIC-8, Pin 5 for QFN)

Connect the VCC pin to a +5V bias supply. Place a high quality bypass capacitor from this pin to GND.

FCCM (Pin 7 for SOIC-8, Pin 6 for QFN)

The FCCM pin enables or disables Diode Emulation. When FCCM is LOW, diode emulation is allowed. Otherwise,

continuous conduction mode is forced. See the Diode Emulation section under DESCRIPTION for more detail.

PHASE (Pin 8 for SOIC-8, Pin 7 for QFN)

Connect the PHASE pin to the source of the upper MOSFET and the drain of the lower MOSFET. This pin provides a return path for the upper gate driver.

Description

Theory of Operation

Designed for speed, the ISL6208 dual MOSFET driver controls both high-side and low-side N-Channel FETs from one externally provided PWM signal.

A rising edge on PWM initiates the turn-off of the lower MOSFET (see Timing Diagram). After a short propagation delay [t_{PDLL}], the lower gate begins to fall. Typical fall times [t_{FL}] are provided in the Electrical Specifications section. Adaptive shoot-through circuitry monitors the LGATE voltage. When LGATE has fallen below 1V, UGATE is allowed to turn ON. This prevents both the lower and upper MOSFETs from conducting simultaneously, or shoot-through.

A falling transition on PWM indicates the turn-off of the upper MOSFET and the turn-on of the lower MOSFET. A short propagation delay [t_{PDLU}] is encountered before the upper gate begins to fall [t_{FU}]. The upper MOSFET gate-to-source voltage is monitored, and the lower gate is allowed to rise after the upper MOSFET gate-to-source voltage drops below 1V. The lower gate then rises [t_{RL}], turning on the lower MOSFET.

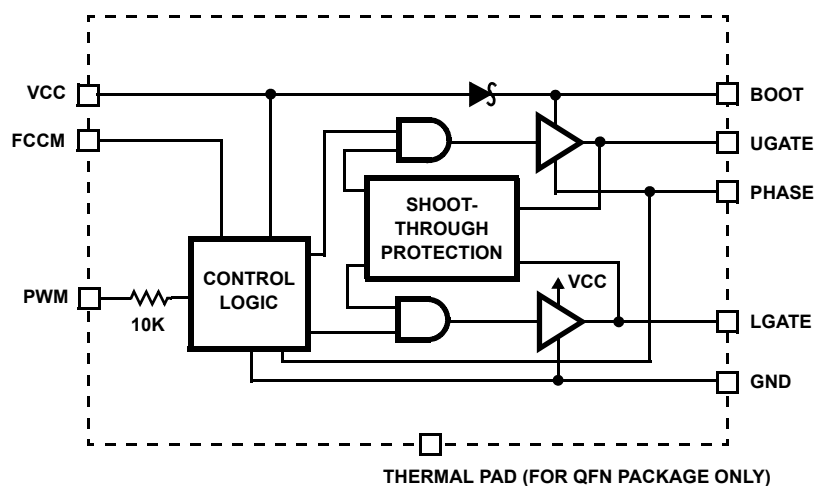
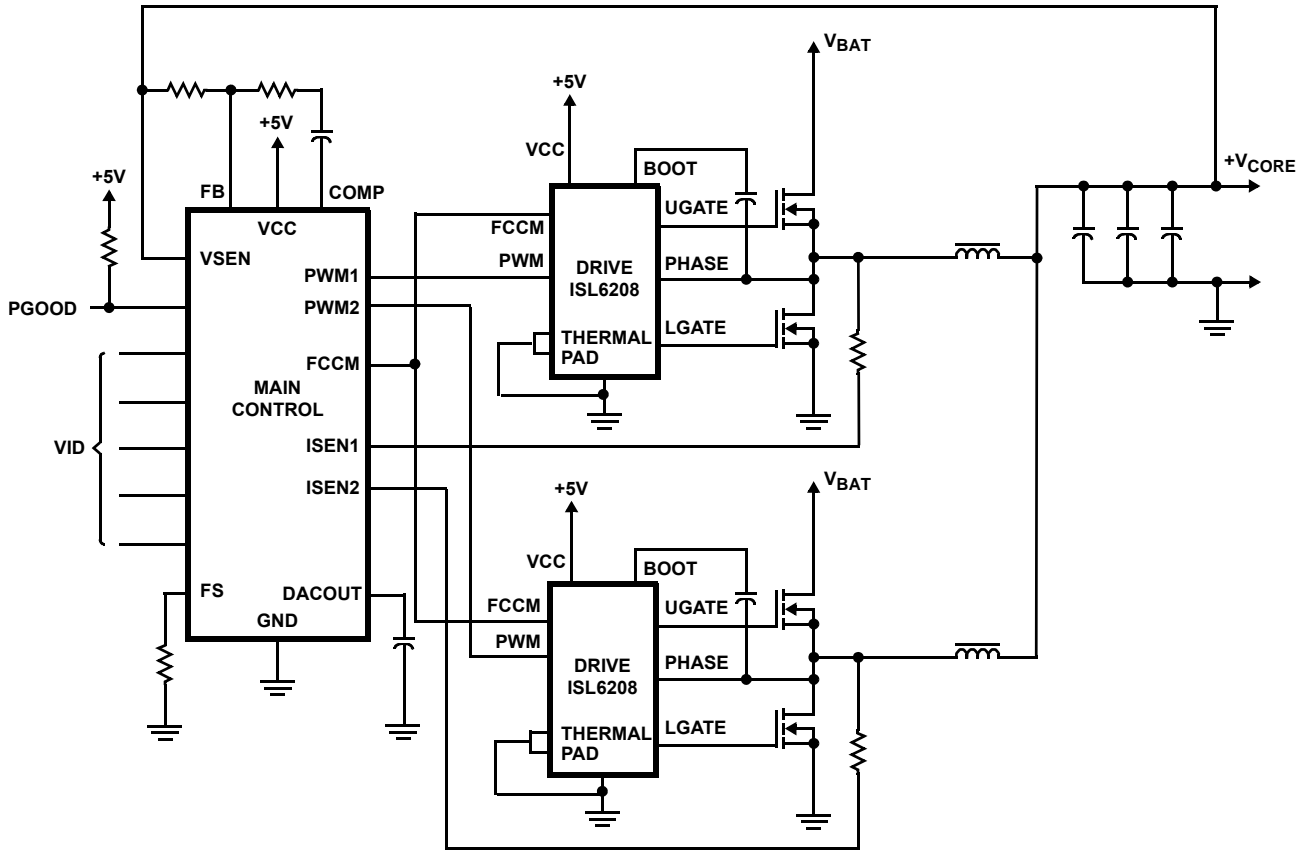
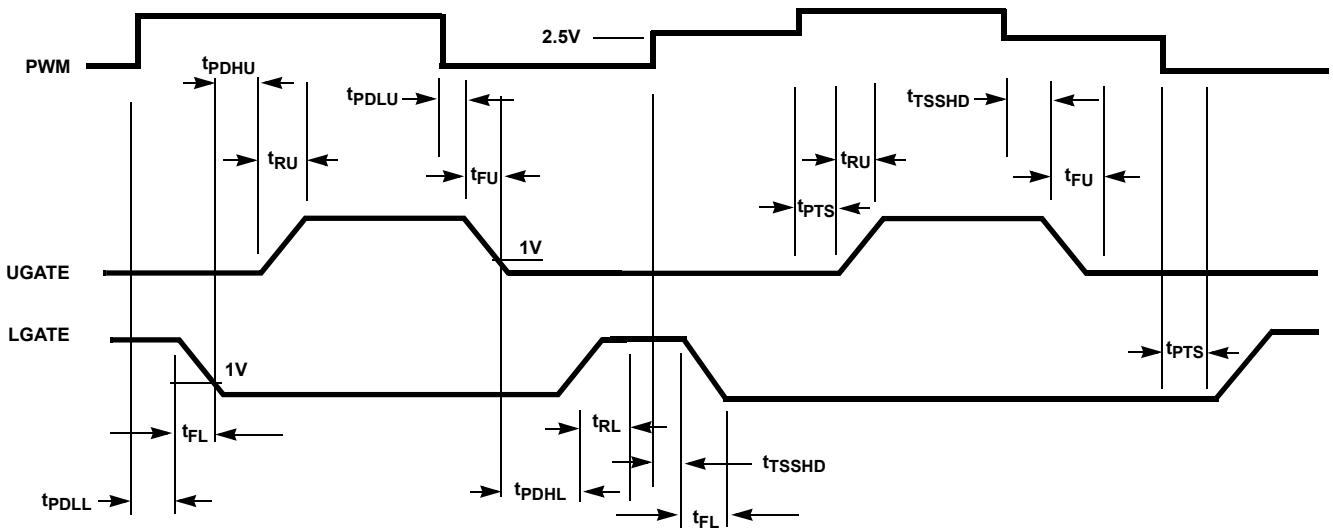

FIGURE 1. BLOCK DIAGRAM

Typical Application - Two Phase Converter Using ISL6208 Gate Drivers



Timing Diagram



This driver is optimized for converters with large step down compared to the upper MOSFET because the lower MOSFET conducts for a much longer time in a switching period. The lower gate driver is therefore sized much larger to meet this application requirement.

The 0.5Ω on-resistance and 4A sink current capability enable the lower gate driver to absorb the current injected to the lower gate through the drain-to-gate capacitor of the lower MOSFET and prevent a shoot through caused by the high dv/dt of the phase node.

Typical Performance Waveforms

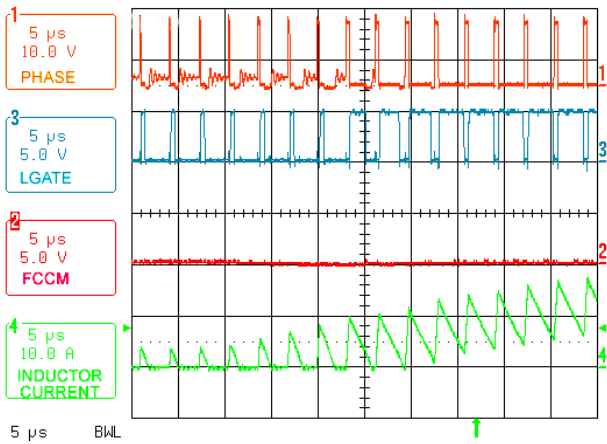

FIGURE 2. LOAD TRANSIENT (0 - 30A, 3-PHASE)

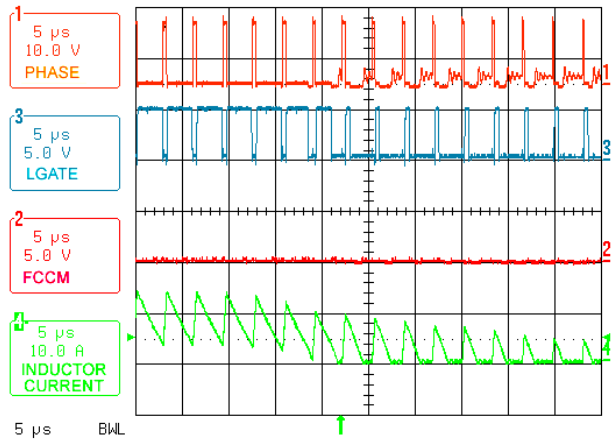

FIGURE 3. LOAD TRANSIENT (30 - 0A, 3-PHASE)

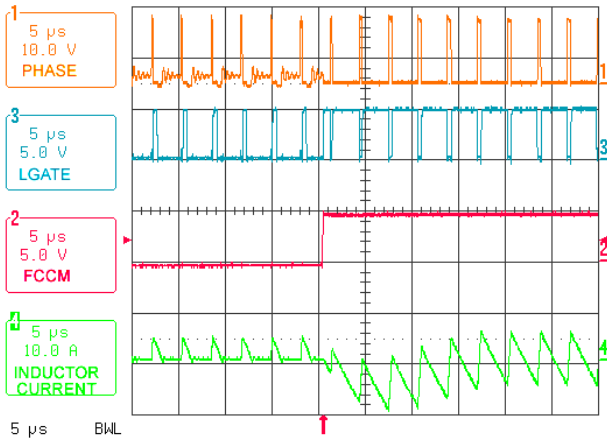

FIGURE 4. DCM TO CCM TRANSITION AT NO LOAD

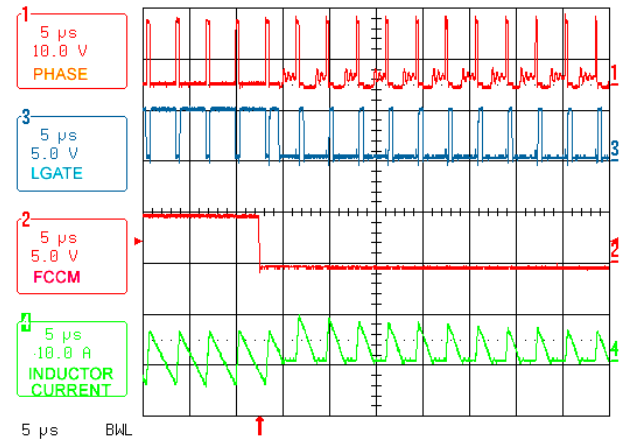

FIGURE 5. CCM TO DCM TRANSITION AT NO LOAD

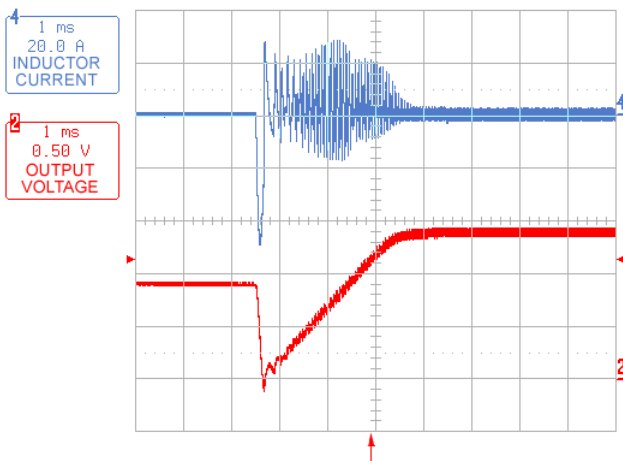

FIGURE 6. PRE-BIASED STARTUP IN CCM MODE

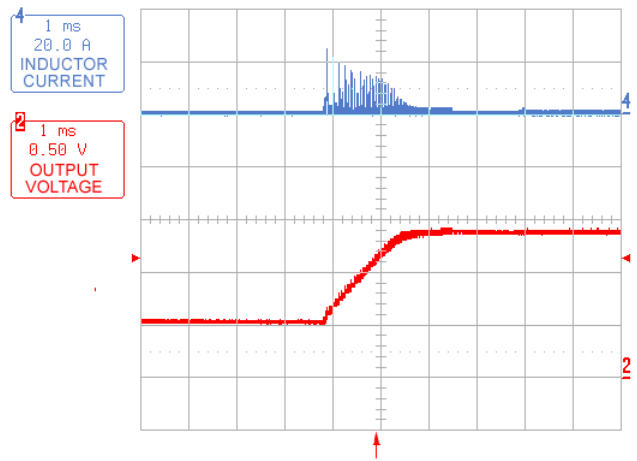

FIGURE 7. PRE-BIASED STARTUP IN DCM MODE

Diode Emulation

Diode emulation allows for higher converter efficiency under light-load situations. With diode emulation active, the ISL6208 will detect the zero current crossing of the output inductor and turn off LGATE. This ensures that discontinuous conduction mode (DCM) is achieved. Diode emulation is asynchronous to the PWM signal. Therefore, the ISL6208 will respond to the FCCM input immediately after it changes state. Refer to the waveforms on page 7.

NOTE: Intersil does not recommend Diode Emulation use with $r_{DS(ON)}$ current sensing topologies. The turn-OFF of the low side MOSFET can cause gross current measurement inaccuracies.

Three-State PWM Input

A unique feature of the ISL6208 and other Intersil drivers is the addition of a shutdown window to the PWM input. If the PWM signal enters and remains within the shutdown window for a set holdoff time, the output drivers are disabled and both MOSFET gates are pulled and held low. The shutdown state is removed when the PWM signal moves outside the shutdown window. Otherwise, the PWM rising and falling thresholds outlined in the ELECTRICAL SPECIFICATIONS determine when the lower and upper gates are enabled.

Adaptive Shoot-Through Protection

Both drivers incorporate adaptive shoot-through protection to prevent upper and lower MOSFETs from conducting simultaneously and shorting the input supply. This is accomplished by ensuring the falling gate has turned off one MOSFET before the other is allowed to turn on.

During turn-off of the lower MOSFET, the LGATE voltage is monitored until it reaches a 1V threshold, at which time the UGATE is released to rise. Adaptive shoot-through circuitry monitors the upper MOSFET gate-to-source voltage during UGATE turn-off. Once the upper MOSFET gate-to-source voltage has dropped below a threshold of 1V, the LGATE is allowed to rise.

Internal Bootstrap Diode

This driver features an internal bootstrap Schottky diode. Simply adding an external capacitor across the BOOT and PHASE pins completes the bootstrap circuit. The bootstrap capacitor must have a maximum voltage rating above the maximum battery voltage plus 5V. The bootstrap capacitor can be chosen from the following equation:

$$C_{BOOT} \geq \frac{Q_{GATE}}{\Delta V_{BOOT}} \tag{EQ. 1}$$

where Q_{GATE} is the amount of gate charge required to fully charge the gate of the upper MOSFET. The ΔV_{BOOT} term is defined as the allowable droop in the rail of the upper drive.

As an example, suppose an upper MOSFET has a gate charge, Q_{GATE} , of 25nC at 5V and also assume the droop in the drive voltage over a PWM cycle is 200mV. One will find that a bootstrap capacitance of at least 0.125 μ F is required. The next larger standard value capacitance is 0.15 μ F. A good quality ceramic capacitor is recommended.

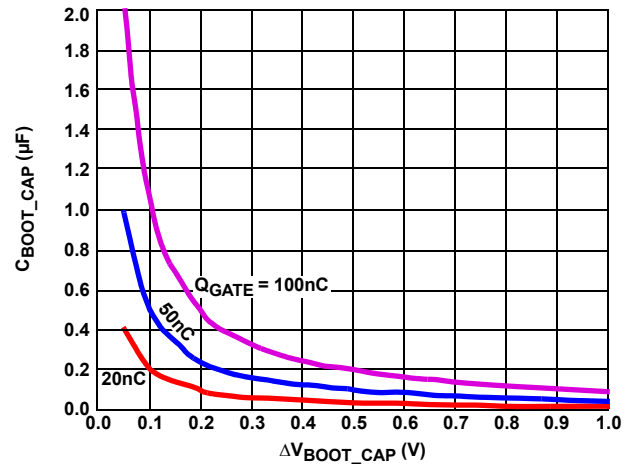

FIGURE 8. BOOTSTRAP CAPACITANCE vs BOOT RIPPLE VOLTAGE

Power Dissipation

Package power dissipation is mainly a function of the switching frequency and total gate charge of the selected MOSFETs. Calculating the power dissipation in the driver for a desired application is critical to ensuring safe operation. Exceeding the maximum allowable power dissipation level will push the IC beyond the maximum recommended operating junction temperature of 125°C. The maximum allowable IC power dissipation for the SO-8 package is approximately 800mW. When designing the driver into an application, it is recommended that the following calculation be performed to ensure safe operation at the desired frequency for the selected MOSFETs. The power dissipated by the driver is approximated as:

$$P = f_{sw}(1.5V_U Q_U + V_L Q_L) + I_{VCC} V_{CC} \tag{EQ. 2}$$

where f_{sw} is the switching frequency of the PWM signal. V_U and V_L represent the upper and lower gate rail voltage. Q_U and Q_L is the upper and lower gate charge determined by MOSFET selection and any external capacitance added to the gate pins. The $I_{VCC} V_{CC}$ product is the quiescent power of the driver and is typically negligible.

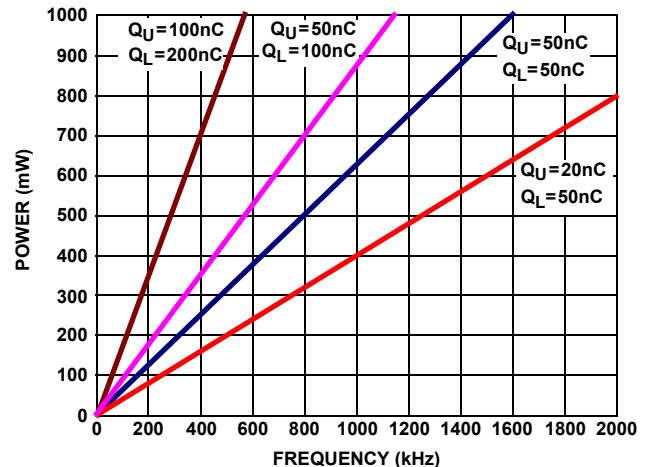
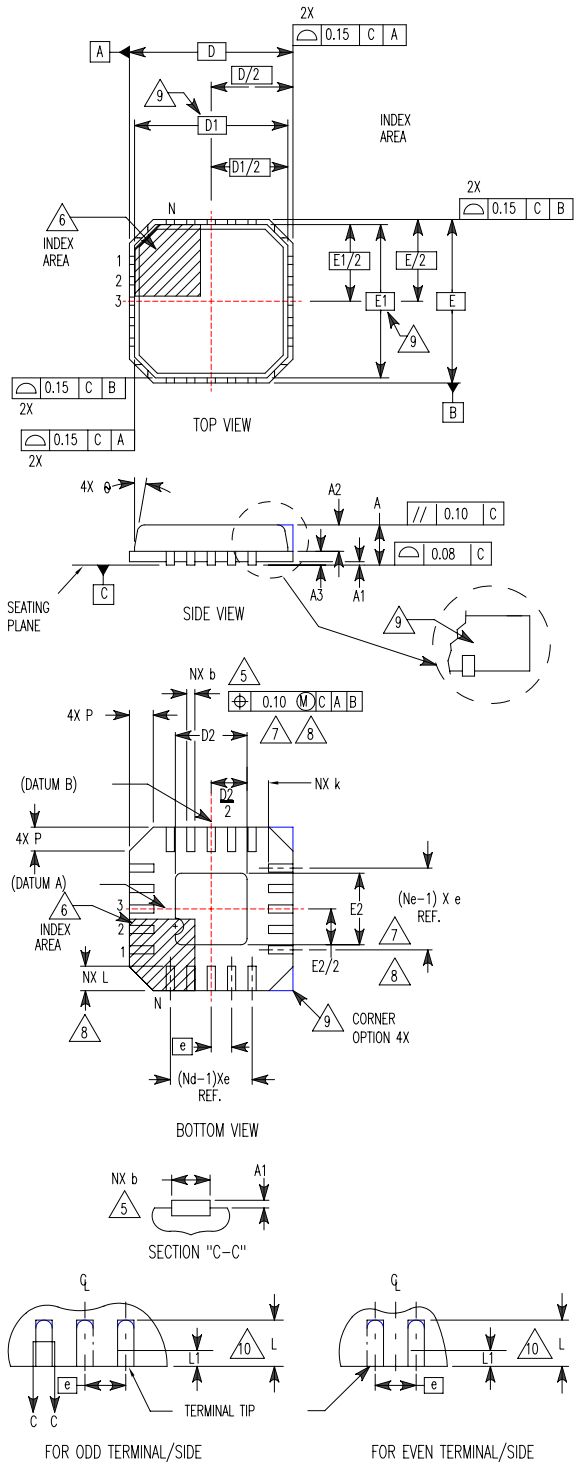

FIGURE 9. POWER DISSIPATION vs FREQUENCY

Quad Flat No-Lead Plastic Package (QFN)

L8.3x3

**8 LEAD QUAD FLAT NO-LEAD PLASTIC PACKAGE
(COMPLIANT TO JEDEC MO-220VEEC ISSUE C)**



SYMBOL	MILLIMETERS			NOTES
	MIN	NOMINAL	MAX	
A	0.80	0.90	1.00	-
A1	-	-	0.05	-
A2	-	-	1.00	9
A3	0.20 REF			9
b	0.23	0.28	0.38	5, 8
D	3.00 BSC			-
D1	2.75 BSC			9
D2	0.25	1.10	1.25	7, 8
E	3.00 BSC			-
E1	2.75 BSC			9
E2	0.25	1.10	1.25	7, 8
e	0.65 BSC			-
k	0.25		-	-
L	0.35	0.60	0.75	8
L1	-	-	0.15	10
N	8			2
Nd	2			3
Ne	2			3
P	-	-	0.60	9
θ	-	-	12	9

Rev. 1 10/02

NOTES:

1. Dimensioning and tolerancing conform to ASME Y14.5-1994.
2. N is the number of terminals.
3. Nd and Ne refer to the number of terminals on each D and E.
4. All dimensions are in millimeters. Angles are in degrees.
5. Dimension b applies to the metallized terminal and is measured between 0.15mm and 0.30mm from the terminal tip.
6. The configuration of the pin #1 identifier is optional, but must be located within the zone indicated. The pin #1 identifier may be either a mold or mark feature.
7. Dimensions D2 and E2 are for the exposed pads which provide improved electrical and thermal performance.
8. Nominal dimensions are provided to assist with PCB Land Pattern Design efforts, see Intersil Technical Brief TB389.
9. Features and dimensions A2, A3, D1, E1, P & θ are present when Anvil singulation method is used and not present for saw singulation.
10. Depending on the method of lead termination at the edge of the package, a maximum 0.15mm pull back (L1) maybe present. L minus L1 to be equal to or greater than 0.3mm.

Small Outline Plastic Packages (SOIC)

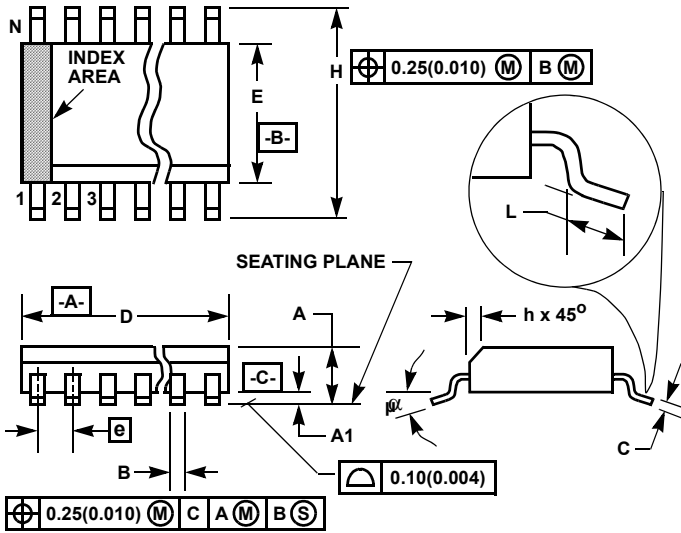

M8.15 (JEDEC MS-012-AA ISSUE C)
8 LEAD NARROW BODY SMALL OUTLINE PLASTIC PACKAGE

SYMBOL	INCHES		MILLIMETERS		NOTES
	MIN	MAX	MIN	MAX	
A	0.0532	0.0688	1.35	1.75	-
A1	0.0040	0.0098	0.10	0.25	-
B	0.013	0.020	0.33	0.51	9
C	0.0075	0.0098	0.19	0.25	-
D	0.1890	0.1968	4.80	5.00	3
E	0.1497	0.1574	3.80	4.00	4
e	0.050 BSC		1.27 BSC		-
H	0.2284	0.2440	5.80	6.20	-
h	0.0099	0.0196	0.25	0.50	5
L	0.016	0.050	0.40	1.27	6
N	8		8		7
α	0°	8°	0°	8°	-

NOTES:

1. Symbols are defined in the "MO Series Symbol List" in Section 2.2 of Publication Number 95.
2. Dimensioning and tolerancing per ANSI Y14.5M-1982.
3. Dimension "D" does not include mold flash, protrusions or gate burrs. Mold flash, protrusion and gate burrs shall not exceed 0.15mm (0.006 inch) per side.
4. Dimension "E" does not include interlead flash or protrusions. Interlead flash and protrusions shall not exceed 0.25mm (0.010 inch) per side.
5. The chamfer on the body is optional. If it is not present, a visual index feature must be located within the crosshatched area.
6. "L" is the length of terminal for soldering to a substrate.
7. "N" is the number of terminal positions.
8. Terminal numbers are shown for reference only.
9. The lead width "B", as measured 0.36mm (0.014 inch) or greater above the seating plane, shall not exceed a maximum value of 0.61mm (0.024 inch).
10. Controlling dimension: MILLIMETER. Converted inch dimensions are not necessarily exact.

Rev. 0 12/93

All Intersil U.S. products are manufactured, assembled and tested utilizing ISO9000 quality systems. Intersil Corporation's quality certifications can be viewed at www.intersil.com/design/quality

Intersil products are sold by description only. Intersil Corporation reserves the right to make changes in circuit design, software and/or specifications at any time without notice. Accordingly, the reader is cautioned to verify that data sheets are current before placing orders. Information furnished by Intersil is believed to be accurate and reliable. However, no responsibility is assumed by Intersil or its subsidiaries for its use; nor for any infringements of patents or other rights of third parties which may result from its use. No license is granted by implication or otherwise under any patent or patent rights of Intersil or its subsidiaries.

For information regarding Intersil Corporation and its products, see www.intersil.com