

PolarHV™ Power MOSFET

N-Channel Enhancement Mode
Fast Recovery Diode
Avalanche Rated

IXFH 26N60P
IXFQ 26N60P
IXFT 26N60P
IXFV 26N60P
IXFV 26N60PS

$V_{DSS} = 600 \text{ V}$
 $I_{D25} = 26 \text{ A}$
 $R_{DS(on)} \leq 270 \text{ m}\Omega$
 $t_{rr} \leq 200 \text{ ns}$

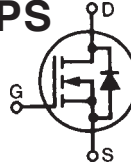

TO-247 (IXFH)

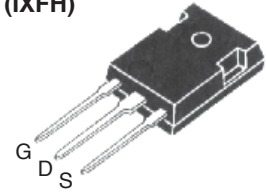

TO-3P (IXFQ)

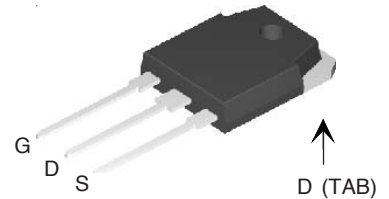

TO-268 (IXFT)

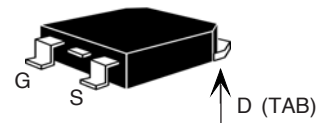

PLUS220 (IXFV)

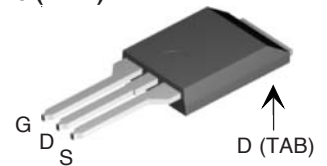

PLUS220SMD (IXFV_S)

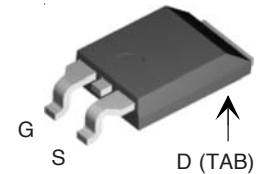

G = Gate
S = Source

D = Drain
TAB = Drain

| Symbol | Test Conditions | Maximum Ratings | |
|-----------|---|-----------------|--------------------------------------|
| | | | |
| V_{DSS} | $T_J = 25^\circ\text{C}$ to 150°C | 600 | V |
| V_{DGR} | $T_J = 25^\circ\text{C}$ to 150°C ; $R_{GS} = 1 \text{ M}\Omega$ | 600 | V |
| V_{GSS} | Continuous | ± 30 | V |
| V_{GSM} | Transient | ± 40 | V |
| I_{D25} | $T_C = 25^\circ\text{C}$ | 26 | A |
| I_{DM} | $T_C = 25^\circ\text{C}$, pulse width limited by T_{JM} | 65 | A |
| I_{AR} | $T_C = 25^\circ\text{C}$ | 26 | A |
| E_{AR} | $T_C = 25^\circ\text{C}$ | 40 | mJ |
| E_{AS} | $T_C = 25^\circ\text{C}$ | 1.2 | J |
| dv/dt | $I_S \leq I_{DM}$, $di/dt \leq 100 \text{ A}/\mu\text{s}$, $V_{DD} \leq V_{DSS}$ $T_J \leq 150^\circ\text{C}$, $R_G = 5 \Omega$ | 10 | V/ns |
| P_D | $T_C = 25^\circ\text{C}$ | 460 | W |
| T_J | | -55 ... +150 | $^\circ\text{C}$ |
| T_{JM} | | 150 | $^\circ\text{C}$ |
| T_{stg} | | -55 ... +150 | $^\circ\text{C}$ |
| T_L | 1.6 mm (0.062 in.) from case for 10 s Plastic body | 300 250 | $^\circ\text{C}$ $^\circ\text{C}$ |
| M_d | Mounting torque (TO-3P&TO-247) | 1.13/10 | Nm/lb.in. |
| F_c | Mounting force (PLUS220) | 11..65/2.5..15 | N/lb |
| Weight | TO-3P | 5.5 | g |
| | TO-248 | 6.0 | g |
| | TO-268 | 5.0 | g |
| | PLUS220 & PLUS220SMD | 4.0 | g |

| Symbol | Test Conditions | Characteristic Values | | |
|--------------|---|-----------------------|------|----------------------|
| | | Min. | Typ. | Max. |
| V_{DSS} | $V_{GS} = 0 \text{ V}$, $I_D = 250 \mu\text{A}$ | 600 | | V |
| $V_{GS(th)}$ | $V_{DS} = V_{GS}$, $I_D = 4 \text{ mA}$ | 2.5 | | V |
| I_{GSS} | $V_{GS} = \pm 30 \text{ V}$, $V_{DS} = 0$ | | | $\pm 100 \text{ nA}$ |
| I_{DSS} | $V_{DS} = V_{DSS}$ $V_{GS} = 0 \text{ V}$ $T_J = 125^\circ\text{C}$ | | | 25 μA |
| | | | | 250 μA |
| $R_{DS(on)}$ | $V_{GS} = 10 \text{ V}$, $I_D = 0.5 I_{D25}$ Pulse test, $t \leq 300 \mu\text{s}$, duty cycle $d \leq 2\%$ | | | 270 $\text{m}\Omega$ |

Features

- Fast Recovery diode
- Unclamped Inductive Switching (UIS) rated
- International standard packages
- Low package inductance
- easy to drive and to protect

Advantages

- Easy to mount
- Space savings
- High power density

| Symbol | Test Conditions | Characteristic Values ($T_J = 25^\circ\text{C}$, unless otherwise specified) | | |
|--------------|--|---|------|----------|
| | | Min. | Typ. | Max. |
| g_{fs} | $V_{DS} = 20\text{ V}; I_D = 0.5 I_{D25}$, pulse test | 16 | 26 | S |
| C_{iss} | $V_{GS} = 0\text{ V}, V_{DS} = 25\text{ V}, f = 1\text{ MHz}$ | | 4150 | pF |
| C_{oss} | | | 400 | pF |
| C_{rss} | | | 27 | pF |
| $t_{d(on)}$ | $V_{GS} = 10\text{ V}, V_{DS} = 0.5 I_{D25}$ $R_G = 5\ \Omega$ (External) | | 25 | ns |
| t_r | | | 27 | ns |
| $t_{d(off)}$ | | | 75 | ns |
| t_f | | | 21 | ns |
| $Q_{g(on)}$ | $V_{GS} = 10\text{ V}, V_{DS} = 0.5 V_{DSS}, I_D = 0.5 I_{D25}$ | | 72 | nC |
| Q_{gs} | | | 27 | nC |
| Q_{gd} | | | 24 | nC |
| R_{thJC} | TO-3P, PLUS220 & TO-247 | | | 0.27 K/W |
| R_{thCK} | | | 0.21 | K/W |

| Source-Drain Diode | | Characteristic Values ($T_J = 25^\circ\text{C}$, unless otherwise specified) | | |
|--------------------|--|---|------|---------------|
| Symbol | Test Conditions | Min. | Typ. | Max. |
| I_S | $V_{GS} = 0\text{ V}$ | | | 26 A |
| I_{SM} | Repetitive | | | 78 A |
| V_{SD} | $I_F = I_S, V_{GS} = 0\text{ V}$, pulse test | | | 1.5 V |
| t_{rr} | $I_F = 25\text{ A}, -di/dt = 100\text{ A}/\mu\text{s}$ | | 150 | 250 ns |
| I_{RM} | $V_R = 100\text{ V}; V_{GS} = 0\text{ V}$ | | 7 | A |
| Q_{RM} | | | 0.7 | μC |

Characteristic Curves

Fig. 1. Output Characteristics @ 25°C

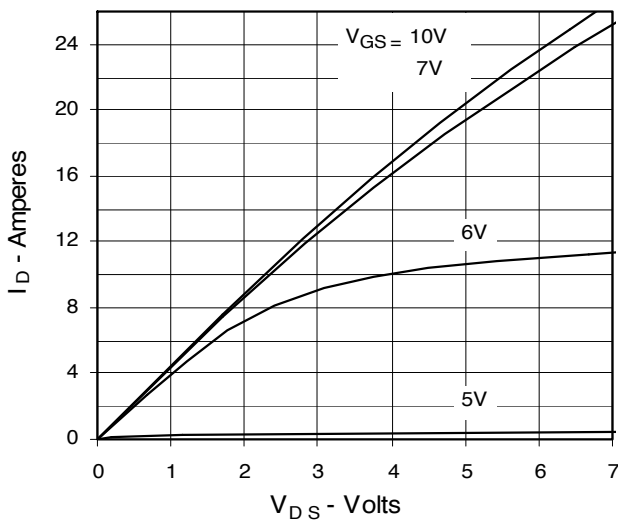
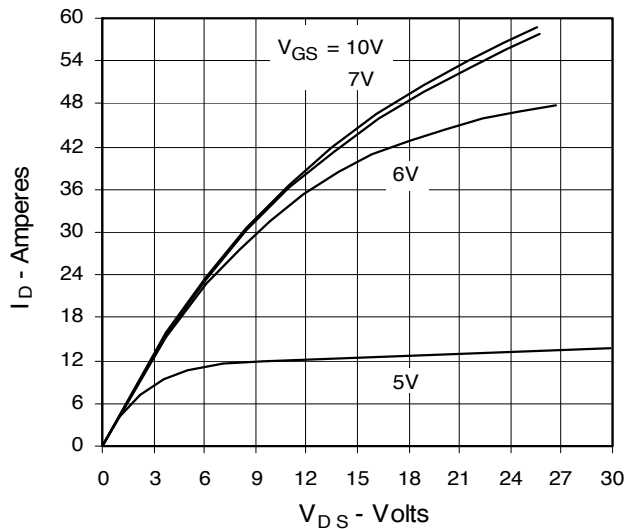

Fig. 2. Extended Output Characteristics @ 25°C



IXYS reserves the right to change limits, test conditions, and dimensions.

| | | | | | | | | |
|--|-----------|-----------|-----------|-----------|--------------|--------------|--------------|-----------|
| IXYS MOSFETs and IGBTs are covered by one or more of the following U.S. patents: | 4,835,592 | 4,931,844 | 5,049,961 | 5,237,481 | 6,162,665 | 6,404,065 B1 | 6,683,344 | 6,727,585 |
| | 4,850,072 | 5,017,508 | 5,063,307 | 5,381,025 | 6,259,123 B1 | 6,534,343 | 6,710,405 B2 | 6,759,692 |
| | 4,881,106 | 5,034,796 | 5,187,117 | 5,486,715 | 6,306,728 B1 | 6,583,505 | 6,710,463 | |

Fig. 3. Output Characteristics @ 125°C

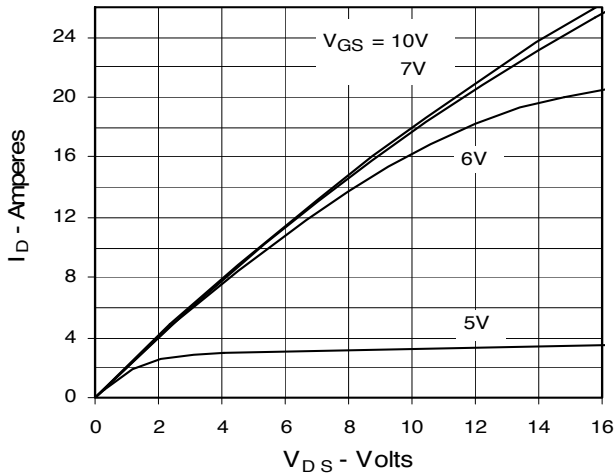

Fig. 4. $R_{DS(on)}$ Normalized to 0.5 I_{D25} Value vs. Junction Temperature

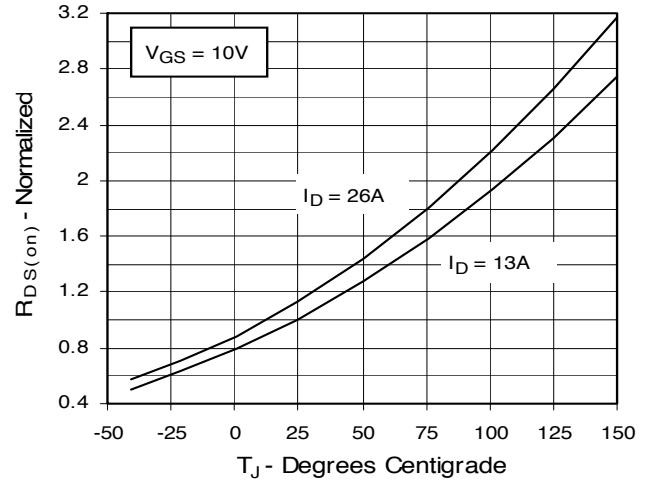

Fig. 5. $R_{DS(on)}$ Normalized to 0.5 I_{D25} Value vs. I_D

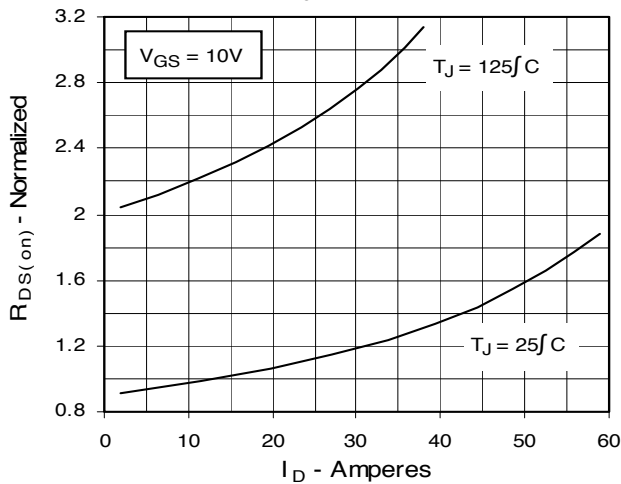

Fig. 6. Drain Current vs. Case Temperature

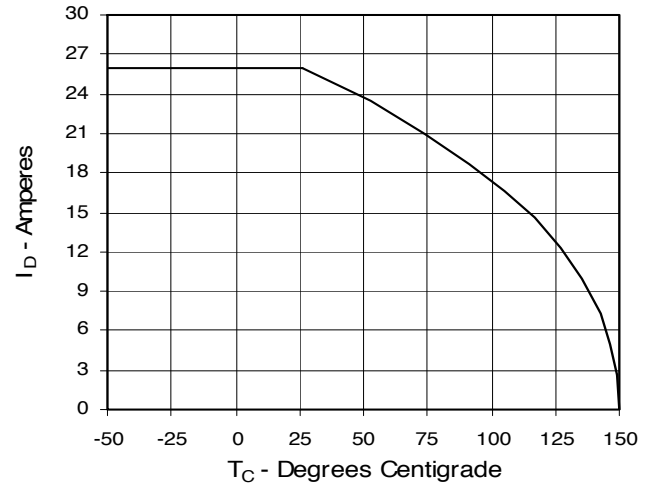

Fig. 7. Input Admittance

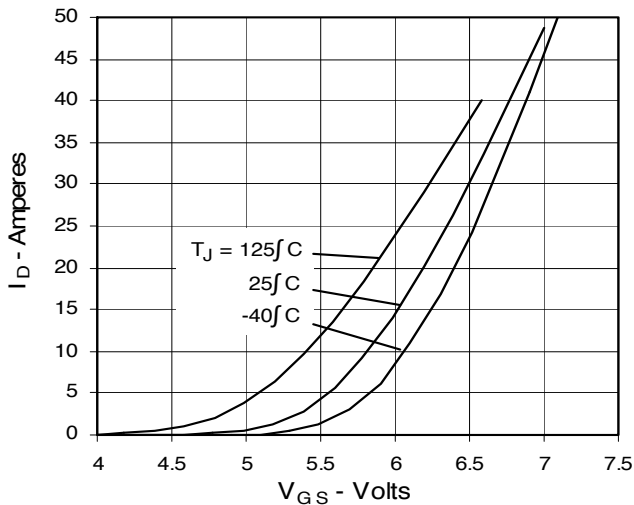

Fig. 8. Transconductance

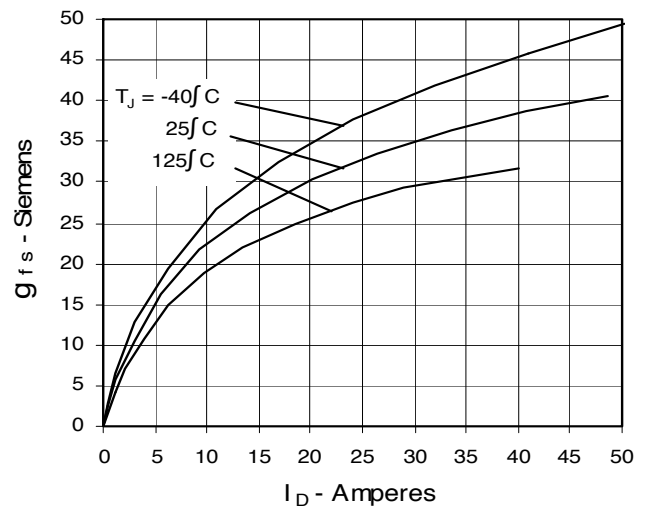

Fig. 9. Source Current vs. Source-To-Drain Voltage

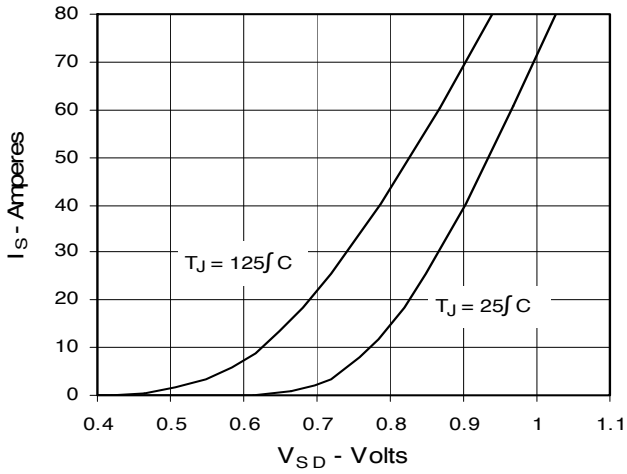

Fig. 10. Gate Charge

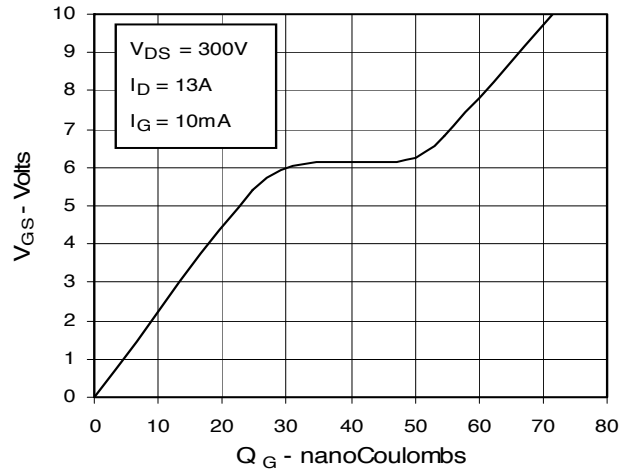

Fig. 11. Capacitance

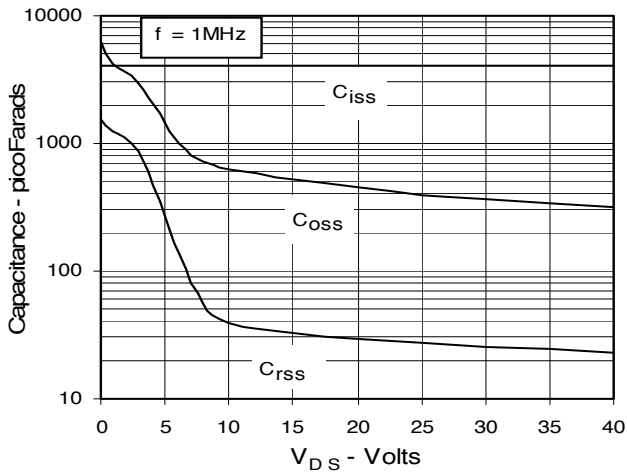
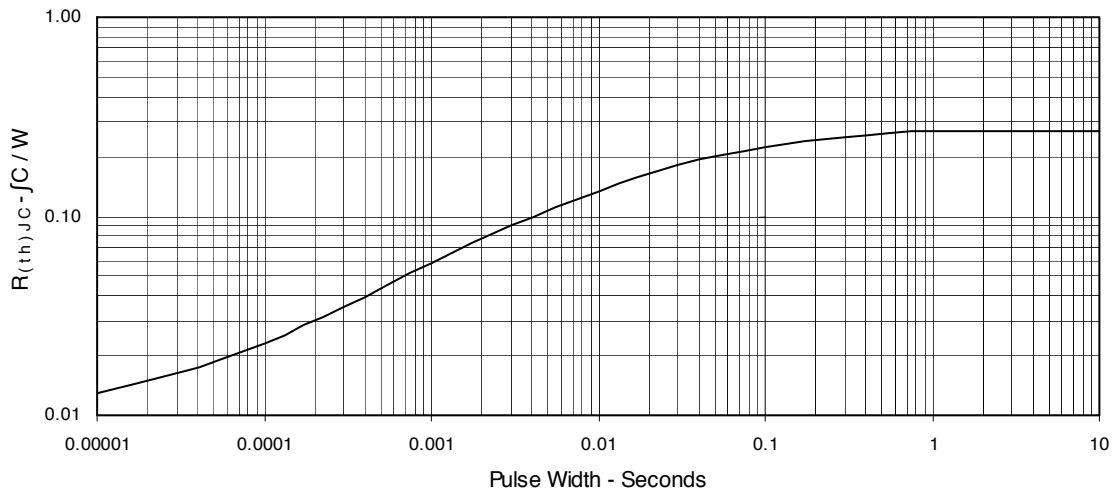
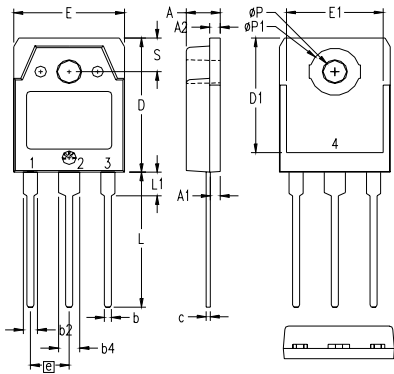

Fig. 12. Maximum Transient Thermal Resistance



TO-3P (IXFQ) Outline



| SYM | INCHES | | MILLIMETERS | |
|--------|----------|------|-------------|-------|
| | MIN | MAX | MIN | MAX |
| A | .185 | .193 | 4.70 | 4.90 |
| A1 | .051 | .059 | 1.30 | 1.50 |
| A2 | .057 | .065 | 1.45 | 1.65 |
| b | .035 | .045 | 0.90 | 1.15 |
| b2 | .075 | .087 | 1.90 | 2.20 |
| b4 | .114 | .126 | 2.90 | 3.20 |
| c | .022 | .031 | 0.55 | 0.80 |
| D | .780 | .791 | 19.80 | 20.10 |
| D1 | .665 | .677 | 16.90 | 17.20 |
| E | .610 | .622 | 15.50 | 15.80 |
| E1 | .531 | .539 | 13.50 | 13.70 |
| e | .215 BSC | | 5.45 BSC | |
| L | .779 | .795 | 19.80 | 20.20 |
| L1 | .134 | .142 | 3.40 | 3.60 |
| phi P | .126 | .134 | 3.20 | 3.40 |
| phi P1 | .272 | .280 | 6.90 | 7.10 |
| S | .193 | .201 | 4.90 | 5.10 |

All metal area are tin plated.

TO-247 AD (IXFH) Outline

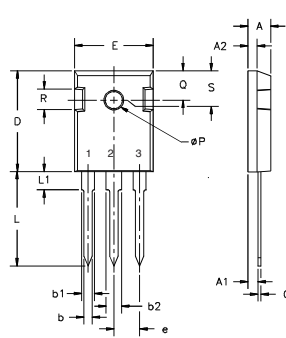

| Dim. | Millimeter | | Inches | |
|------|------------|-------|--------|-------|
| | Min. | Max. | Min. | Max. |
| A | 4.7 | 5.3 | .185 | .209 |
| A1 | 2.2 | 2.54 | .087 | .102 |
| A2 | 2.2 | 2.6 | .059 | .098 |
| b | 1.0 | 1.4 | .040 | .055 |
| b1 | 1.65 | 2.13 | .065 | .084 |
| b2 | 2.87 | 3.12 | .113 | .123 |
| C | .4 | .8 | .016 | .031 |
| D | 20.80 | 21.46 | .819 | .845 |
| E | 15.75 | 16.26 | .610 | .640 |
| e | 5.20 | 5.72 | 0.205 | 0.225 |
| L | 19.81 | 20.32 | .780 | .800 |
| L1 | | 4.50 | | .177 |
| Q | 3.55 | 3.65 | .140 | .144 |
| R | 5.89 | 6.40 | 0.232 | 0.252 |
| S | 4.32 | 5.49 | .170 | .216 |
| | 6.15 | BSC | 242 | BSC |

TO-268 (IXFT) Outline

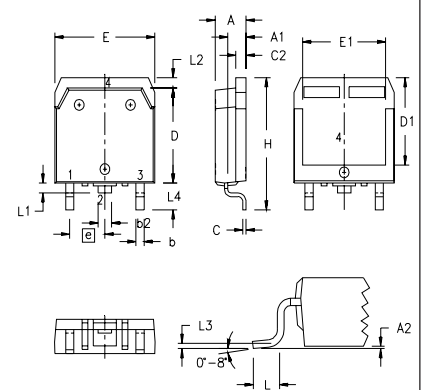

| SYM | INCHES | | MILLIMETERS | |
|-----|----------|------|-------------|-------|
| | MIN | MAX | MIN | MAX |
| A | .193 | .201 | 4.90 | 5.10 |
| A1 | .106 | .114 | 2.70 | 2.90 |
| A2 | .001 | .010 | 0.02 | 0.25 |
| b | .045 | .057 | 1.15 | 1.45 |
| b2 | .075 | .083 | 1.90 | 2.10 |
| C | .016 | .026 | 0.40 | 0.65 |
| C2 | .057 | .063 | 1.45 | 1.60 |
| D | .543 | .551 | 13.80 | 14.00 |
| D1 | .488 | .500 | 12.40 | 12.70 |
| E | .624 | .632 | 15.85 | 16.05 |
| E1 | .524 | .535 | 13.30 | 13.60 |
| e | .215 BSC | | 5.45 BSC | |
| H | .736 | .752 | 18.70 | 19.10 |
| L | .094 | .106 | 2.40 | 2.70 |
| L1 | .047 | .055 | 1.20 | 1.40 |
| L2 | .039 | .045 | 1.00 | 1.15 |
| L3 | .010 BSC | | 0.25 BSC | |
| L4 | .150 | .161 | 3.80 | 4.10 |

PLUS220 (IXFV) Outline

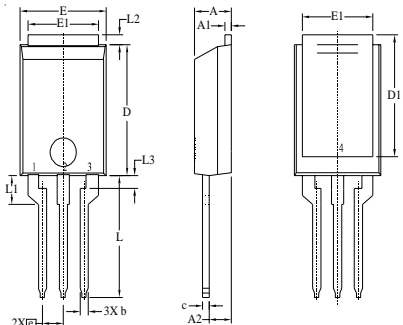

Terminals: 1 - Gate 2 - Drain
3 - Source TAB - Drain

| SYM | INCHES | | MILLIMETER | |
|-----|----------|------|------------|-------|
| | MIN | MAX | MIN | MAX |
| A | .169 | .185 | 4.30 | 4.70 |
| A1 | .028 | .035 | 0.70 | 0.90 |
| A2 | .098 | .118 | 2.50 | 3.00 |
| b | .035 | .047 | 0.90 | 1.20 |
| c | .028 | .035 | 0.70 | 0.90 |
| D | .551 | .591 | 14.00 | 15.00 |
| D1 | .512 | .539 | 13.00 | 13.70 |
| E | .394 | .433 | 10.00 | 11.00 |
| E1 | .331 | .346 | 8.40 | 8.80 |
| e | .100 BSC | | 2.54 BSC | |
| L | .512 | .551 | 13.00 | 14.00 |
| L1 | .118 | .138 | 3.00 | 3.50 |
| L2 | .035 | .051 | 0.90 | 1.30 |
| L3 | .047 | .059 | 1.20 | 1.50 |

PLUS220SMD (IXFV_S)

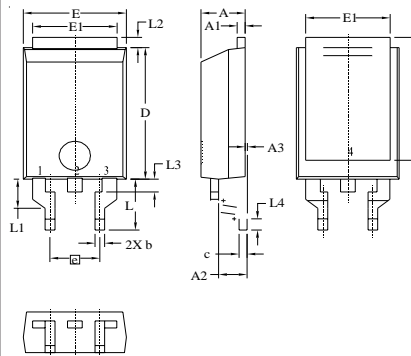

Terminals:
1 - Gate
2 - Drain
3 - Source
4 (TAB) - Drain

| SYM | INCHES | | MILLIMETER | |
|-----|---------|------|------------|-------|
| | MIN | MAX | MIN | MAX |
| A | .169 | .185 | 4.30 | 4.70 |
| A1 | .028 | .035 | 0.70 | 0.90 |
| A2 | .098 | .118 | 2.50 | 3.00 |
| A3 | .000 | .010 | 0.00 | 0.25 |
| b | .035 | .047 | 0.90 | 1.20 |
| c | .028 | .035 | 0.70 | 0.90 |
| D | .551 | .591 | 14.00 | 15.00 |
| D1 | .512 | .539 | 13.00 | 13.70 |
| E | .394 | .433 | 10.00 | 11.00 |
| E1 | .331 | .346 | 8.40 | 8.80 |
| e | .200BSC | | 5.08 BSC | |
| L | .209 | .228 | 5.30 | 5.80 |
| L1 | .118 | .138 | 3.00 | 3.50 |
| L2 | .035 | .051 | 0.90 | 1.30 |
| L3 | .047 | .059 | 1.20 | 1.50 |
| L4 | .039 | .059 | 1.00 | 1.50 |