

K4N25 • K4N25A

These Photocouplers consist of a Gallium Arsenide Infrared Emitting Diode and a Silicon NPN Phototransistor in a 6-pin package.

FEATURES

- Switching Time - Typ. 3 μ s
- Collector-Emitter Voltage : Min.30V
- Current Transfer Ratio : Typ.100% (at IF=10mA, VCE=10V)
- Electrical Isolation Voltage : AC2500Vrms
- UL Recognized File No. E107486

APPLICATIONS

- Interface between two circuits of different potential
- Vending Machine, Voltage Regulator
- Traffic Controller System
- Programmable Controller

DIMENSION

(Unit : mm)

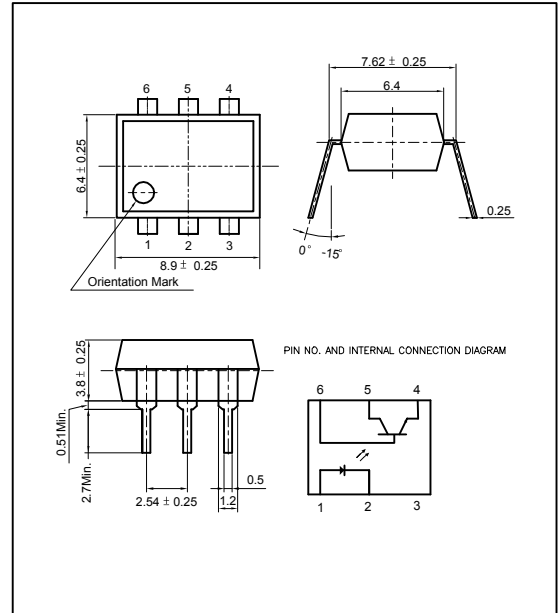

MAXIMUM RATINGS

(Ta=25)

Parameter		Symbol	Rating	Unit
Input	Forward Current	IF	80	mA
	Reverse Voltage	VR	5	V
	Peak Forward Current *1	IFP	3	A
	Power Dissipation	PD	70	mW
Output	Collector-Emitter Breakdown Voltage	BVCEO	35 *4	V
	Emitter-Collector Breakdown Voltage	BVECO	6	V
	Collector-Base Breakdown Voltage	BVECO	70	V
	Collector Current	IC	50	mA
	Collector Power Dissipation	PC	150	mW
Input to Output Isolation Voltage *2		Viso	AC2500	Vrms
Storage Temperature		Tstg	-55~+125	
Operating Temperature		Topr	-30~+100	
Lead Soldering Temperature *3		Tsol	260	
Total Power Dissipation		Ptot	200	mW

*1. Input current with 100 μ s pulse width, 1% duty cycle

*2. Measured at RH=40~60% for 1min

*3. 1/16 inch form case for 10sec

*4. Customer Option

K4N25 • K4N25A

ELECTRO-OPTICAL CHARACTERISTICS

(Ta=25°C , unless otherwise noted)

Parameter		Symbol	Condition	Min.	Typ.	Max.	Unit.
Input	Forward Voltage	V _F	I _F =10mA	-	1.15	1.30	V
	Reverse Current	I _R	V _R =5V	-	-	10	μA
	Capacitance	C _T	V=0, f=1MHz	-	30	-	pF
Output	Collector-Emitter Breakdown Voltage	BV _{CEO}	I _C =1mA	35	-	-	V
	Emitter-Collector Breakdown Voltage	BV _{ECO}	I _E =0.1mA	6	-	-	V
	Collector-Base Breakdown Voltage	BV _{CB0}	I _C =0.1mA	70	-	-	V
	Collector Dark Current	I _{CEO}	I _F =0, V _{CE} =10V	-	-	100	nA
	Capacitance	C _{CE}	V _{CE} =0, f=1MHz	-	10	-	pF
Coupled	Current Transfer Ratio ^{*5}	CTR	I _F =10mA, V _{CE} =10V	20	-	-	%
	Collector-Emitter Saturation Voltage	V _{CE(SAT)}	I _F =50mA, I _C =1mA	-	0.15	0.4	V
	Input-Output Capacitance	C _{IO}	V=0, f=1MHz	-	1	-	pF
	Input-Output Isolation Resistance	R _{IO}	RH=40~60%, V=500V	-	10 ¹¹	-	Ω
	Rise Time	t _r	V _{CE} =5V, R _L =100Ω	-	3	-	μs
	Fall Time	t _f	I _C =2mA	-	3	-	μs

*5. CTR=(I_C/I_F) X 100 (%)

K4N25 • K4N25A

Forward Current vs. Ambient Temperature

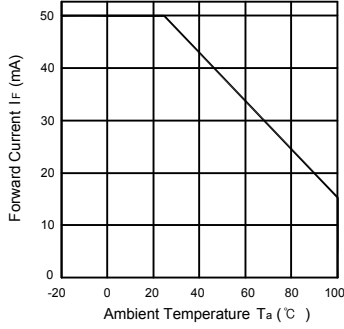

Collector Power Dissipation vs. Ambient Temperature

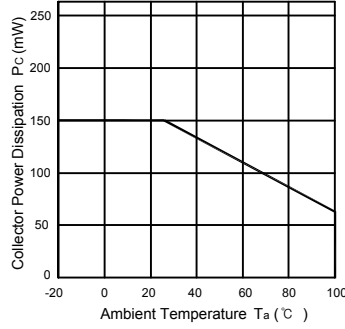

Forward Current vs. Forward Voltage

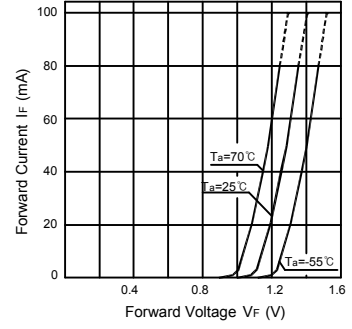

Collector Current vs. Collector-Emitter Voltage

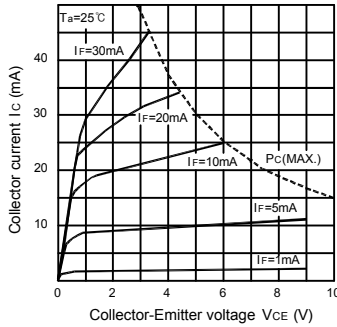

Dark Current vs. Ambient Temperature

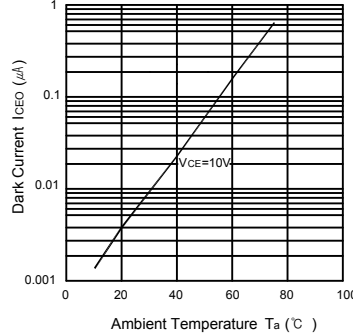

Collector Current vs. Ambient Temperature

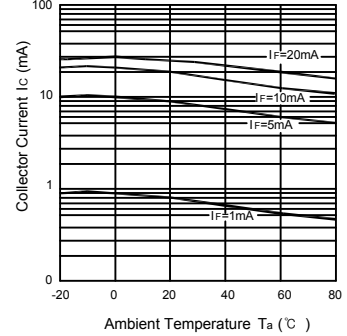

Response Time vs. Load Resistance

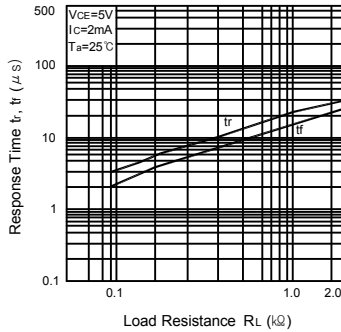

Collector Current vs. Forward Current

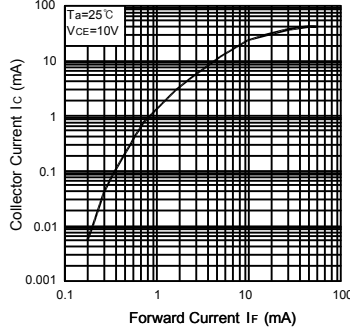

Switching Time Test Circuit

