

# KA1M0765R/KA1M0765RC

## Fairchild Power Switch(FPS)

### Features

- Precision fixed operating frequency (67kHz)
- Pulse by pulse current limiting
- Over load protection
- Over voltage protection (Min. 23V)
- Internal thermal shutdown function
- Under voltage lockout
- Internal high voltage sense FET
- Auto restart
- Soft start

### Description

The Fairchild Power Switch(FPS) product family is specially designed for an off line SMPS with minimal external components. The Fairchild Power Switch(FPS) consist of high voltage power SenseFET and current mode PWM controller IC. PWM controller features integrated fixed frequency oscillator, under voltage lock out, leading edge blanking, optimized gate turn-on/turn-off driver, thermal shutdown protection, over voltage protection, temperature compensated precision current sources for loop compensation and fault protection circuit. compared to discrete MOSFET and PWM controller or RCC solution, a Fairchild Power Switch(FPS) can reduce total component count, design size, weight and at the same time increase efficiency, productivity, and system reliability. It has a basic platform well suited for cost effective design in either a flyback converter or a forward converter.

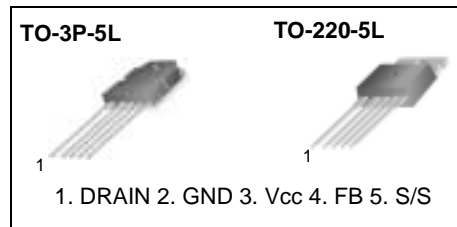

### Internal Block Diagram

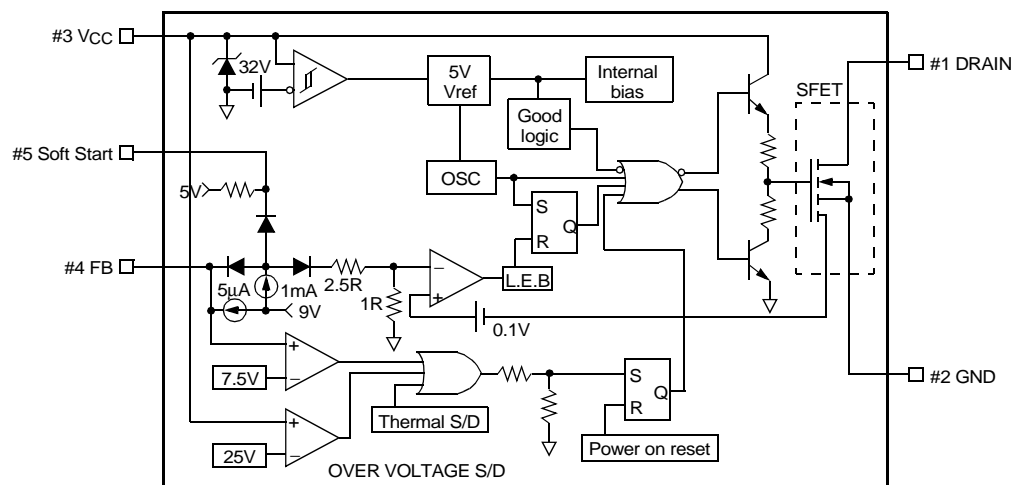

## Absolute Maximum Ratings

Characteristic	Symbol	Value	Unit
Maximum Drain voltage <sup>(1)</sup>	V <sub>D,MAX</sub>	650	V
Drain-Gate voltage (R <sub>GS</sub> =1MΩ)	V <sub>DGR</sub>	650	V
Gate-source (GND) voltage	V <sub>GS</sub>	±30	V
Drain current pulsed <sup>(2)</sup>	I <sub>DM</sub>	28.0	ADC
Single pulsed avalanche energy <sup>(3)</sup>	E <sub>AS</sub>	570	mJ
Continuous drain current (T <sub>C</sub> =25°C)	I <sub>D</sub>	7.0	ADC
Continuous drain current (T <sub>C</sub> =100°C)	I <sub>D</sub>	5.6	ADC
Maximum Supply voltage	V <sub>CC,MAX</sub>	30	V
Input voltage range	V <sub>FBI</sub>	-0.3 to V <sub>SD</sub>	V
Total power dissipation	P <sub>D</sub>	140	W
	Derating	1.11	W/°C
Operating ambient temperature	T <sub>A</sub>	-25 to +85	°C
Storage temperature	T <sub>STG</sub>	-55 to +150	°C

### Notes:

1. T<sub>j</sub>=25°C to 150°C
2. Repetitive rating: Pulse width limited by maximum junction temperature
3. L=24mH, V<sub>DD</sub>=50V, R<sub>G</sub>=25Ω, starting T<sub>j</sub>=25°C

## Electrical Characteristics (SFET part)

(Ta = 25°C unless otherwise specified)

Characteristic	Symbol	Test condition	Min.	Typ.	Max.	Unit
Drain-source breakdown voltage	BVDSS	VGS=0V, ID=50μA	650	-	-	V
Zero gate voltage drain current	IDSS	VDS=Max., Rating, VGS=0V	-	-	50	μA
		VDS=0.8Max., Rating, VGS=0V, TC=125°C	-	-	200	mA
Static drain-source on resistance <sup>(note)</sup>	RDS(ON)	VGS=10V, ID=4.0A	-	1.25	1.6	W
Forward transconductance <sup>(note)</sup>	gfs	VDS=15V, ID=4.0A	3.0	-	-	S
Input capacitance	Ciss	VGS=0V, VDS=25V, f=1MHz	-	1600	-	pF
Output capacitance	Coss		-	310	-	
Reverse transfer capacitance	Crss		-	120	-	
Turn on delay time	td(on)	VDD=0.5BVDSS, ID=7.0A (MOSFET switching time are essentially independent of operating temperature)	-	25	-	nS
Rise time	tr		-	55	-	
Turn off delay time	td(off)		-	80	-	
Fall time	tf		-	50	-	
Total gate charge (gate-source+gate-drain)	Qg	VGS=10V, ID=7.0A, VDS=0.5BVDSS (MOSFET switching time are essentially independent of operating temperature)	-	-	72	nC
Gate source charge	Qgs		-	9.3	-	
Gate drain (Miller) charge	Qgd		-	29.3	-	

**Note:**

Pulse test: Pulse width ≤ 300μS, duty ≤ 2%

$$S = \frac{1}{R}$$

## Electrical Characteristics (CONTROL part)

(Ta = 25°C unless otherwise specified)

Characteristic	Symbol	Test condition	Min.	Typ.	Max.	Unit
<b>UVLO SECTION</b>						
Start threshold voltage	VSTART	-	14	15	16	V
Stop threshold voltage	VSTOP	After turn on	9	10	11	V
<b>OSCILLATOR SECTION</b>						
Initial accuracy	FOSC	Ta=25°C	61	67	73	kHz
Frequency change with temperature <sup>(2)</sup>	$\Delta F/\Delta T$	-25°C ≤ Ta ≤ +85°C	-	±5	±10	%
Maximum duty cycle	Dmax	-	74	77	80	%
<b>FEEDBACK SECTION</b>						
Feedback source current	IFB	Ta=25°C, 0V ≤ Vfb ≤ 3V	0.7	0.9	1.1	mA
Shutdown Feedback voltage	VSD	-	6.9	7.5	8.1	V
Shutdown delay current	Idelay	Ta=25°C, 5V ≤ Vfb ≤ VSD	4.0	5.0	6.0	μA
<b>SOFT START SECTION</b>						
Soft Start Voltage	VSS	VFB =2V	4.7	5.0	5.3	V
Soft Start Current	ISS	Sync & S/S=GND	0.8	1.0	1.2	mA
<b>REFERENCE SECTION</b>						
Output voltage <sup>(1)</sup>	Vref	Ta = 25°C	4.80	5.00	5.20	V
Temperature Stability <sup>(1)(2)</sup>	Vref/ΔT	-25°C ≤ Ta ≤ +85°C	-	0.3	0.6	mV/°C
<b>CURRENT LIMIT (SELF-PROTECTION) SECTION</b>						
Peak Current Limit	I <sub>OVER</sub>	Max. inductor current	4.40	5.00	5.60	A
<b>PROTECTION SECTION</b>						
Thermal shutdown temperature (Tj) <sup>(1)</sup>	TSD	-	140	160	-	°C
Over voltage protection voltage	VOVP	-	23	25	28	V
<b>TOTAL DEVICE SECTION</b>						
Start Up current	I <sub>START</sub>	VCC=14V	0.1	0.3	0.4	mA
Operating supply current (control part only)	I <sub>OP</sub>	Ta=25°C	6	12	18	mA
VCC zener voltage	VZ	I <sub>CC</sub> =20mA	30	32.5	35	V

### Note:

1. These parameters, although guaranteed, are not 100% tested in production
2. These parameters, although guaranteed, are tested in EDS(water test) process
3. The amplitude of the sync. pulse is recommended to be between 2V and 3V for stable sync. function.

## Typical Performance Characteristics

(These characteristic graphs are normalized at  $T_a = 25^\circ\text{C}$ )

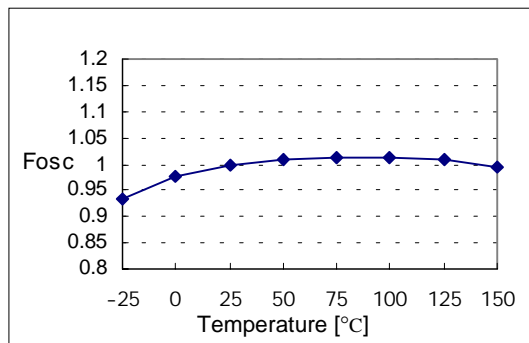

Figure 1. Operating Frequency

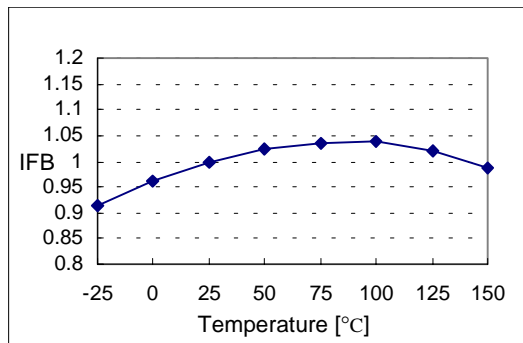

Figure 2. Feedback Source Current

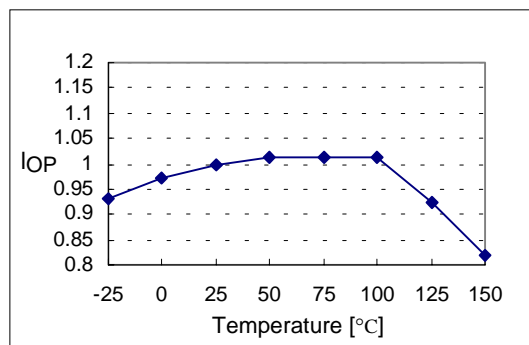

Figure 3. Operating Supply Current

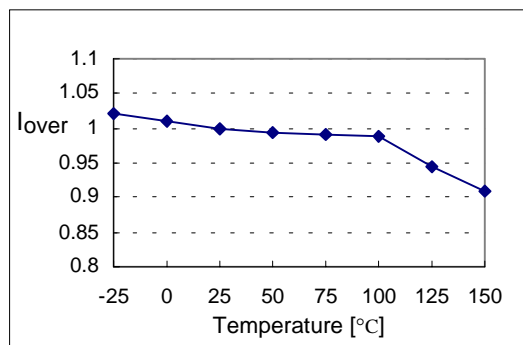

Figure 4. Peak Current Limit

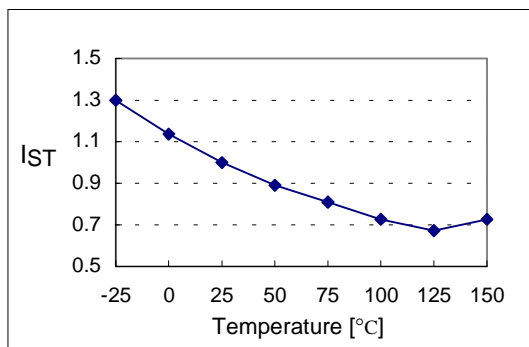

Figure 5. Start up Current

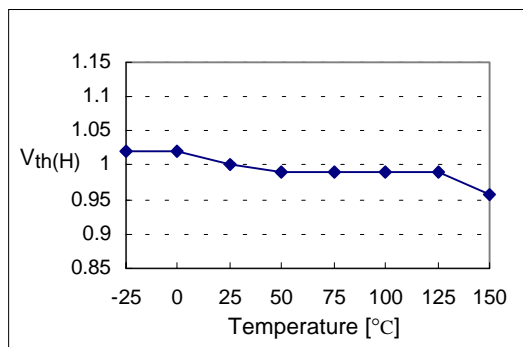

Figure 6. Start Threshold Voltage

## Typical Performance Characteristics (Continued)

(These characteristic graphs are normalized at  $T_a = 25^\circ\text{C}$ )

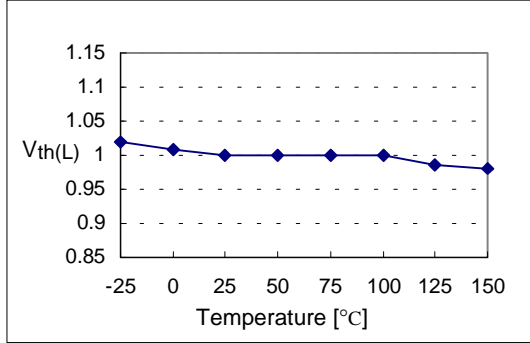

Figure 7. Stop Threshold Voltage



Figure 8. Maximum Duty Cycle



Figure 9. VCC Zener Voltage



Figure 10. Shutdown Feedback Voltage



Figure 11. Shutdown Delay Current



Figure 12. Over Voltage Protection

## Typical Performance Characteristics (Continued)

(These characteristic graphs are normalized at  $T_a = 25^\circ\text{C}$ )

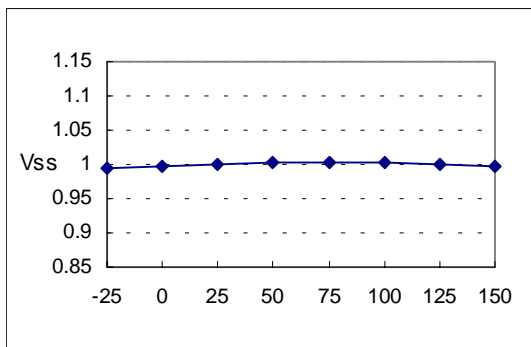

Figure13. Soft Start Voltage

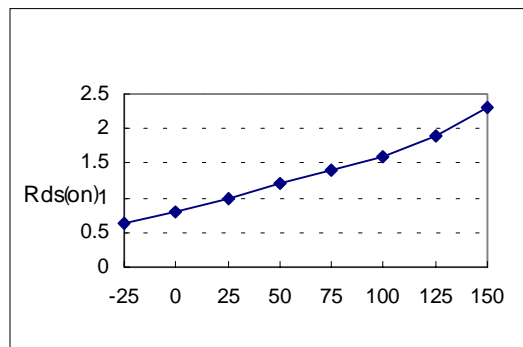

Figure 14. Static Drain-Source on Resistance





Package Dimensions (Continued)

TO-3P-5L (Forming)

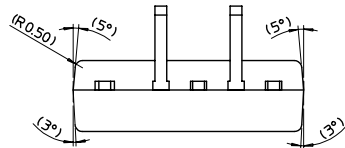
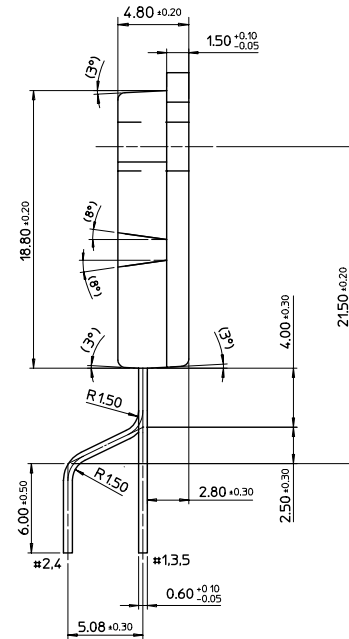
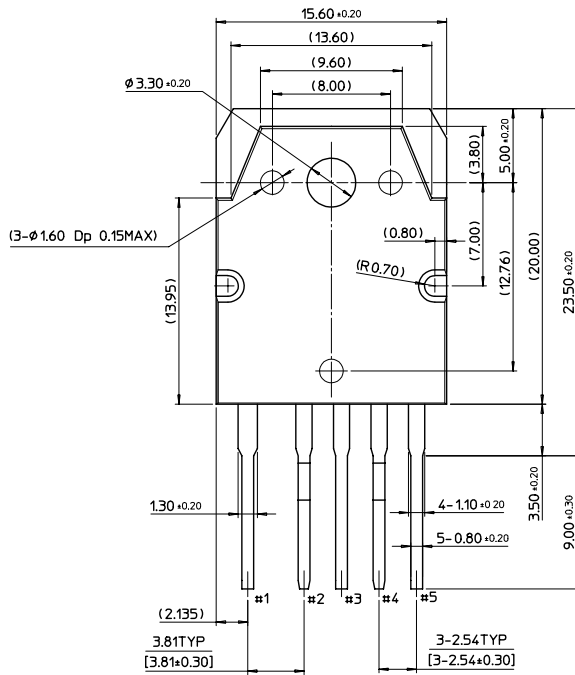

Package Dimensions (Continued)

TO-220-5L

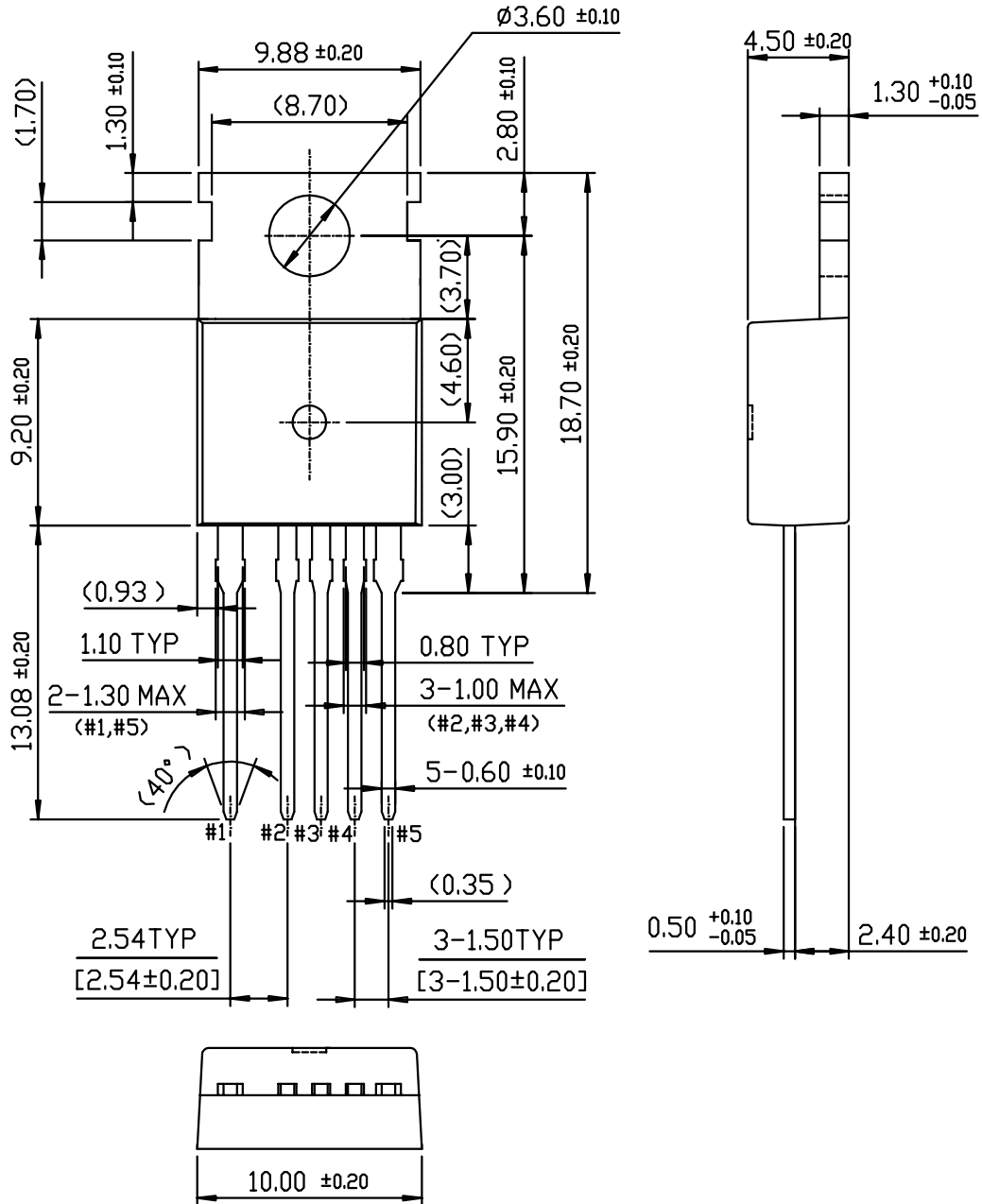

Package Dimensions (Continued)

TO-220-5L(Forming)

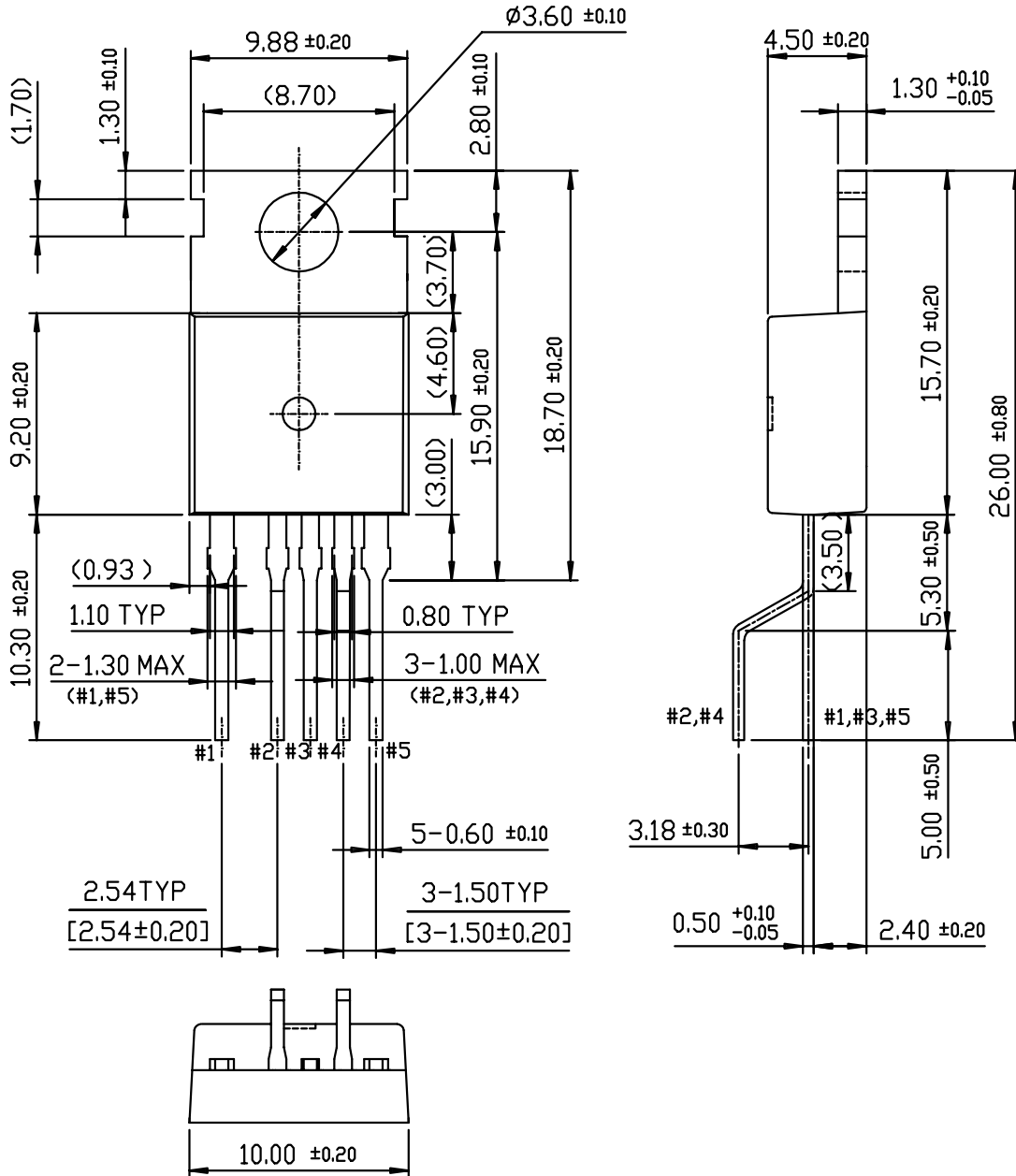

## Ordering Information

Product Number	Package	Rating	Fosc
KA1M0765R-TU	TO-3P-5L	650V, 7A	67kHz
KA1M0765R-YDTU	TO-3P-5L(Forming)		
KA1M0765RC-TU	TO-220-5L	650V, 7A	67kHz
KA1M0765RC-YDTU	TO-220-5L(Forming)		

TU : Non Forming Type

YDTU : Forming Type

### DISCLAIMER

FAIRCHILD SEMICONDUCTOR RESERVES THE RIGHT TO MAKE CHANGES WITHOUT FURTHER NOTICE TO ANY PRODUCTS HEREIN TO IMPROVE RELIABILITY, FUNCTION OR DESIGN. FAIRCHILD DOES NOT ASSUME ANY LIABILITY ARISING OUT OF THE APPLICATION OR USE OF ANY PRODUCT OR CIRCUIT DESCRIBED HEREIN; NEITHER DOES IT CONVEY ANY LICENSE UNDER ITS PATENT RIGHTS, NOR THE RIGHTS OF OTHERS.

### LIFE SUPPORT POLICY

FAIRCHILD'S PRODUCTS ARE NOT AUTHORIZED FOR USE AS CRITICAL COMPONENTS IN LIFE SUPPORT DEVICES OR SYSTEMS WITHOUT THE EXPRESS WRITTEN APPROVAL OF THE PRESIDENT OF FAIRCHILD SEMICONDUCTOR CORPORATION. As used herein:

1. Life support devices or systems are devices or systems which, (a) are intended for surgical implant into the body, or (b) support or sustain life, and (c) whose failure to perform when properly used in accordance with instructions for use provided in the labeling, can be reasonably expected to result in a significant injury of the user.
2. A critical component in any component of a life support device or system whose failure to perform can be reasonably expected to cause the failure of the life support device or system, or to affect its safety or effectiveness.