

KA2201

1.2W AUDIO POWER AMP

INTRODUCTION

The KA2201 is a monolithic integrated audio amplifier. It is designed for audio frequency class B amplifier.

FEATURES

- Wide operating supply voltage: $V_{CC} = 3V \sim 14V$
- Medium output power.
 $P_O = 1.2W$ at $V_{CC} = 9V$, $R_L = 8\Omega$, THD = 10%.
- Low quiescent circuit current ($I_{CCQ} = 4mA$: Typ).
- Good ripple rejection.
- Minimum number of external parts required.

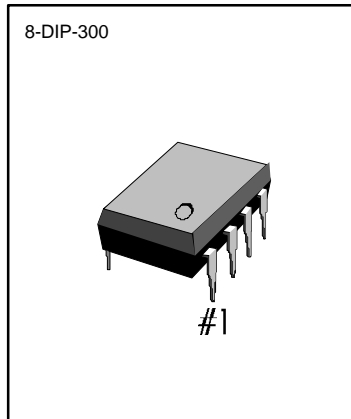

ORDERING INFORMATION

Device	Package	Operating Temperature
KA2201	8-DIP-300	-20°C ~ +70°C

BLOCK DIAGRAM

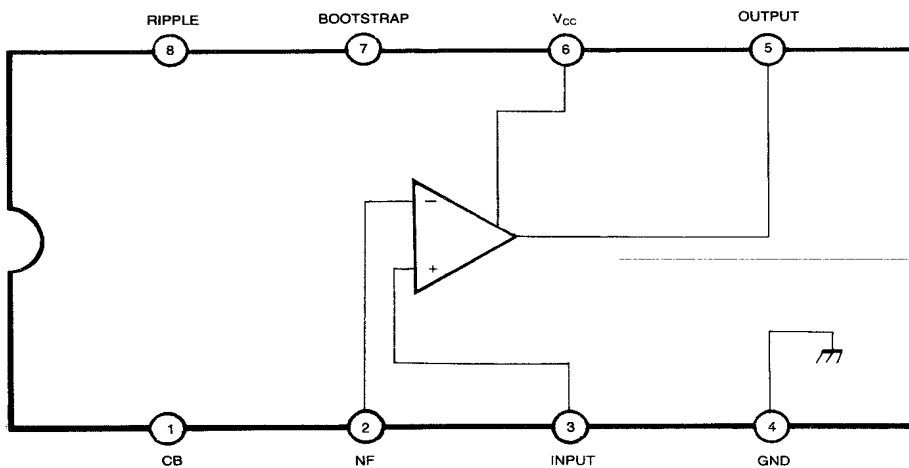

Fig. 1

ABSOLUTE MAXIMUM RATINGS

Characteristic	Symbol	value	Unit
Supply Voltage	V_{CC}	16	V
Output Peak Current	I_{PK}	1.5	A
Power Dissipation	P_D	1.25	W
Operating Temperature	T_{OPR}	- 20 ~ + 70	°C
Storage Temperature	T_{STG}	- 40 ~ + 150	°C

ELECTRICAL CHARACTERISTICS

($T_a = 25^\circ\text{C}$, $V_{CC} = 9\text{V}$, $f = 1\text{KHz}$, $R_G = 600\Omega$, $R_F = 120\Omega$, $R_L = 8\Omega$, unless otherwise specified)

Characteristic	Symbol	Test Conditions	Min	Typ	Max	Unit
Quiescent Circuit Current	I_{CCQ}	$V_i = 0$		4	12	mA
Output Power	P_O	$V_{CC} = 9\text{V}$, $R_L = 4\Omega$, THD = 10%	0.9	1.6		W
		$V_{CC} = 9\text{V}$, $R_L = 8\Omega$, THD = 10%		1.2		
		$V_{CC} = 6\text{V}$, $R_L = 4\Omega$, THD = 10%		0.75		
		$V_{CC} = 6\text{V}$, $R_L = 8\Omega$, THD = 10%	0.4	0.5		
		$V_{CC} = 12\text{V}$, $R_L = 8\Omega$, THD = 10%		2		
Total Harmonic Distortion	THD	$P_O = 500\text{mW}$		0.3	1.0	%
Open Loop Voltage Gain	G_{VO}	$R_F = 0$		75		dB
Closed Loop Voltage Gain	G_{VC}	$R_F = 120\Omega$	33	36	39	dB
Input Resistance	R_i			5		$M\Omega$
Output Noise Voltage	V_{NO}	$R_G = 10\text{K}\Omega$ BW (-3dB) = 50Hz-20KHz		0.3	1.0	mV

TEST CIRCUIT

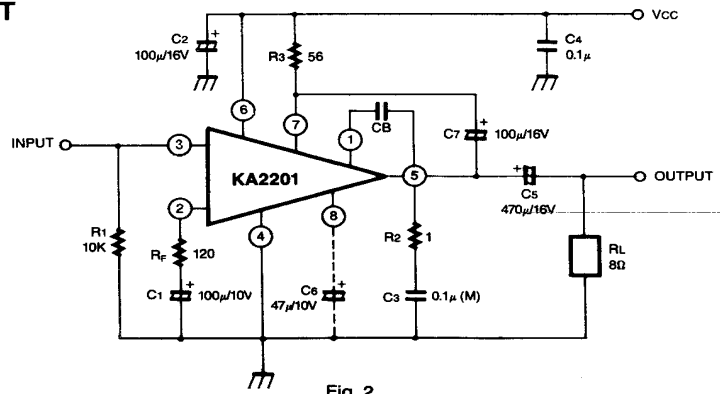
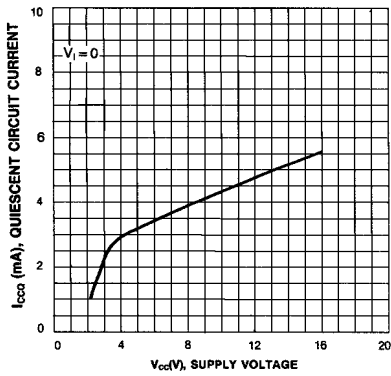
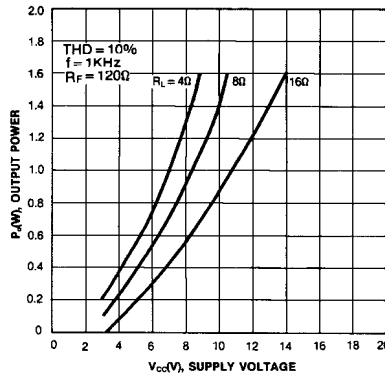

Fig. 2

QUIESCENT CIRCUIT CURRENT—SUPPLY VOLTAGE



OUTPUT POWER-SUPPLY VOLTAGE



FREQUENCY RESPONSE

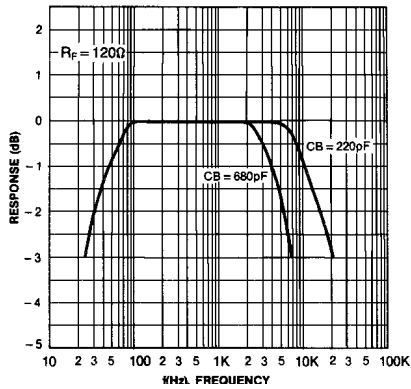

TOTAL HARMONIC DISTORTION-FREQUENCY

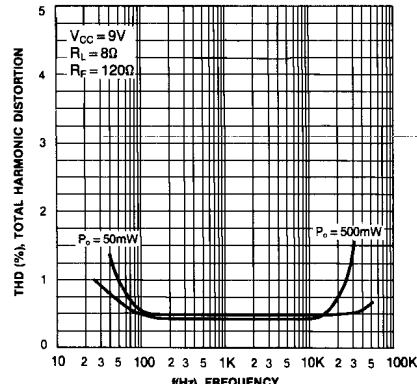

TOTAL HARMONIC DISTORTION-OUTPUT POWER

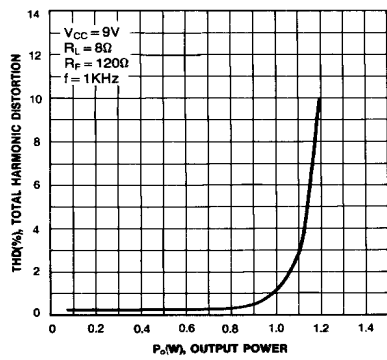

VOLTAGE GAIN-FEEDBACK RESISTANCE

