

Timing Circuit

KK555

The KK555 monolithic timing circuit is a highly stable controller capable of producing accurate time delays, or oscillation.

- Direct Replacement for NE555 Timers
- Timing From Microseconds Through Hours
- Operates in Both Astable and Monostable Modes
- High Current Output Can Source or Sink 200 mA

PIN ASSIGNMENT

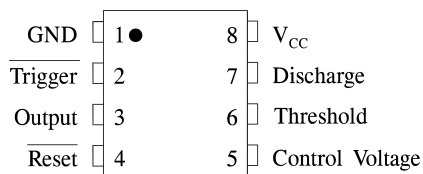

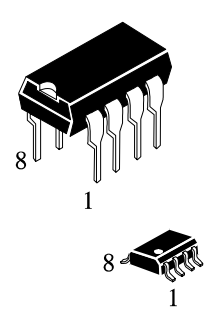

N SUFFIX
PLASTIC

D SUFFIX
SOIC

ORDERING INFORMATION
 KK555N Plastic
 KK555D SOIC
 T_A = -10° to 70° C for all packages

LOGIC DIAGRAM

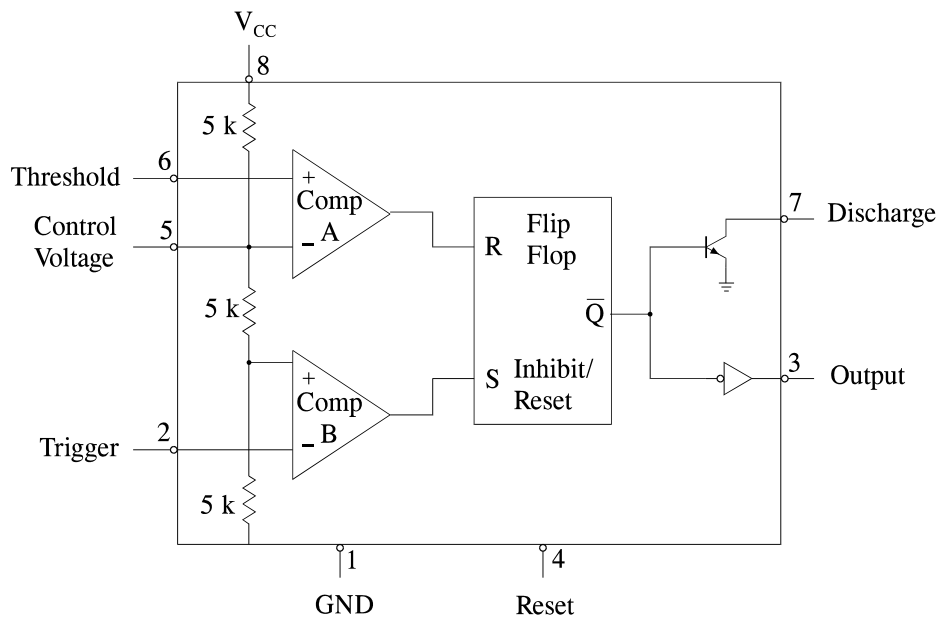

MAXIMUM RATINGS

Symbol	Parameter	Value	Unit
V _{CC}	Supply Voltage	18	V
T _{stg}	Storage Temperature	-60 to +85	°C

RECOMMENDED OPERATING CONDITIONS

Symbol	Parameter	Min	Max	Unit
V _{CC}	Supply Voltage	4.5	16	V
T _A	Operating Temperature, All Package Types	-10	+70	°C

ELECTRICAL CHARACTERISTICS(T_A =+25°C)

Symbol	Parameter	Test Conditions	Guaranteed Limits		Temperature, °C	Unit
			Min	Max		
V _{OH}	Output Voltage High	V _{CC} =5.0 V, V _{IL} =1.1 V V _{IH} =2.6 V, I _{OH} =100 mA	12.75		25±10 -10÷ +70	V
		V _{CC} =15 V, V _{IL} =4.5 V V _{IH} =9.0 V, I _{OH} =100 mA	2.75			
V _{OL}	Output Voltage Low	V _{CC} =5.0 V, V _{IL} =2.2 V V _{IH} =4.0 V, I _{IL} =5.0 mA		0.35		V
		V _{CC} =15 V, V _{IL} =5.6 V V _{IH} = 11 V, I _{OL} =10 mA		0.25		
		V _{CC} =15 V, V _{IL} =0 V V _{IH} =15 V, I _{OL} =50 mA		0.75		
		V _{CC} =15 V, V _{IL} =0 V V _{IH} =15 V, I _{OL} =100 mA		2.3		
V _{REF}	Reference voltage	V _{CC} =15 V, V _{IH} =11 V V _{IL} =0 V	9.0	11.0		V
		V _{CC} =5 V, V _{IH} =4 V V _{IL} =0 V	2.6	4.0		
I _{IL}	Low Level Input Current For pin 04 For pin 02	V _{CC} =15 V, V _{IH} =11 V V _{IL} =0 V				mA
				-0.4 -0.002		
I _I	Input Current	V _{CC} =15 V, V _{IH} =10 V V _{IL} =0 V		0.25	25±10	μA
				0.45	-10÷+70	
I _{CC}	Supply current	V _{CC} =5.0 V, V _{IL} =0 V V _{IH} =4.0 V		6.0	25±10 -10÷ +70	mA
		V _{CC} =15 V, V _{IL} =11 V V _{IL} =0 V		15		
t _{OLH}	Rise Time of Output	V _{CC} =15 V		150		ns
t _{OHL}	Fall Time of Output	V _{CC} =15 V		150		ns

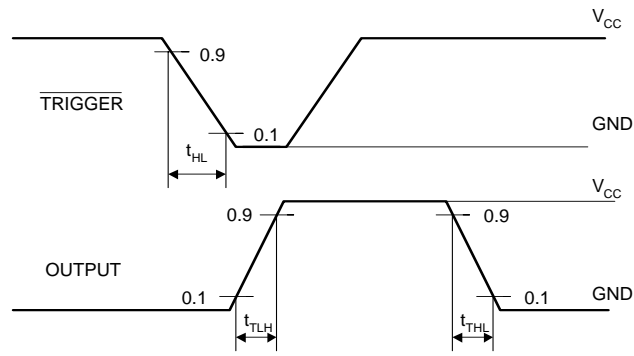
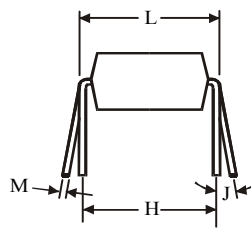
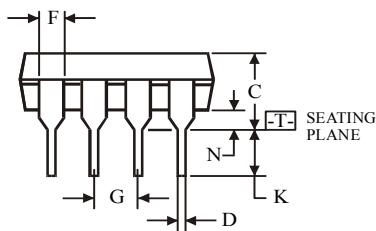
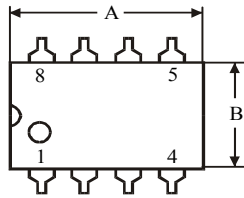
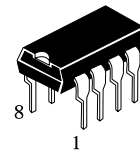

Figure 1. Switching Waveforms

N SUFFIX PLASTIC DIP (MS - 001BA)



⊕0.25 (0.010)Ⓜ T

Symbol	Dimension, mm	
	MIN	MAX
A	8.51	10.16
B	6.1	7.11
C		5.33
D	0.36	0.56
F	1.14	1.78
G	2.54	
H	7.62	
J	0°	10°
K	2.92	3.81
L	7.62	8.26
M	0.2	0.36
N	0.38	

NOTES:

- Dimensions "A", "B" do not include mold flash or protrusions.
Maximum mold flash or protrusions 0.25 mm (0.010) per side.

D SUFFIX SOIC (MS - 012AA)

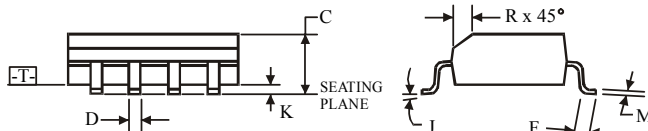
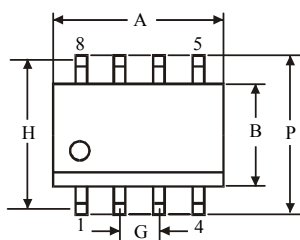
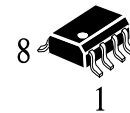

⊕0.25 (0.010)Ⓜ T CⓂ

Symbol	Dimension, mm	
	MIN	MAX
A	4.8	5
B	3.8	4
C	1.35	1.75
D	0.33	0.51
F	0.4	1.27
G	1.27	
H	5.72	
J	0°	8°
K	0.1	0.25
M	0.19	0.25
P	5.8	6.2
R	0.25	0.5

NOTES:

- Dimensions A and B do not include mold flash or protrusion.
- Maximum mold flash or protrusion 0.15 mm (0.006) per side for A; for B - 0.25 mm (0.010) per side.