

SANYO	No.2896	LA7220M
	3-Channel 2-Position Electronic Switch for VCR / Audio Use	

The LA7220M is a 3-channel 2-position high-performance analog switch having wide application from audio band to video band . It is also provided with 2 channels of muting function.

Features

- 3-channel 2-position switch
- Wide input dynamic range
- Low distortion
- Good frequency characteristic
- Muting available

Maximum Ratings at Ta = 25°C

Maximum Supply Voltage	V _{CC} max		15	V
Allowable Power Dissipation	P _d max	Ta ≤ 65°C	500	mW
Operating Temperature	T _{op}		- 20 to + 65	°C
Storage Temperature	T _{stg}		- 40 to + 125	°C

Operating Conditions at Ta = 25°C

Recommended Supply Voltage	V _{CC}	12	V
Operating Voltage Range	V _{CC} op	9 to 13	V

Equivalent Circuit Block Diagram

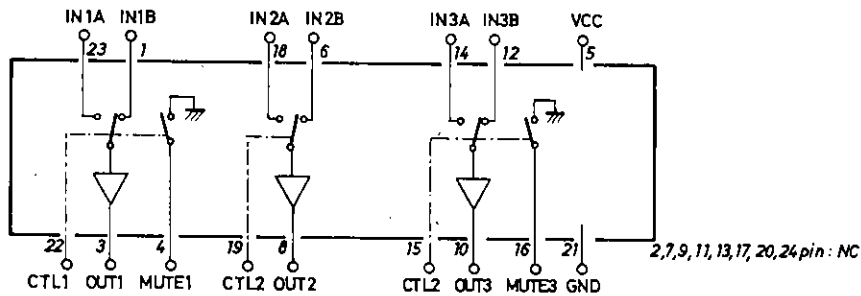

Package Dimensions

(unit : mm)

3045B

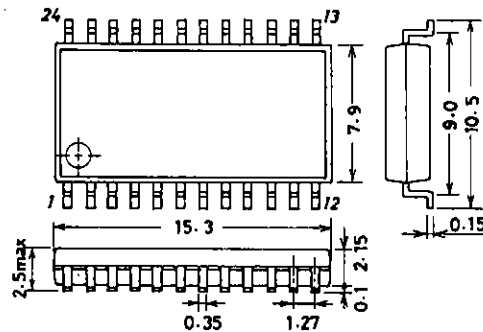

SANYO : MFP24

LA7220M

Operating Characteristics at Ta = 25°C, VCC = 12V				min	typ	max	unit
Current Dissipation	I _{CC}				30.0	39.9	mA
Total Harmonic Distortion	THD	*1, R _g = 600Ω, 4.5V _{p-p} , f = 1kHz R _L = ∞			0.007	0.1	%
Noise Voltage	V _{NO}	*1, R _g = 600Ω, f = 20Hz to 20kHz R _L = ∞			-93	-80	dBs
Crosstalk 1ch	CR1	*2, Input 1: R _g = 50Ω, 2V _{p-p} , f = 3.58MHz, Input 2: R _g = 500Ω			-50		dB
2ch	CR2	*2, Input 1: R _g = 50Ω			-60		dB
3ch	CR3	*2, Input 1: R _g = 50Ω			-50		dB
Pedestal Level	ΔV _{ped}	*1, V _{CTL} (Pins 10, 13, 15) = 0 to 12V		-100	0	+100	mV
Maximum Input Voltage	vinmax	*1, R _g = 600Ω, f = 1kHz, R _L = ∞, THD = 1%		5.0			V _{p-p}
2nd Harmonic Voltage	H2	*1, R _g = 50Ω, 4.0V _{p-p} , f = 1MHz, R _L = ∞		-46	-55		dB
3rd Harmonic Voltage	H3	*1, "		-46	-55		dB
Switch Changeover Voltage	V _{CTLs}	*1		2.6	3.1	4.0	V
Mute Threshold Voltage	V _{ML}	*3, L Level, mute threshold voltage		1.1	1.5	1.9	V
	V _{MH}	*3, H Level, mute threshold voltage		6.6	7.3	8.0	V
Crosstalk between Channels							
1ch		*4, R _g = 500Ω, R _L = ∞, other channel input R _g = 50Ω, 2V _{p-p} , f = 3.58MHz		-50	-68		dB
2ch		*4, "		-50	-68		dB
3ch		*4, "		-50	-68		dB
Mute Compression Ratio		*3, R _g = 600Ω, 2V _{p-p} , f = 1kHz, R _L = ∞, series resistance 10kΩ			-60		dB
Control Pin Flow-in Current	I _{CTL}	*1				8	μA
Input Impedance	z _{in}	*1				10	kΩ
Output Impedance	z _{out}	*1				29	Ω
Pin Voltage	(Pin 1)	V1	V22 = 0V			7.9	V
"	(Pin 1)	V1	V22 = 12V			7.9	V
"	(Pin 3)	V3				7.2	V
"	(Pin 6)	V6	V19 = 0V			7.9	V
"	(Pin 6)	V6	V19 = 12V			7.9	V
"	(Pin 8)	V8				7.2	V
"	(Pin 10)	V10				7.2	V
"	(Pin 12)	V12	V15 = 0V			7.9	V
"	(Pin 12)	V12	V15 = 12V			7.9	V
"	(Pin 14)	V14	V15 = 0V			7.9	V
"	(Pin 14)	V14	V15 = 12V			7.9	V
"	(Pin 18)	V18	V19 = 0V			7.9	V
"	(Pin 18)	V18	V19 = 12V			7.9	V
"	(Pin 23)	V23	V22 = 0V			7.9	V
"	(Pin 23)	V23	V22 = 12V			7.9	V

*1 Measurements are made for each of 1ch, 2ch, 3ch using input A and input B.

Input A : V_{CTL}(pins 10, 13, 15) is 12V at the measurement mode.

Input B : V_{CTL} is 0V at the measurement mode.

*2 Measurements are made using input A and input B.

*3 Measurements are made for 1ch, 3ch.

*4 Measurements are made for each of 1ch, 2ch, 3ch using input A and input B on other channel.

LA7220M

Test Circuit

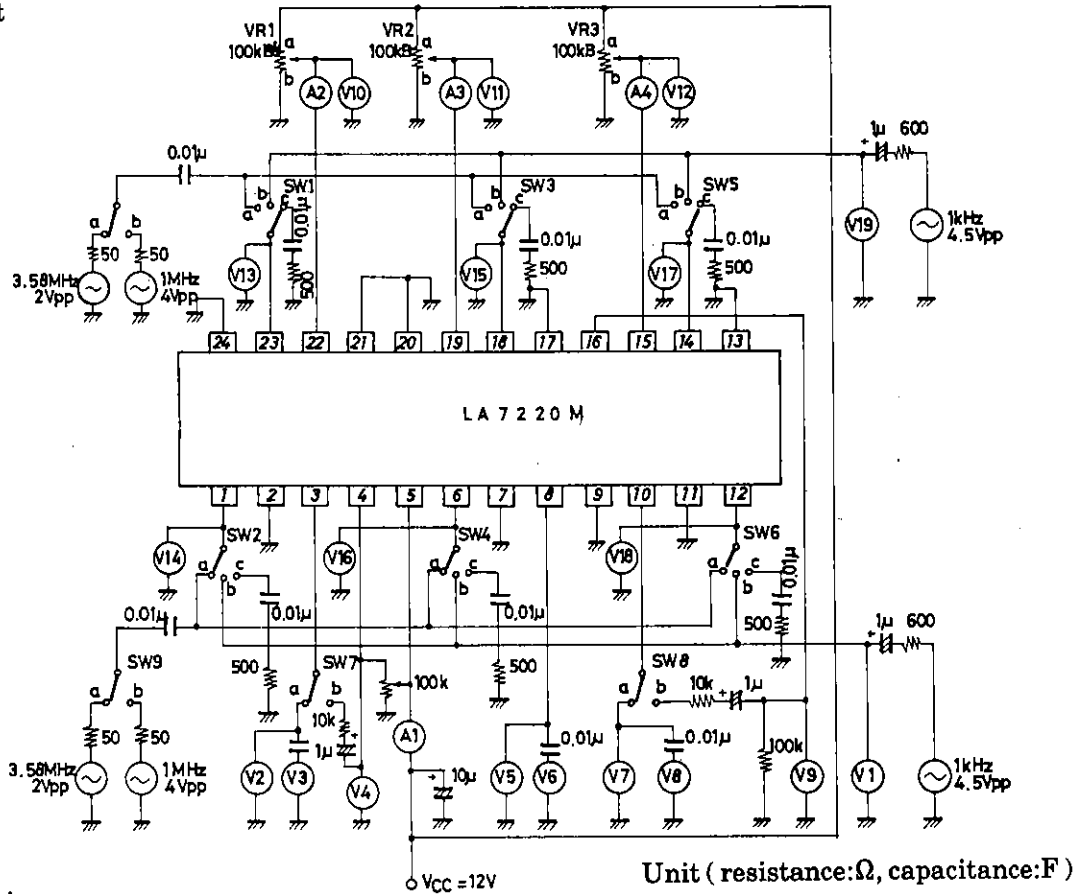

Test Conditions

Item	Symbol	SW VR Mode											Test Point		
		SW1	SW2	SW3	SW4	SW5	SW6	SW7	SW8	SW9	VR1	VR2		VR3	
Current Dissipation	I _{CC}	c	c	c	c	c	c	c	a	a	a	b	b	b	A1
Total Harmonic Distortion	1 chA	THD	b	c	c	c	c	c	a	a	a	a	b	b	V3
	1 chB	THD	c	b	c	c	c	c	a	a	a	b	b	b	V3
	2 chA	THD	c	c	b	c	c	c	a	a	a	b	a	b	V6
	2 chB	THD	c	c	c	b	c	c	a	a	a	b	b	b	V6
	3 chA	THD	c	c	c	c	b	c	a	a	a	b	b	a	V8
	3 chB	THD	c	c	c	c	c	b	a	a	a	b	b	b	V8
Noise	1 chA	V _{N0}	c	c	c	c	c	c	a	a	a	a	b	b	V3
	1 chB	V _{N0}	c	c	c	c	c	c	a	a	a	b	b	b	V3
	2 chA	V _{N0}	c	c	c	c	c	c	a	a	a	b	a	b	V6
	2 chB	V _{N0}	c	c	c	c	c	c	a	a	a	b	b	b	V6
	3 chA	V _{N0}	c	c	c	c	c	c	a	a	a	b	b	a	V8
	3 chB	V _{N0}	c	c	c	c	c	c	a	a	a	b	b	b	V8
Crosstalk	1 chA	CR1	c	a	c	c	c	c	a	a	a	a	b	b	V3
	1 chB	CR1	a	c	c	c	c	c	a	a	a	b	b	b	V3
	2 chA	CR2	c	c	c	a	c	c	a	a	a	b	a	b	V6
	2 chB	CR2	c	c	a	c	c	c	a	a	a	b	b	b	V6
	3 chA	CR3	c	c	c	c	c	a	a	a	a	b	b	a	V8
	3 chB	CR3	c	c	c	c	a	c	a	a	a	b	b	b	V8
Pedestal	1 ch	ΔV _{PED}	c	c	c	c	c	c	a	a	a	a/b	b	b	V2
	2 ch	ΔV _{PED}	c	c	c	c	c	c	a	a	a	b	a/b	b	V5
	3 ch	ΔV _{PED}	c	c	c	c	c	c	a	a	a	b	b	a/b	V7
Maximum Input Voltage	1 chA	V _{inmax}	b	c	c	c	c	c	a	a	a	a	b	b	V19
	1 chB	V _{inmax}	c	b	c	c	c	c	a	a	a	b	b	b	V1
	2 chA	V _{inmax}	c	c	b	c	c	c	a	a	a	b	a	b	V19
	2 chB	V _{inmax}	c	c	c	b	c	c	a	a	a	b	b	b	V1
	3 chA	V _{inmax}	c	c	c	c	b	c	a	a	a	b	b	a	V19
	3 chB	V _{inmax}	c	c	c	c	c	b	a	a	a	b	b	b	V1

LA7220M

Item	Symbol	SW VR Mode												Test	
		SW1	SW2	SW3	SW4	SW5	SW6	SW7	SW8	SW9	VR1	VR2	VR3	Point	
2nd Harmonic	1 chA	H2-1	a	c	c	c	c	c	a	a	b	a	b	b	V3
	1 chB	H2-1	c	a	c	c	c	c	a	a	b	b	b	b	V3
	2 chA	H2-2	c	c	a	c	c	c	a	a	b	b	a	b	V6
	2 chB	H2-2	c	c	c	a	c	c	a	a	b	b	b	b	V6
	3 chA	H2-3	c	c	c	c	a	c	a	a	b	b	b	a	V8
	3 chB	H2-3	c	c	c	c	c	a	a	a	b	b	b	b	V8
3rd Harmonic	1 chA	H3-1	a	c	c	c	c	c	a	a	b	a	b	b	V3
	1 chB	H3-1	c	a	c	c	c	c	a	a	b	b	b	b	V3
	2 chA	H3-2	c	c	a	c	c	c	a	a	b	b	a	b	V6
	2 chB	H3-2	c	c	c	a	c	c	a	a	b	b	b	b	V6
	3 chA	H3-3	c	c	c	c	a	c	a	a	b	b	b	a	V8
	3 chB	H3-3	c	c	c	c	c	a	a	a	b	b	b	b	V8
Switch Changeover Voltage	1 ch	VCTLS	a	a	c	c	c	c	a	a	a	Var*	b	b	V10
	2 ch	VCTLS	c	c	a	a	c	c	a	a	a	b	Var*	b	V11
	3 ch	VCTLS	c	c	c	c	a	a	a	a	a	b	b	Var*	V12
Mute Threshold	1 ch	VML	b	b	c	c	c	c	b	a	a	Var*	b	b	V10
	1 ch	VMH	b	b	c	c	c	c	b	a	a	Var*	b	b	V10
	3 ch	VML	c	c	c	c	b	b	a	b	a	b	b	Var*	V12
	3 ch	VMH	c	c	c	c	b	b	a	b	a	b	b	Var*	V12
Crosstalk between Channels	1 ch		c	c	c	c	a	c	a	a	a	a	a	a	V3
	1 ch		c	c	c	c	c	a	a	a	a	a	a	b	V3
	1 ch		c	c	c	c	a	c	a	a	a	a	b	a	V3
	1 ch		c	c	c	c	c	c	a	a	a	a	b	a	V3
	1 ch		c	c	a	c	c	c	a	a	a	b	a	b	V3
	1 ch		c	c	c	a	c	c	a	a	a	b	b	a	V3
	1 ch		c	c	c	a	c	c	a	a	a	b	b	b	V3
	1 ch		c	c	c	a	c	c	a	a	a	b	b	b	V3
	2 ch		c	c	c	c	a	c	a	a	a	a	a	a	V6
	2 ch		c	c	c	c	c	a	a	a	a	a	a	b	V6
	2 ch		c	c	c	c	a	c	a	a	a	b	a	a	V6
	2 ch		c	c	c	c	c	a	a	a	a	a	b	a	V6
	2 ch		a	c	c	c	c	c	a	a	a	a	b	a	V6
	2 ch		a	c	c	c	c	c	a	a	a	a	b	b	V6
	2 ch		c	a	c	c	c	c	a	a	a	b	b	a	V6
	2 ch		c	a	c	c	c	c	a	a	a	b	b	b	V6
	3 ch		c	c	a	c	c	c	a	a	a	a	a	a	V8
	3 ch		c	c	c	a	c	c	a	a	a	a	b	a	V8
	3 ch		c	c	c	a	c	c	a	a	a	b	b	a	V8
	3 ch		a	c	c	c	c	c	a	a	a	a	a	b	V8
3 ch		c	a	c	c	c	c	a	a	a	b	a	b	V8	
3 ch		c	a	c	c	c	c	a	a	a	b	b	b	V8	
Mute Compression Ratio	1 ch		b	b	c	c	c	c	b	a	a	Var*	b	b	V4
	3 ch		c	c	c	c	b	b	a	b	a	b	b	Var*	V9
Control Pin Flow-in Current	1 ch	I CTL1	c	c	c	c	c	c	a	a	a	a	b	b	A2
	2 ch	I CTL2	c	c	c	c	c	c	a	a	a	b	a	b	A3
	3 ch	I CTL3	c	c	c	c	c	c	a	a	a	b	b	a	A4
Pin Voltage	(Pin 1)	V1	c	c	c	c	c	c	a	a	a	b	b	b	V14
	(Pin 1)	V1	c	c	c	c	c	c	a	a	a	a	b	b	V14
	(Pin 3)	V3	c	c	c	c	c	c	a	a	a	b	b	b	V2
	(Pin 6)	V6	c	c	c	c	c	c	a	a	a	b	b	b	V16
	(Pin 6)	V6	c	c	c	c	c	c	a	a	a	b	a	b	V16
	(Pin 8)	V8	c	c	c	c	c	c	a	a	a	b	b	b	V5
	(Pin 10)	V10	c	c	c	c	c	c	a	a	a	b	b	b	V7

LA7220M

Item	Symbol	SW VR Mode												Test Point
		SW1	SW2	SW3	SW4	SW5	SW6	SW7	SW8	SW9	VR1	VR2	VR3	
(Pin 12)	V 12	c	c	c	c	c	c	a	a	a	b	b	b	V18
(Pin 12)	V 12	c	c	c	c	c	c	a	a	a	b	b	a	V18
(Pin 14)	V 14	c	c	c	c	c	c	a	a	a	b	b	b	V17
(Pin 14)	V 14	c	c	c	c	c	c	a	a	a	b	b	a	V17
(Pin 18)	V 18	c	c	c	c	c	c	a	a	a	b	b	b	V15
(Pin 18)	V 18	c	c	c	c	c	c	a	a	a	b	a	b	V15
(Pin 23)	V 23	c	c	c	c	c	c	a	a	a	b	b	b	V13
(Pin 23)	V 23	c	c	c	c	c	c	a	a	a	a	b	b	V13

(Note) Var* : While monitoring pins 3, 8, 10, adjust so that the minimum output is obtained.
 Mute Threshold : While monitoring pins 4, 16, measure the minimum and maximum values of V15, V18 when the minimum output is obtained.

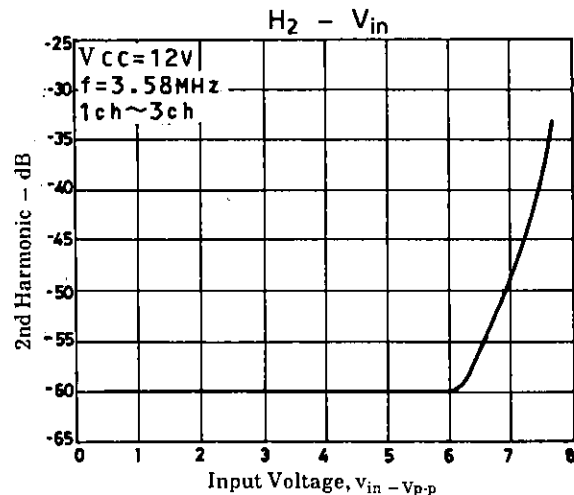
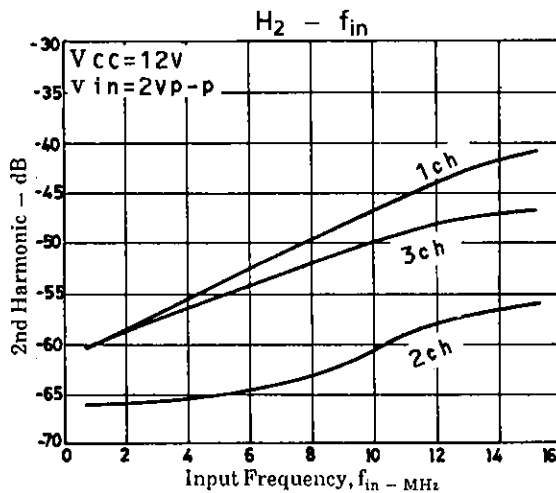
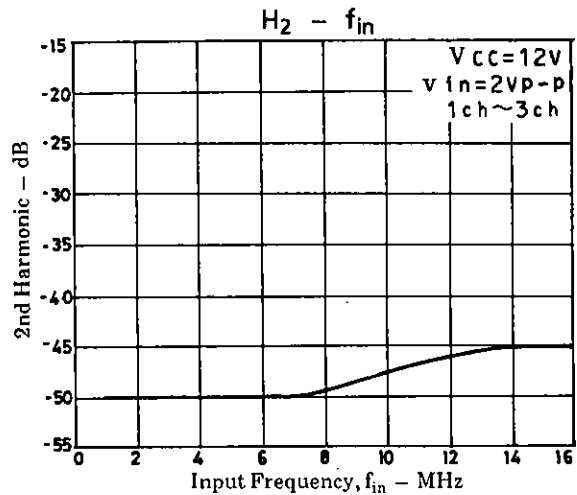
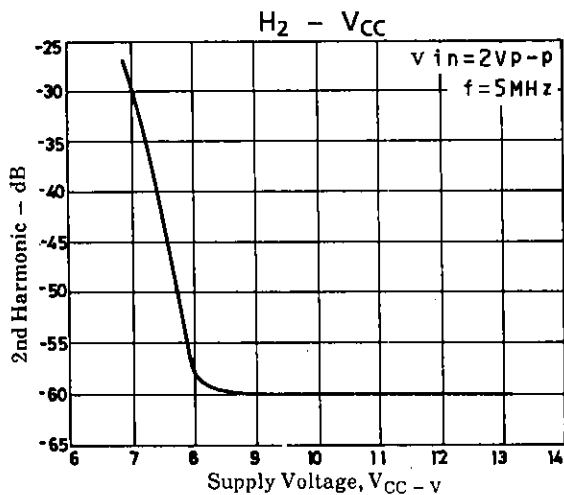

■ No products described or contained herein are intended for use in surgical implants, life-support systems, aerospace equipment, nuclear power control systems, vehicles, disaster/crime-prevention equipment and the like, the failure of which may directly or indirectly cause injury, death or property loss.

■ Anyone purchasing any products described or contained herein for an above-mentioned use shall:

- ① Accept full responsibility and indemnify and defend SANYO ELECTRIC CO., LTD., its affiliates, subsidiaries and distributors and all their officers and employees, jointly and severally, against any and all claims and litigation and all damages, cost and expenses associated with such use;
- ② Not impose any responsibility for any fault or negligence which may be cited in any such claim or litigation on SANYO ELECTRIC CO., LTD., its affiliates, subsidiaries and distributors or any of their officers and employees jointly or severally.

■ Information (including circuit diagrams and circuit parameters) herein is for example only; it is not guaranteed for volume production. SANYO believes information herein is accurate and reliable, but no guarantees are made or implied regarding its use or any infringements of intellectual property rights or other rights of third parties.

This catalog provides information as of **December, 1996**. Specifications and information herein are subject to change without notice.