

SANYO

No.3352B

LA7954**Video Switch for TV / VCR Use****Features**

- 4 inputs, 1 output
- Excellent crosstalk characteristic
- Wide band

Maximum Ratings at Ta = 25°C

			unit
Maximum Supply Voltage	V7 max		14 V
Maximum Input Apply Voltage (1)	V4 max, V6 max V8 max, V9 max,		8 V
Maximum Input Apply Voltage (2)	V2 max, V3 max	V _{CC} = 14V	14 V
Maximum Output Current	I1 max		7 mA
Allowable Power Dissipation	Pd max	Ta ≤ 65°C	540 mW
Operating Temperature	Topr		-20 to +65 °C
Storage Temperature	Tstg		-55 to +150 °C

Operating Conditions at Ta = 25°C

			unit
Operating Voltage Range	V _{CC} op		8 to 13.5 V
Recommended Supply Voltage	V _{CC}		12 V

Operating Characteristics at Ta = 25°C, V_{CC} = 12V

		min	typ	max	unit
Quiescent Current	I _{CC}	9	12	17	mA
Input Bias Voltage	V4, V6, V8, V9	4.5	4.8	5.1	V
Output Bias Voltage	V1	3.7	4.1	4.3	V
Output DC Offset Voltage	V _{OS}	-50	0	+50	mV
Control Threshold Voltage	V2H, V3H, V2L, V3L	2.3		0.7	V

Continued on next page.

Package Dimensions

(unit : mm)

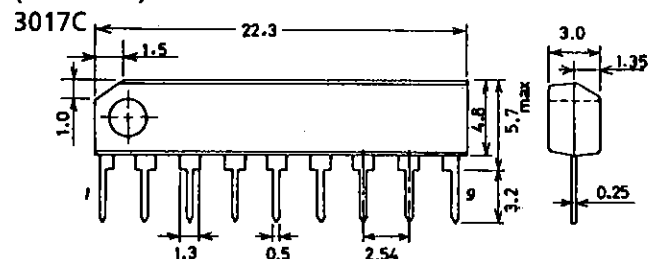

SANYO : SIP9

SANYO Electric Co., Ltd. Semiconductor Business Headquarters
 TOKYO OFFICE Tokyo Bldg., 1-10, 1 Chome, Ueno, Taito-ku, TOKYO, 110 JAPAN

O3095MH/D121TH/3260TA, TS No.3352-1/4

Continued from preceding page.

			min	typ	max	unit
Control Input Current	I ₂ , I ₃		-20	-6		μA
Voltage Gain	GV	f = 1MHz, V _{IN} = 2V _{pp} (Note 1)	-0.5	-0.2		dB
Frequency Characteristic	GV-f	[0dB at f = 100kHz (Note 1) f = 10MHz, V _{IN} = 2V _{pp}	-3	0		dB
Output Dynamic Range	V _{DR}	f = 15kHz, V _{IN} = 6p-p (Note 1)		0.3	6	%
Crosstalk (Note 2)	CT	V _{IN} = 2V _{p-p} , f = 3MHz (Note 1)	48	58		dB
		V _{IN} = 2V _{p-p} , f = 5MHz (Note 1)	45	55		dB

※ Current flowing into the IC is defined as positive; current flowing out is defined as negative.

Video Switch Truth Table

S2 (Pin 2)	S3 (Pin 3)	V _{IN1} (Pin 4)	V _{IN2} (Pin 6)	V _{IN3} (Pin 8)	V _{IN4} (Pin 9)
H	H	ON	OFF	OFF	OFF
L	H	OFF	ON	OFF	OFF
H	L	OFF	OFF	ON	OFF
L	L	OFF	OFF	OFF	ON

Note 1 : Refer to this Truth Table and make measurements by switching S2, S3.

Input/Output Equivalent Circuit

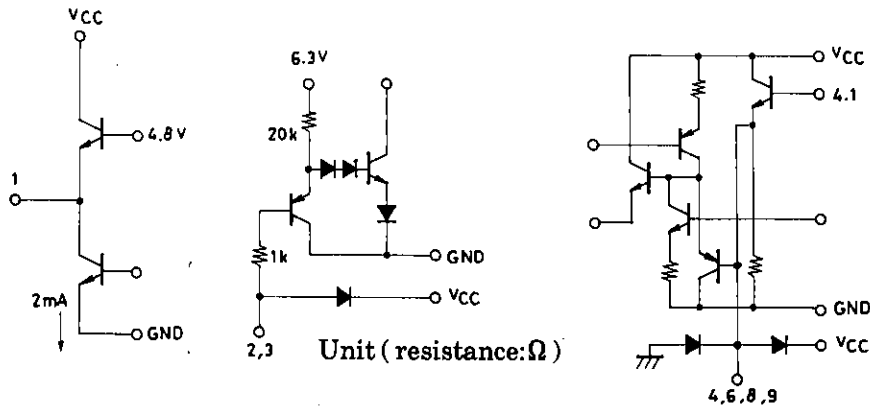

Equivalent Circuit Block Diagram

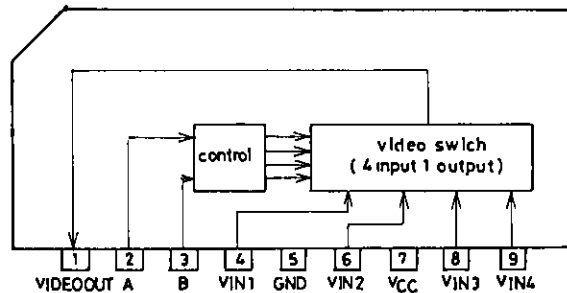

Test Circuit

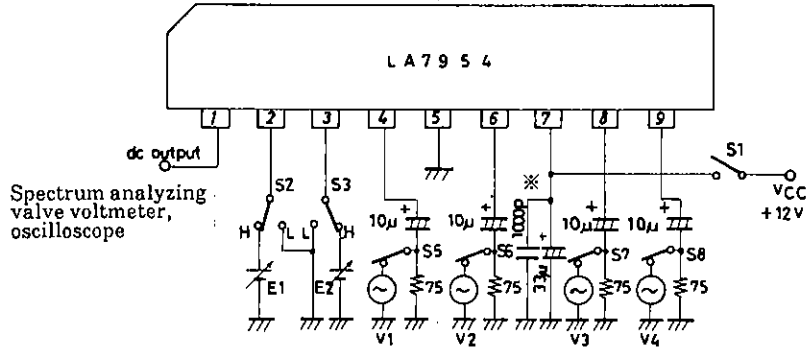

※ : Connect the bypass capacitor for V_{CC} as close to pin 7 as possible.

Unit (resistance:Ω, capacitance:F)

Input/Output Characteristic

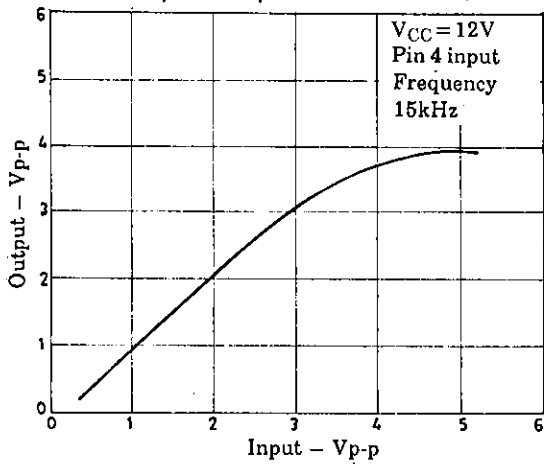

CT - f

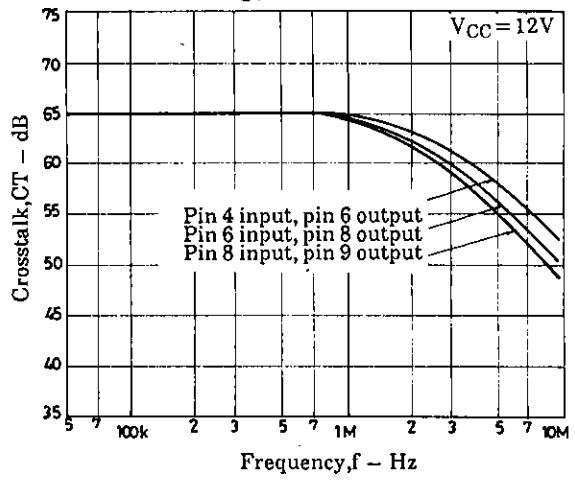

Frequency Characteristic

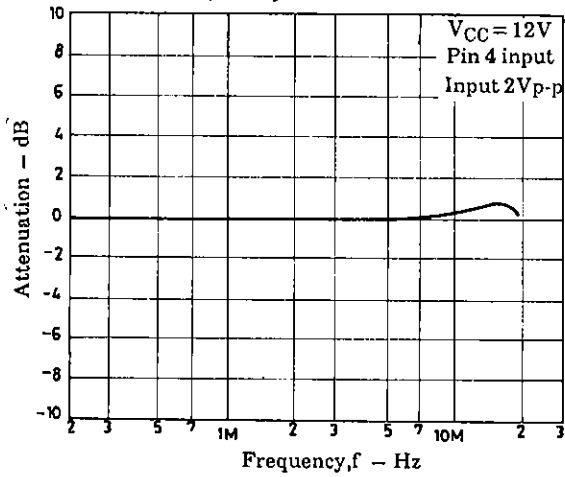

- No products described or contained herein are intended for use in surgical implants, life-support systems, aerospace equipment, nuclear power control systems, vehicles, disaster/crime-prevention equipment and the like, the failure of which may directly or indirectly cause injury, death or property loss.
- Anyone purchasing any products described or contained herein for an above-mentioned use shall:
 - ① Accept full responsibility and indemnify and defend SANYO ELECTRIC CO., LTD., its affiliates, subsidiaries and distributors and all their officers and employees, jointly and severally, against any and all claims and litigation and all damages, cost and expenses associated with such use;
 - ② Not impose any responsibility for any fault or negligence which may be cited in any such claim or litigation on SANYO ELECTRIC CO., LTD., its affiliates, subsidiaries and distributors or any of their officers and employees jointly or severally.
- Information (including circuit diagrams and circuit parameters) herein is for example only; it is not guaranteed for volume production. SANYO believes information herein is accurate and reliable, but no guarantees are made or implied regarding its use or any infringements of intellectual property rights or other rights of third parties.

This catalog provides information as of **December, 1996**. Specifications and information herein are subject to change without notice.