

## APPLICATIONS

- ✓ Ethernet - 10/100 Base T
- ✓ RS-458
- ✓ xDSL & ATM
- ✓ SCSI & USB
- ✓ Audio/Video I/O Ports

## IEC COMPATIBILITY (EN61000-4)

- ✓ 61000-4-2 (ESD): Air - 15kV, Contact - 8kV
- ✓ 61000-4-4 (EFT): 40A - 5/50ns
- ✓ 61000-4-5 (Surge): 24A, 8/20 $\mu$ s Level 2 (Line-Ground) & Level 3 (Line-Line)

## FEATURES

- ✓ 800 Watts Peak Pulse Power per Line ( $t_p=8/20\mu$ s)
- ✓ Bidirectional Configuration
- ✓ ESD Protection > 40 kilovolts
- ✓ Available in 5 Voltage Types: 5V to 24V
- ✓ Standard Dual-In-Line Package
- ✓ Protects up to 8 Lines
- ✓ Low Capacitance: 15pF
- ✓ RoHS Compliant

## MECHANICAL CHARACTERISTICS

- ✓ Molded 16 Pin Dual-In-Line (DIP) Package
- ✓ Weight 1.2 grams (Approximate)
- ✓ Available in Lead-Free Pure-Tin Plating(Annealed)
- ✓ Solder Reflow Temperature:  
Pure-Tin - Sn, 100: 260-270°C
- ✓ Consult Factory for Leaded Device Availability
- ✓ Flammability Rating UL 94V-0
- ✓ Packaging: 25 Pieces Per Tube
- ✓ Marking: Logo, Part Number, Date Code & Pin One Defined By Dot on Top of Package

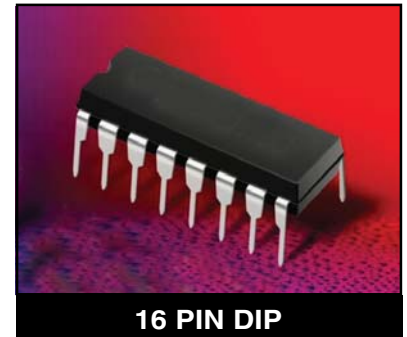

## PIN CONFIGURATION

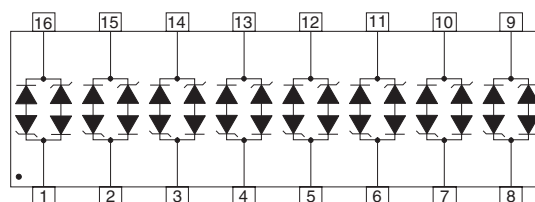

# LCD05C thru LCD24C

## DEVICE CHARACTERISTICS

### MAXIMUM RATINGS @ 25°C Unless Otherwise Specified

PARAMETER	SYMBOL	VALUE	UNITS
Peak Pulse Power ( $t_p = 8/20\mu s$ ) - See Figure 1	$P_{PP}$	800	Watts
Operating Temperature	$T_L$	-55 to 150	°C
Storage Temperature	$T_{STG}$	-55 to 150	°C

### ELECTRICAL CHARACTERISTICS PER LINE @ 25°C Unless Otherwise Specified

PART NUMBER (See Note 1)	RATED STAND-OFF VOLTAGE $V_{WM}$ VOLTS	MINIMUM BREAKDOWN VOLTAGE @ 1mA $V_{(BR)}$ VOLTS	MAXIMUM CLAMPING VOLTAGE (See Fig. 2) @ $I_p = 1A$ $V_C$ VOLTS	MAXIMUM CLAMPING VOLTAGE (See Fig. 2) @ 8/20 $\mu s$ $V_C$ @ $I_{PP}$	MAXIMUM LEAKAGE CURRENT @ $V_{WM}$ $I_b$ $\mu A$	MAXIMUM CAPACITANCE 0V @ 1 MHz C pF	TEMPERATURE COEFFICIENT OF $V_{(BR)}$  qV <sub>(BR)</sub> mV/°C
LCD05C	5.0	6.0	9.8	24V @ 45A	100	15	3
LCD08C	8.0	8.5	12.3	25.5V @ 40A	10	15	9
LCD12C	12.0	13.3	19.0	32V @ 34A	4	15	16
LCD15C	15.0	16.7	25.5	38V @ 27A	4	15	17
LCD24C	24.0	26.7	40.0	48V @ 22A	4	15	26

Note 1: Tested on pin pairs 1 & 16, 2 & 15, 3 & 14, 4 & 13, 5 & 12, 6 & 11, 7 & 10 and 8 & 9.

FIGURE 1  
PEAK PULSE POWER VS PULSE TIME

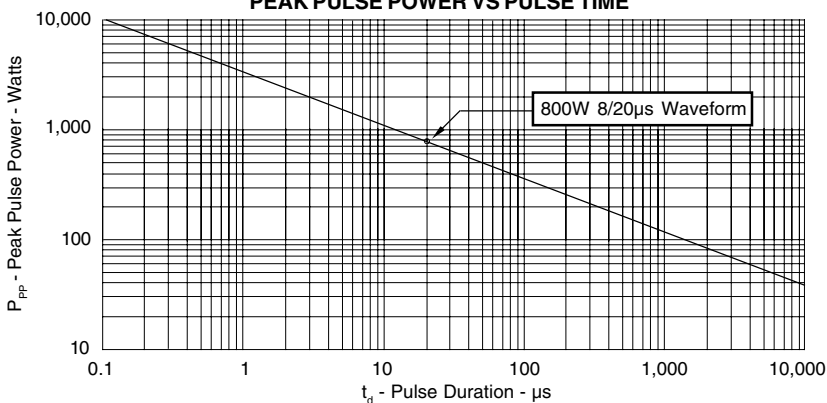
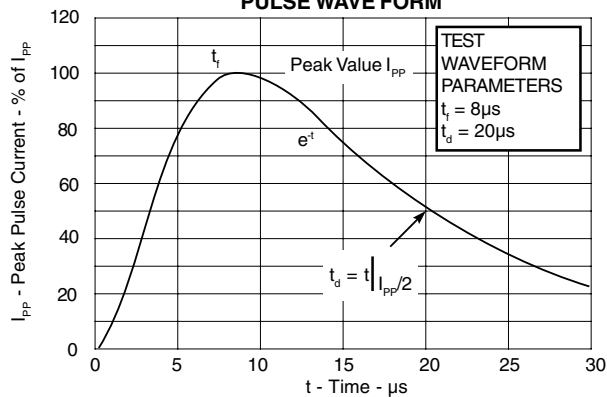
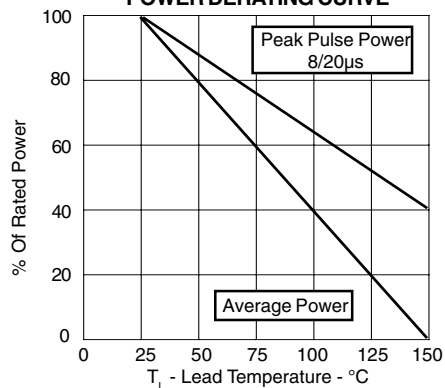

FIGURE 2  
PULSE WAVE FORM



GRAPHS

**FIGURE 3  
 POWER DERATING CURVE**



**FIGURE 4  
 OVERSHOOT & CLAMPING VOLTAGE FOR LCD05C**

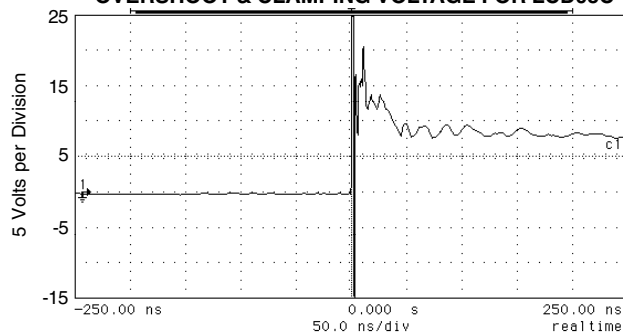

**FIGURE 5  
 TYPICAL CLAMPING VOLTAGE VS PEAK PULSE CURRENT FOR LCD05C**

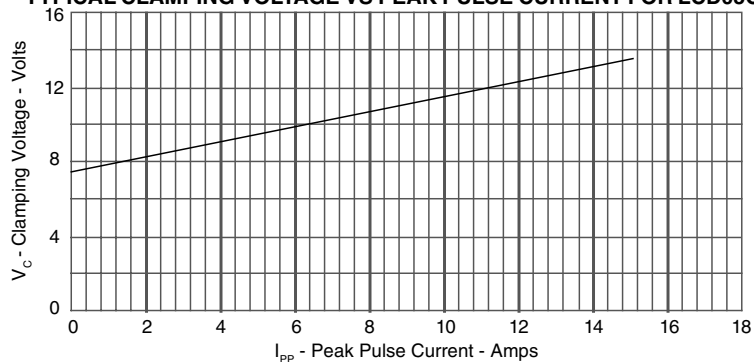

## APPLICATION NOTE

The LCD Series are low capacitance, bidirectional TVS arrays that are designed to protect I/O or high speed data lines from the damaging effects of ESD or EFT. This product series has a surge capability of 800 Watts  $P_{pp}$  per line for an 8/20 $\mu$ s waveshape and offers ESD protection > 40kV.

### BIDIRECTIONAL COMMON-MODE CONFIGURATION (Figure 1)

Ideal for use in USB applications, the LCD Series provides up to eight (8) lines of protection in a common-mode configuration as depicted in Figure 1.

Circuit connectivity is as follows:

- ✓ Pins 2, 3, 4, 5, 6, and 7 are connected to ground.
- ✓ Pins 15 and 14 connected to Port #1 D- and D+.
- ✓ Pins 13 and 12 connected to Port #2 D+ and D-.
- ✓ Pins 11 and 10 connected to Port #3 D+ and D-.

### CIRCUIT BOARD LAYOUT RECOMMENDATIONS

Circuit board layout is critical for Electromagnetic Compatibility (EMC) protection. The following guidelines are recommended:

- ✓ The protection device should be placed near the input terminals or connectors. By placing the TVS close to the connectors, the device will divert the transient current immediately before it can be coupled into the nearby traces.
- ✓ The path length between the TVS devices and the protected line should be minimized
- ✓ All conductive loops including power and ground loops should be minimized
- ✓ The transient current return path to ground should be kept as short as possible to reduce parasitic inductance.
- ✓ Ground planes should be used whenever possible. For Multilayer PCBs, use ground vias.

Figure1. Typical Common- Mode USB Protection Circuit

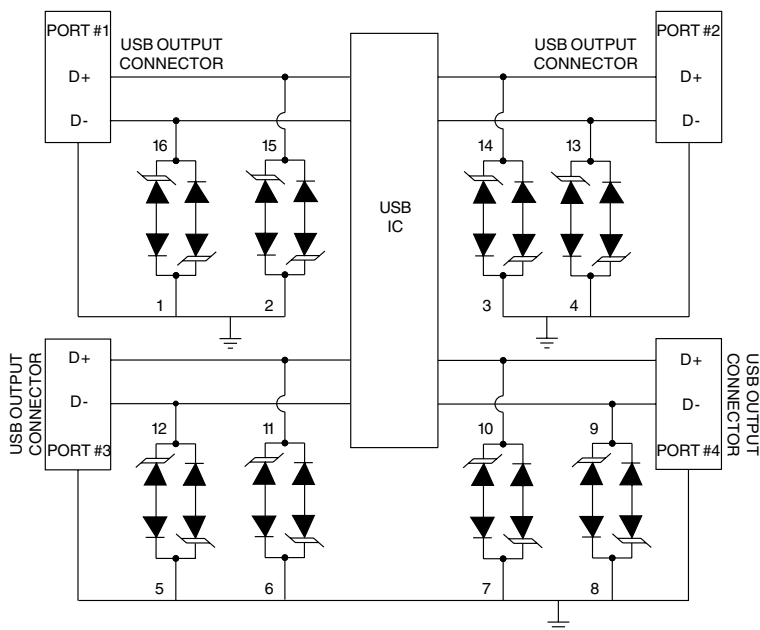

# LCD05C thru LCD24C

## 16 PIN DIP PACKAGE OUTLINE & DIMENSIONS

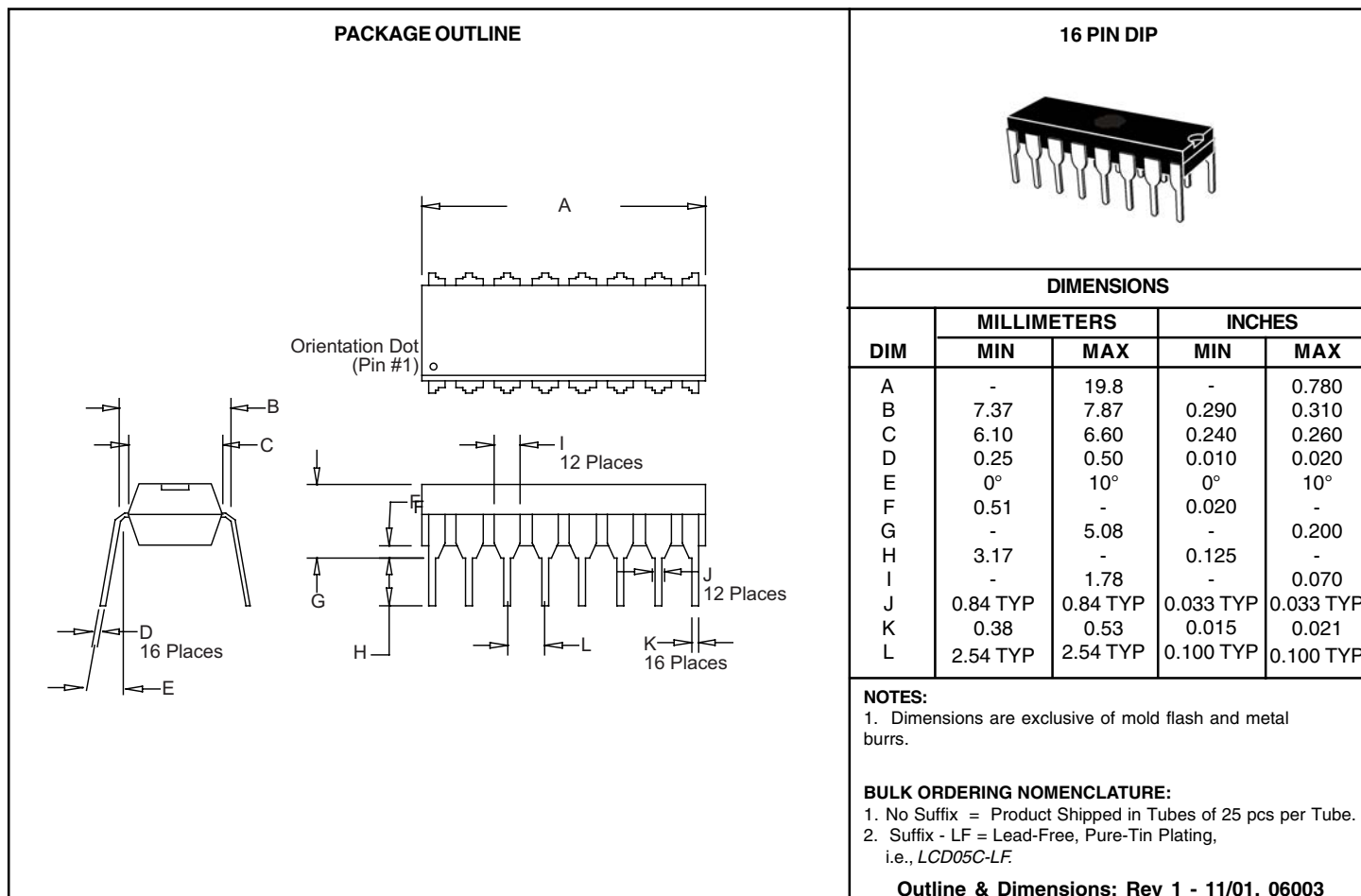

**COPYRIGHT © ProTek Devices 2007**

SPECIFICATIONS: ProTek reserves the right to change the electrical and or mechanical characteristics described herein without notice (except JEDEC).

DESIGN CHANGES: ProTek reserves the right to discontinue product lines without notice, and that the final judgement concerning selection and specifications is the buyer's and that in furnishing engineering and technical assistance, ProTek assumes no responsibility with respect to the selection or specifications of such products.

**ProTek Devices**  
2929 South Fair Lane, Tempe, AZ 85282  
Tel: 602-431-8101 Fax: 602-431-2288  
E-Mail: [sales@protekdevices.com](mailto:sales@protekdevices.com)  
Web Site: [www.protekdevices.com](http://www.protekdevices.com)